



US00D579433S

(12) **United States Design Patent**  
**Han et al.**

(10) **Patent No.:** **US D579,433 S**  
(45) **Date of Patent:** **\*\* Oct. 28, 2008**

(54) **MOBILE PHONE**

(75) Inventors: **Woo-Seung Han**, Seoul (KR);  
**Seog-Guen Kim**, Seoul (KR); **Tae-Ho Kim**,  
Yongin-si (KR); **Sung-Kyun Bai**, Seoul (KR);  
**Yun-Su Kim**, Seoul (KR)

(73) Assignee: **Samsung Electronics Co., Ltd.**,  
Suwon-Si (KR)

(\*\*) Term: **14 Years**

(21) Appl. No.: **29/290,233**

(22) Filed: **Nov. 7, 2007**

(30) **Foreign Application Priority Data**

Aug. 10, 2007 (KR) ..... 30-2007-0034501

(51) **LOC (8) Cl.** ..... **14-03**

(52) **U.S. Cl.** ..... **D14/138**

(58) **Field of Classification Search** ..... D14/137,  
D14/138, 147, 191, 218, 247-248, 341-347,  
D14/496; D10/65, 78, 104; D13/168; D18/7;  
455/556.1, 566, 575.1, 575.3; 345/169  
See application file for complete search history.

(56) **References Cited**

**U.S. PATENT DOCUMENTS**

D502,703	S	*	3/2005	Tsujimoto et al.	.....	D14/346
D526,222	S	*	8/2006	Uehara	.....	D10/65
D531,608	S	*	11/2006	Kim et al.	.....	D14/138
D531,611	S	*	11/2006	Kim et al.	.....	D14/138
7,200,224	B2	*	4/2007	Park et al.	.....	379/433.13
D541,785	S	*	5/2007	Hwang et al.	.....	D14/138
D543,188	S	*	5/2007	Minamide et al.	.....	D14/138
D544,460	S	*	6/2007	Yau	.....	D14/138
D551,647	S	*	9/2007	Kim et al.	.....	D14/138
D554,098	S	*	10/2007	Lee	.....	D14/138
D559,220	S	*	1/2008	Lee et al.	.....	D14/138
D560,192	S	*	1/2008	Lee et al.	.....	D14/138
D562,285	S	*	2/2008	Lim	.....	D14/138
D563,935	S	*	3/2008	Kim et al.	.....	D14/138
D563,938	S	*	3/2008	Kim et al.	.....	D14/138

D565,596	S	*	4/2008	Kim	.....	D14/496
D567,819	S	*	4/2008	Devericks et al.	.....	D14/496
D568,286	S	*	5/2008	Suk et al.	.....	D14/138
D569,837	S	*	5/2008	Baik et al.	.....	D14/138
2005/0250532	A1	*	11/2005	Hwang et al.	.....	455/550.1
2006/0093133	A1	*	5/2006	Park et al.	.....	379/433.12
2007/0060072	A1	*	3/2007	Sung et al.	.....	455/90.3
2007/0123322	A1	*	5/2007	Mizushina	.....	455/575.1
2008/0004083	A1	*	1/2008	Ohki et al.	.....	455/566
2008/0070635	A1	*	3/2008	Bang et al.	.....	455/566
2008/0119237	A1	*	5/2008	Kim	.....	455/566

**OTHER PUBLICATIONS**

LG KE850 Prada, announced Jan. 2007, [online], [retrieved on Feb. 20, 2007]. Retrieved from Internet ,<URL: http://www.gsmarena.com>.\*

(Continued)

*Primary Examiner*—Jeffrey D. Asch  
*Assistant Examiner*—Bridget L Eland

(74) *Attorney, Agent, or Firm*—Staas & Halsey LLP

(57) **CLAIM**

The ornamental design for a mobile phone, as shown and described.

**DESCRIPTION**

FIG. 1 is a perspective view of a mobile phone;  
FIG. 2 is a front view of the mobile phone of FIG. 1;  
FIG. 3 is a rear view of the mobile phone of FIG. 1;  
FIG. 4 is left-side of the mobile phone of FIG. 1;  
FIG. 5 is right-side of the mobile phone of FIG. 1;  
FIG. 6 is top plan view of the mobile phone of FIG. 1;  
FIG. 7 is bottom plan view of the mobile phone of FIG. 1;  
FIG. 8 is an open perspective view of the mobile phone of FIG. 1; and,  
FIG. 9 is a rear perspective view of the mobile phone of FIG. 1, displaying a digital camera unit on the back.

**1 Claim, 7 Drawing Sheets**

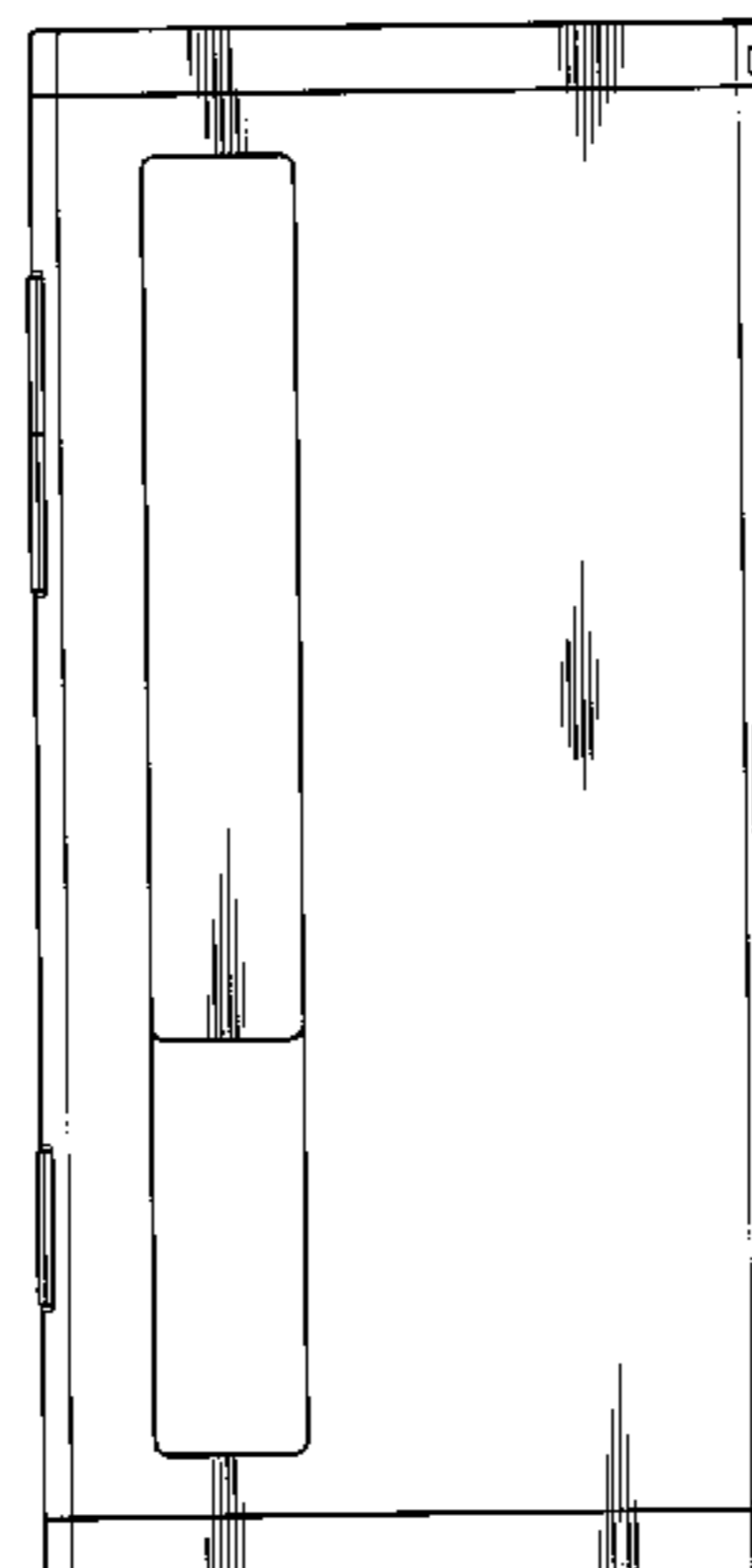
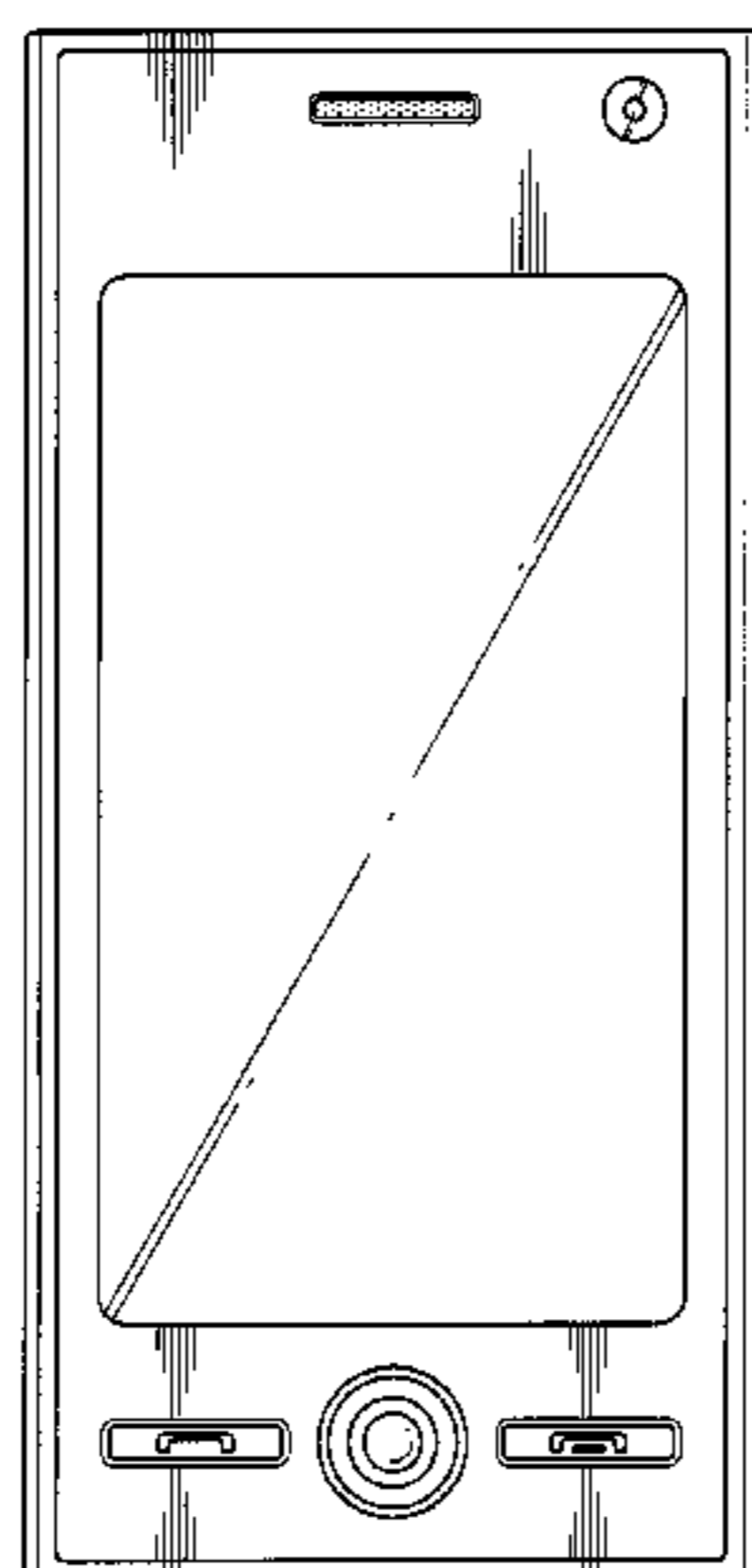

OTHER PUBLICATIONS

LG KS20, announced Sep. 2007, [online], [retrieved on Dec. 13, 2007]. Retrieved from Internet ,<URL: <http://www.gsmarena.com>>.\*

Samsung F490, announced Jan. 2008, [online], [retrieved on Jan. 18, 2008]. Retrieved from Internet ,<URL: <http://www.gsmarena.com>>.\*

\* cited by examiner

FIG. 1

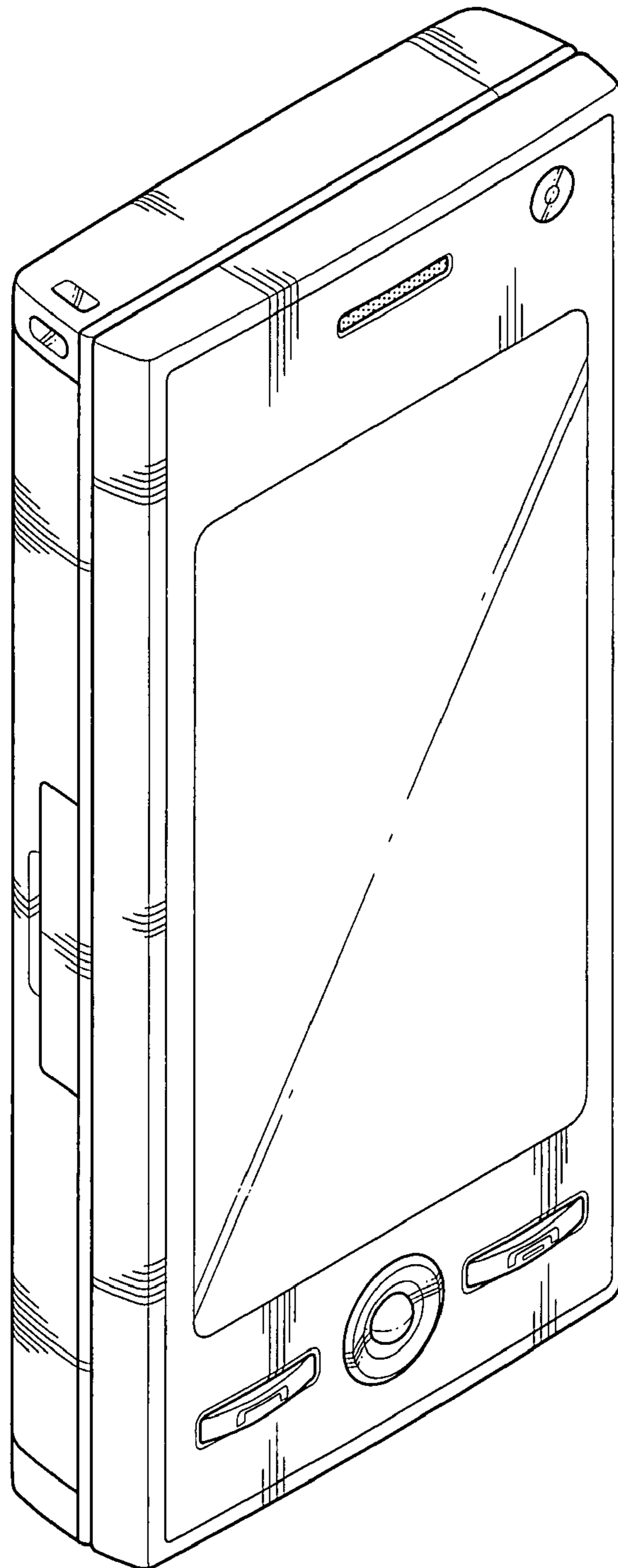

# FIG. 2

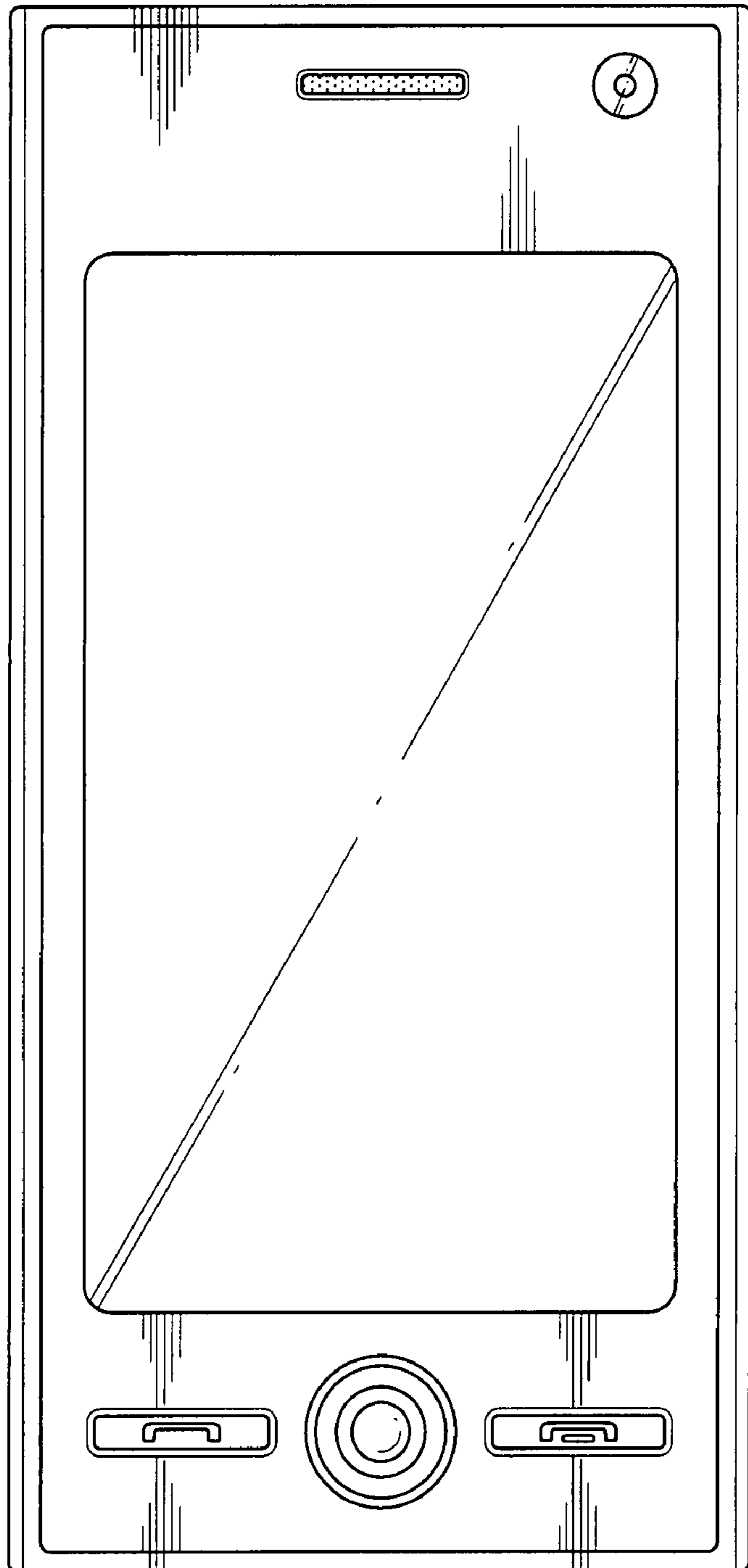

FIG. 3

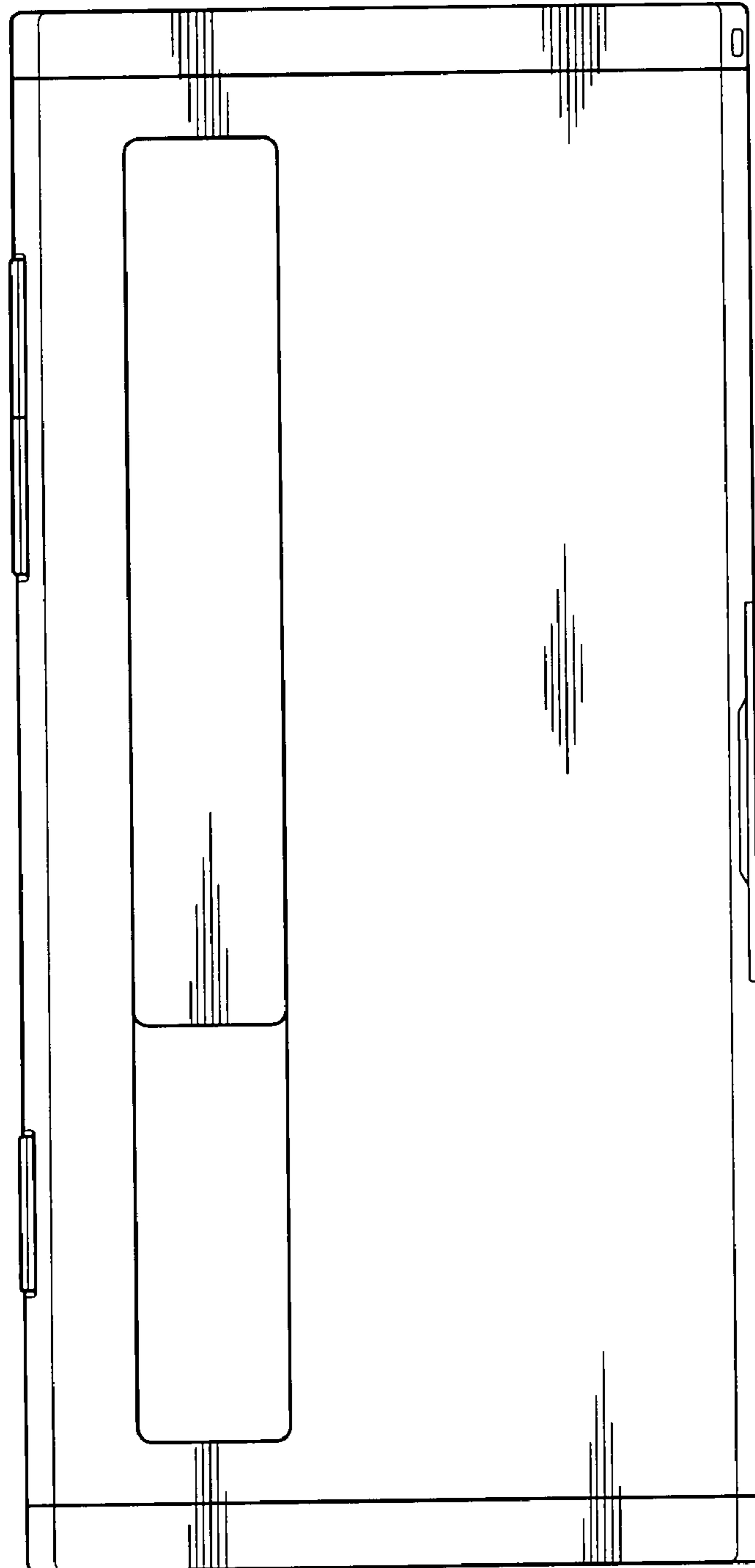

FIG. 4

FIG. 5

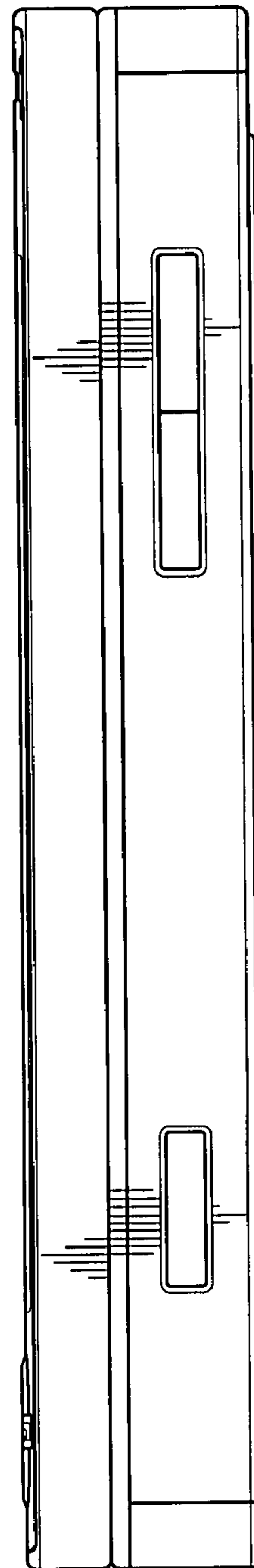
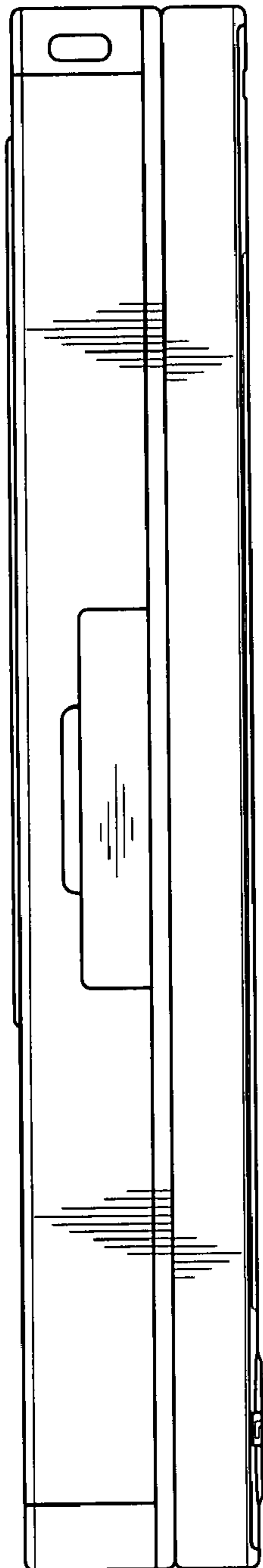

FIG. 6

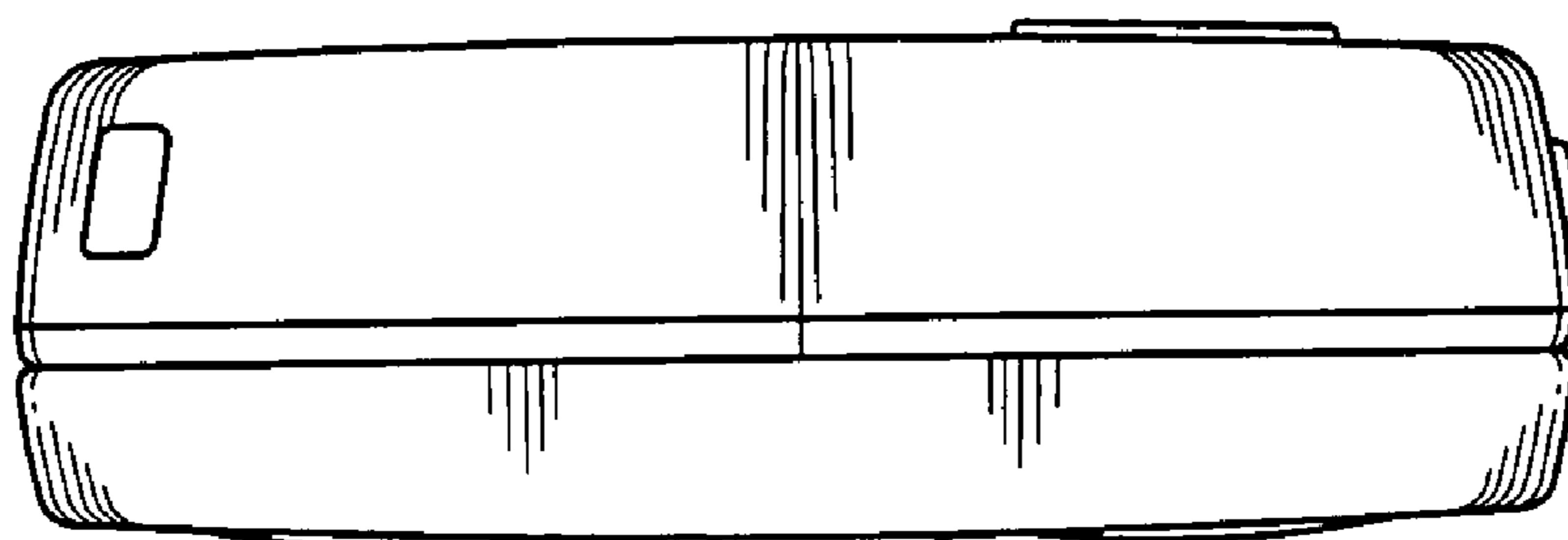

FIG. 7



FIG. 8

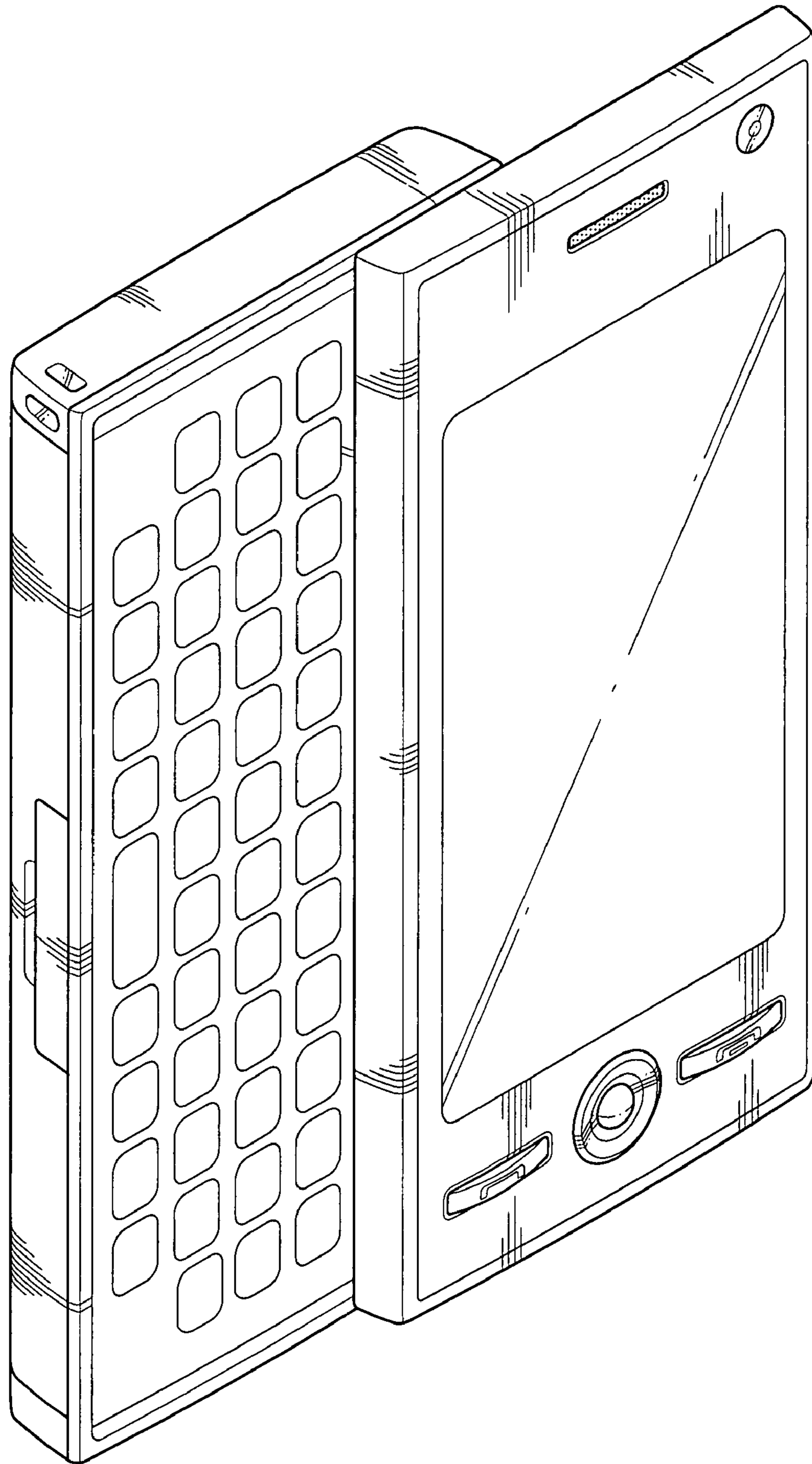



FIG. 9

