



US00D579310S

(12) **United States Design Patent**  
**Suh et al.**

(10) **Patent No.:** **US D579,310 S**  
(45) **Date of Patent:** **\*\* Oct. 28, 2008**

(54) **HANDLE**

(75) Inventors: **Seung Wook Suh**, Seoul (KR); **Sei Ill Jeon**, Seoul (KR); **Andy Shin**, Seoul (KR); **Dong Won Chun**, Seoul (KR)

(73) Assignee: **Samsung Electronics Co., Ltd.**, Suwon (KR)

(\*\*) Term: **14 Years**

(21) Appl. No.: **29/291,697**

(22) Filed: **Sep. 11, 2007**

(51) **LOC (8) Cl.** ..... **08-06**

(52) **U.S. Cl.** ..... **D8/315**; D15/89

(58) **Field of Classification Search** ..... D8/300–303, D8/305–321, DIG. 1, DIG. 2, DIG. 10; D7/393, D7/394, 405; D3/318; D6/549, 524, 533, D6/550; D23/250–254, 303, 305; D15/89; 292/347, 336.3; 211/16, 182; 220/752–754; 16/441, 118, 110 R, 111 R, DIG. 19, DIG. 30, 16/110.1, 412, 414–420, 443–446  
See application file for complete search history.

(56) **References Cited**

**U.S. PATENT DOCUMENTS**

D99,252 S *	4/1936	Tjaarda	.....	D8/317
D116,604 S *	9/1939	Hefferan	.....	D8/319
D164,256 S *	8/1951	North	.....	D8/319
D175,751 S *	10/1955	Aleks	.....	D8/317
D181,671 S *	12/1957	Petkwikz	.....	D8/319
D199,839 S *	12/1964	Simpson	.....	D8/316
D218,619 S *	9/1970	Young	.....	D8/316
D266,122 S *	9/1982	Haug	.....	D8/316
D370,617 S *	6/1996	Decursu et al.	.....	D8/316
D400,424 S *	11/1998	Lewis et al.	.....	D8/316
D449,215 S *	10/2001	Bertani	.....	D8/316
6,546,597 B2 *	4/2003	Atalla et al.	.....	16/436
D495,556 S *	9/2004	Milrud et al.	.....	D7/405
D511,955 S *	11/2005	Baldwin et al.	.....	D8/301

D537,849 S *	3/2007	Wong et al.	.....	D15/89
D539,994 S *	4/2007	Pezzetta et al.	.....	D32/3
D541,132 S *	4/2007	Huxhold et al.	.....	D8/316
D542,090 S *	5/2007	Kim et al.	.....	D7/402
D546,623 S *	7/2007	Kim et al.	.....	D7/402
D554,972 S *	11/2007	Pezzetta	.....	D8/319
D556,794 S *	12/2007	Vaughn et al.	.....	D15/89
D562,360 S *	2/2008	Choi	.....	D15/89
D565,351 S *	4/2008	Crookshanks et al.	.....	D7/405
D565,892 S *	4/2008	McConnell et al.	.....	D7/402
D566,465 S *	4/2008	Crookshanks	.....	D7/405
D568,100 S *	5/2008	Jeon	.....	D7/402

\* cited by examiner

*Primary Examiner*—Stella M. Reid

*Assistant Examiner*—Mark A Goodwin

(74) *Attorney, Agent, or Firm*—Ladas and Parry LLP

(57) **CLAIM**

We claim the ornamental design for handle, as shown and described.

**DESCRIPTION**

FIG. 1 is a front/right-side/top perspective view of a handle showing our new design;

FIG. 2 is a front-side elevational view thereof;

FIG. 3 is a rear-side elevational view thereof;

FIG. 4 is a left-side elevational view thereof;

FIG. 5 is a right-side elevational view thereof;

FIG. 6 is a top-side elevational view thereof;

FIG. 7 is a bottom-side elevational view thereof; and,

FIG. 8 is a front-side elevational view which shows handles are positioned on the front panel of refrigerator.

The long dash short dash broken line showing of a refrigerator and the broken line showing of the extra handle in FIG. 8 is for illustrative purposes only and forms no part of the claimed design.

**1 Claim, 4 Drawing Sheets**

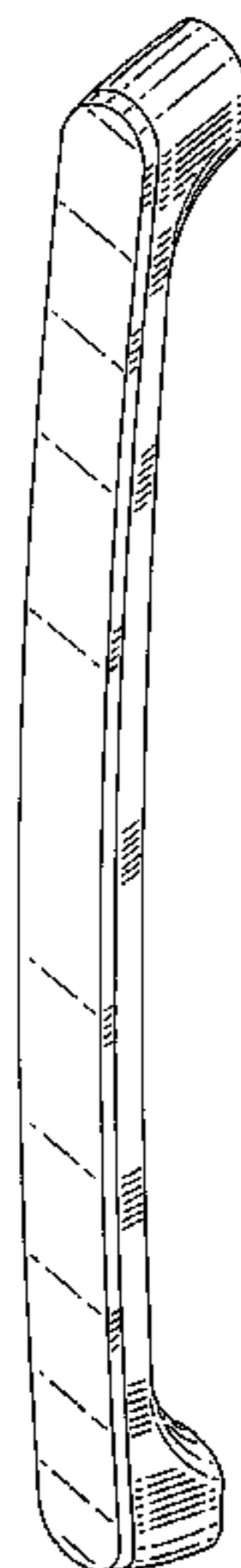

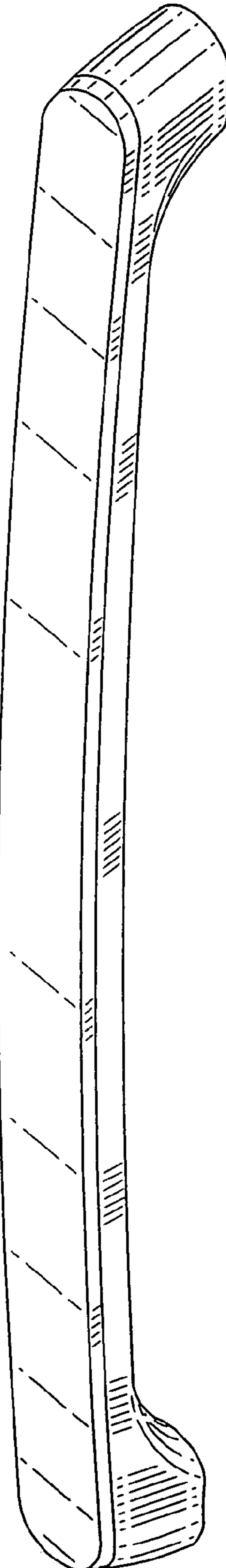

FIG. 1

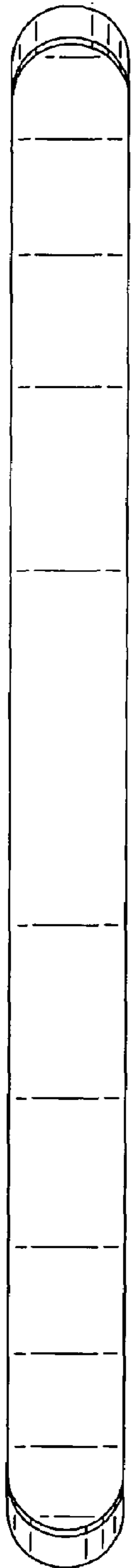

FIG. 2

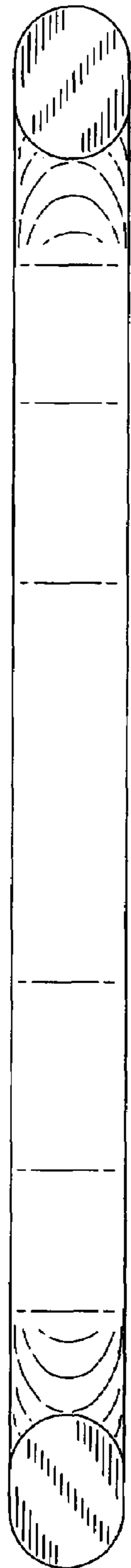

FIG. 3

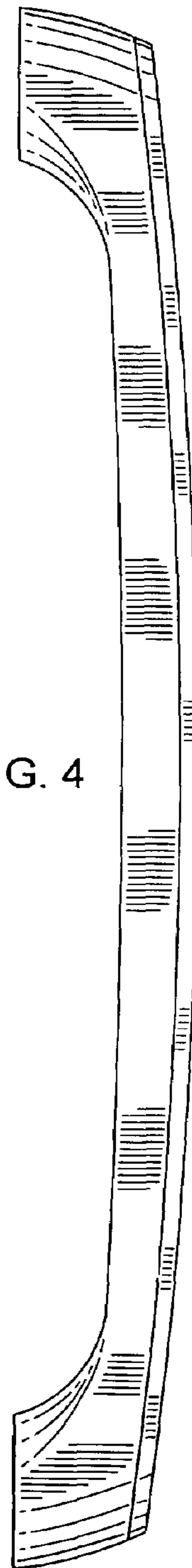

FIG. 4

FIG. 5



FIG. 6



FIG. 7

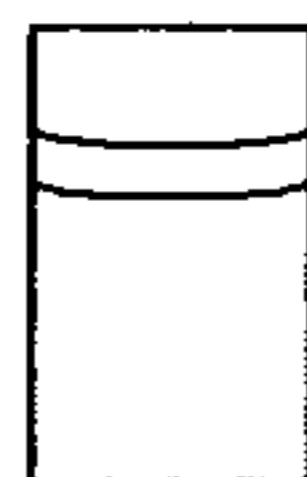

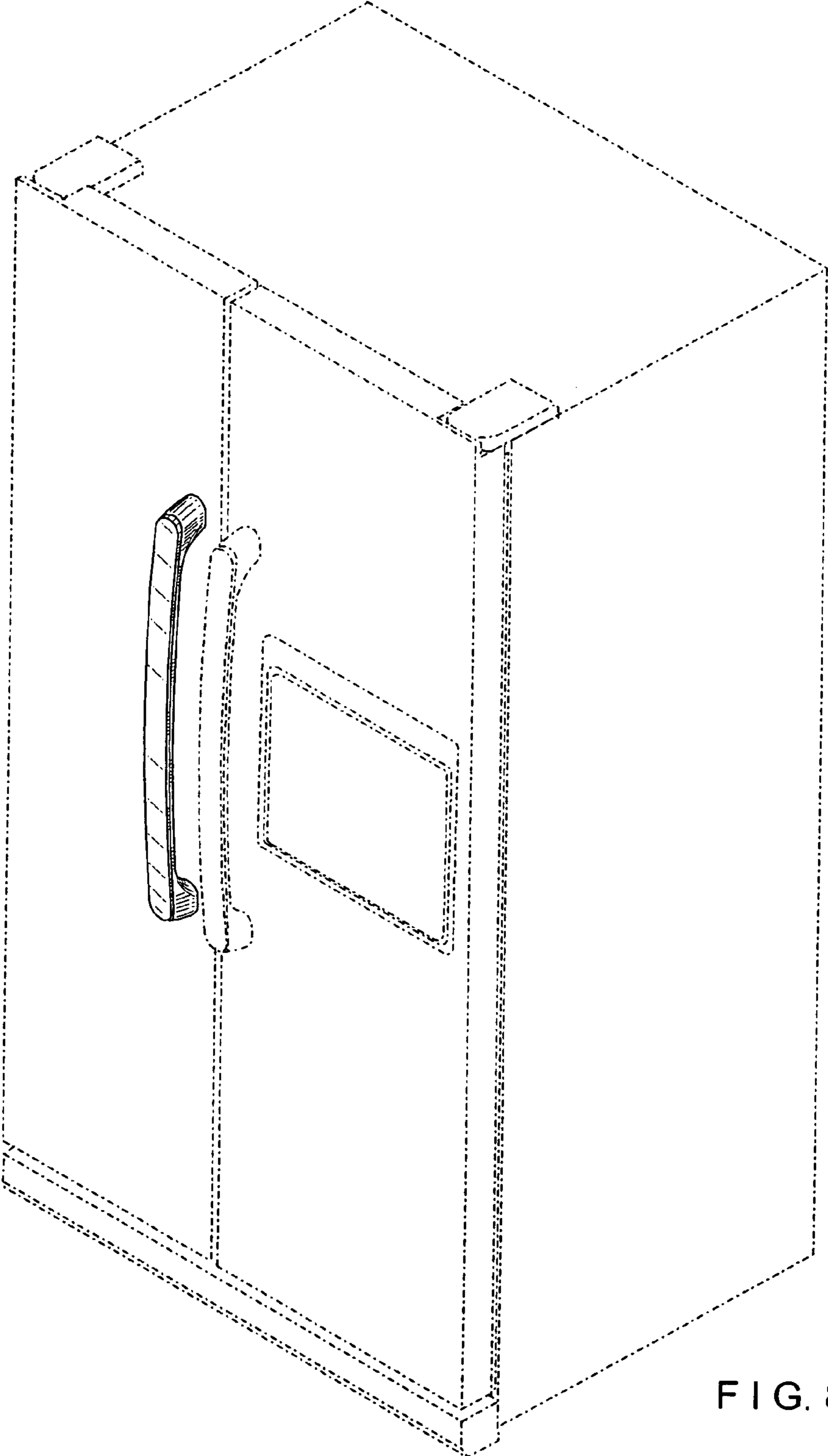

FIG. 8