



US00D579290S

(12) **United States Design Patent**
Brooke

(10) **Patent No.:** **US D579,290 S**
(45) **Date of Patent:** **** Oct. 28, 2008**

(54) **TOOL FOR CARRYING SHEET MATERIAL**

(76) Inventor: **William B. Brooke**, 10529 Oak Dr.,
Grass Valley, CA (US) 95459

(**) Term: **14 Years**

(21) Appl. No.: **29/294,904**

(22) Filed: **Jan. 31, 2008**

Related U.S. Application Data

(62) Division of application No. 29/262,006, filed on Jun. 22, 2006, now Pat. No. Des. 565,368.

(51) **LOC (8) Cl.** **08-05**

(52) **U.S. Cl.** **D8/14**

(58) **Field of Classification Search** D8/14,
D8/51, 88, 89, 107; 294/15, 19.1, 26, 27.1,
294/32

See application file for complete search history.

(56) **References Cited**

U.S. PATENT DOCUMENTS

D217,002 S *	3/1970	Wagner	D20/43
4,098,442 A *	7/1978	Moore	294/141
4,135,655 A *	1/1979	Brown	294/166
D255,317 S *	6/1980	Slinkard	D8/14
D286,972 S *	12/1986	Crews	D8/14

D288,276 S *	2/1987	Harney	D8/14
D302,234 S *	7/1989	McNamee et al.	D8/71
D317,703 S *	6/1991	Cydrus	D8/14
D349,437 S *	8/1994	Mock et al.	D8/14
D351,769 S *	10/1994	Brass et al.	D8/107
5,397,158 A *	3/1995	Brass et al.	294/15
D423,309 S *	4/2000	Sirmans	D8/14
6,520,555 B1 *	2/2003	Hamm	294/15

* cited by examiner

Primary Examiner—Philip S Hyder

(74) *Attorney, Agent, or Firm*—R. Michael West

(57) **CLAIM**

The ornamental design for a tool for carrying sheet material, as shown and described.

DESCRIPTION

FIG. 1 is a perspective view of a tool for carrying sheet material, showing my new design;

FIG. 2 is a rear elevational view, thereof;

FIG. 3 is a top plan view, thereof;

FIG. 4 is a bottom plan view, thereof;

FIG. 5 is a front elevational view, thereof; and,

FIG. 6 is an elevational view of one side, the opposite side elevational view being a mirror image, thereof.

1 Claim, 2 Drawing Sheets

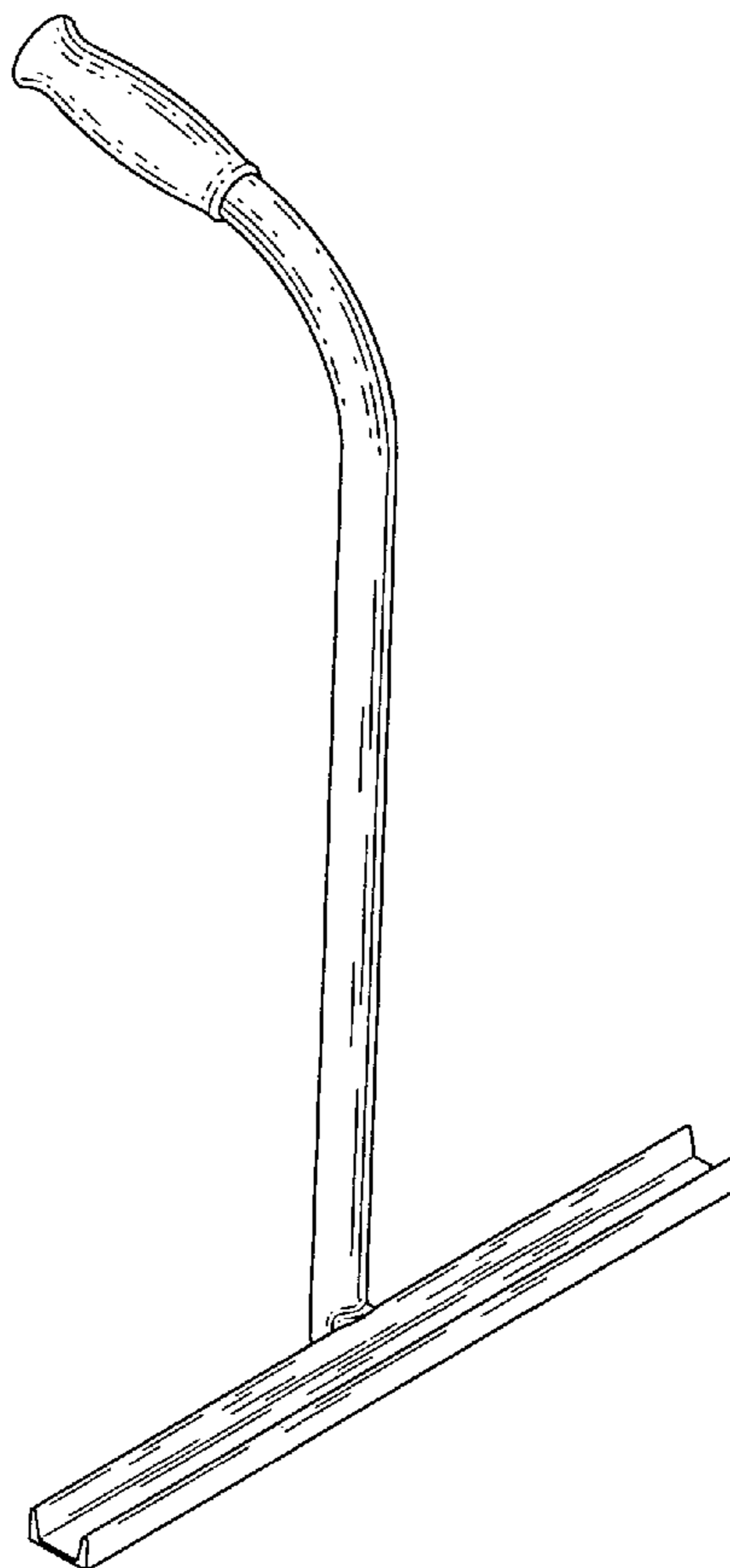

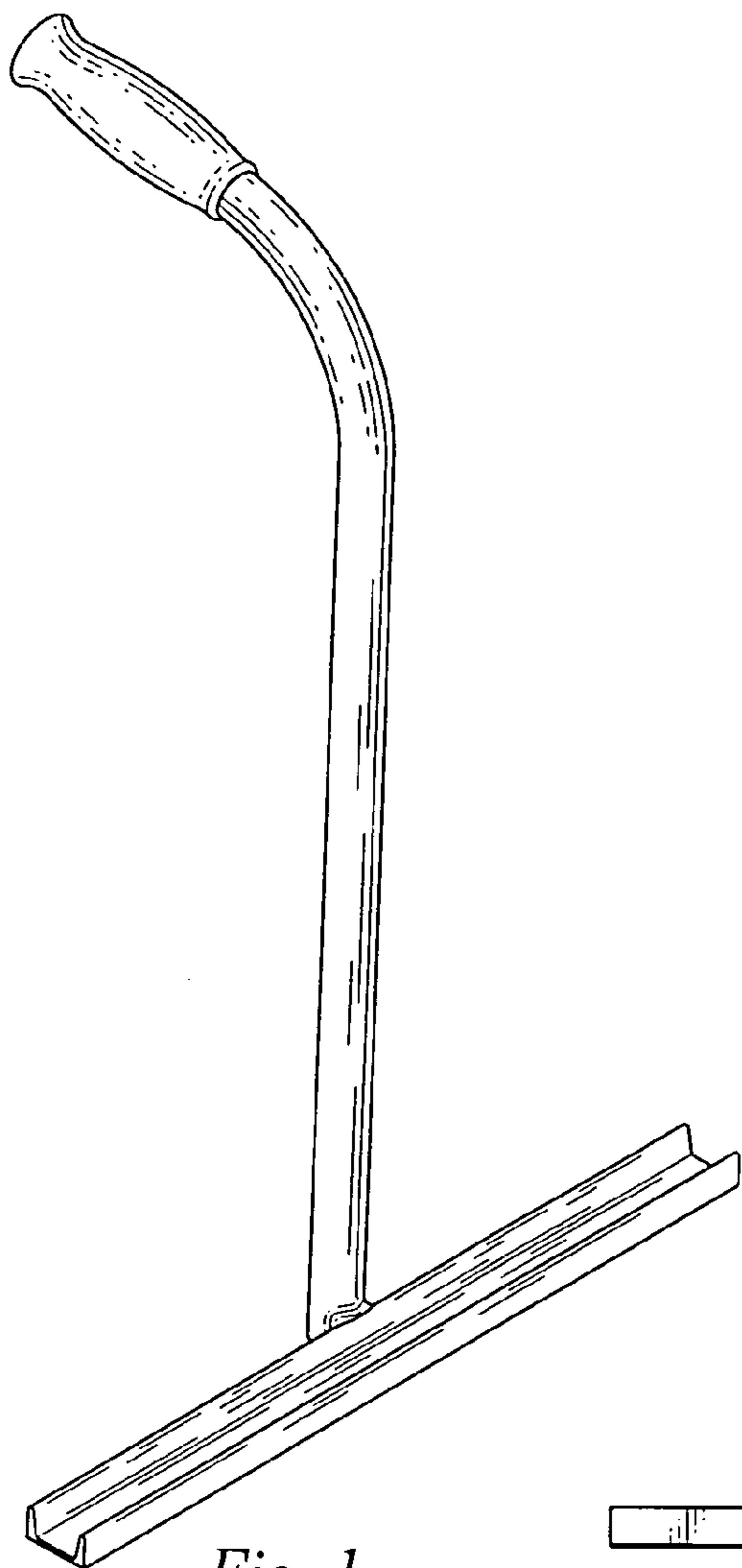

Fig. 1

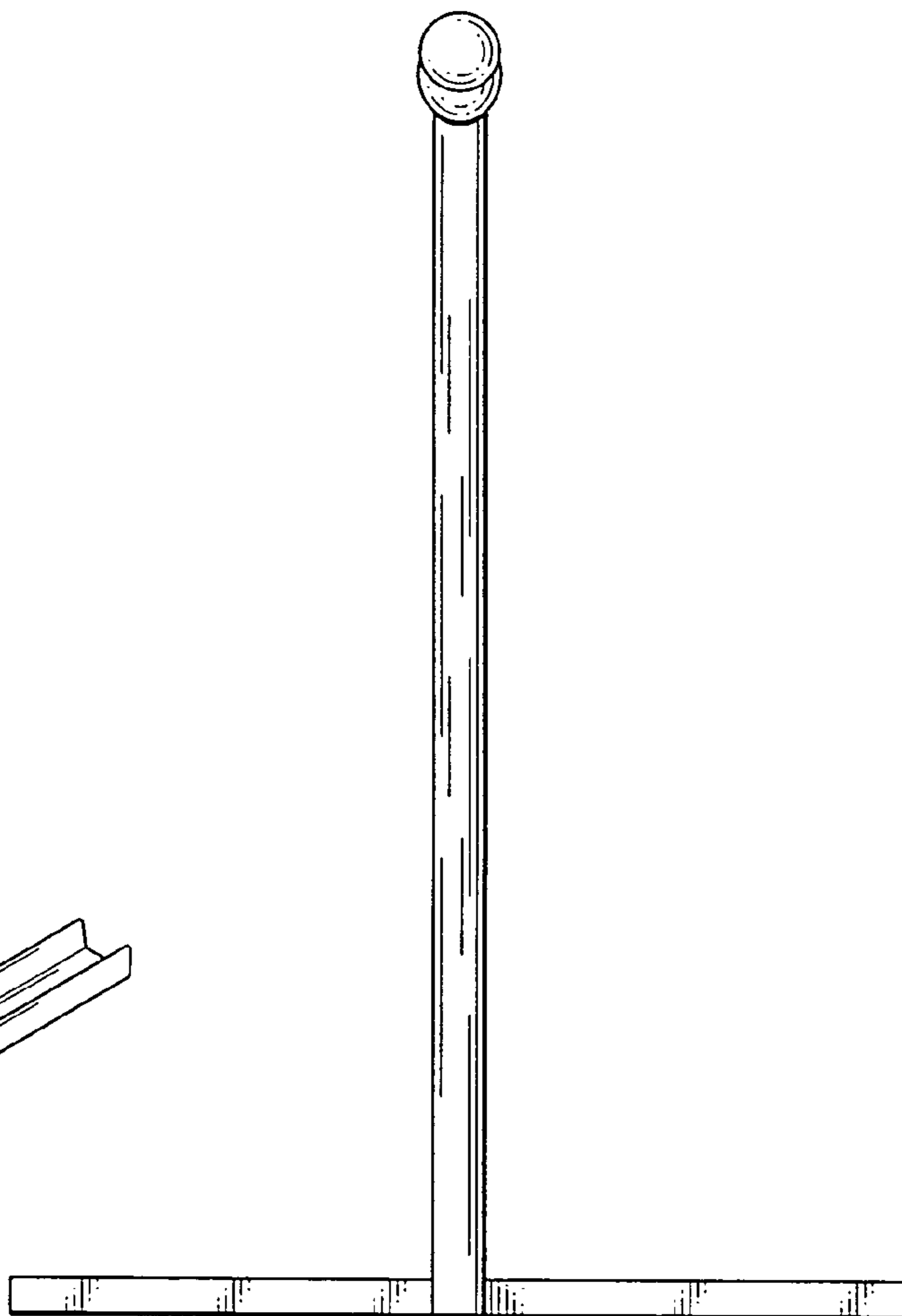

Fig. 2

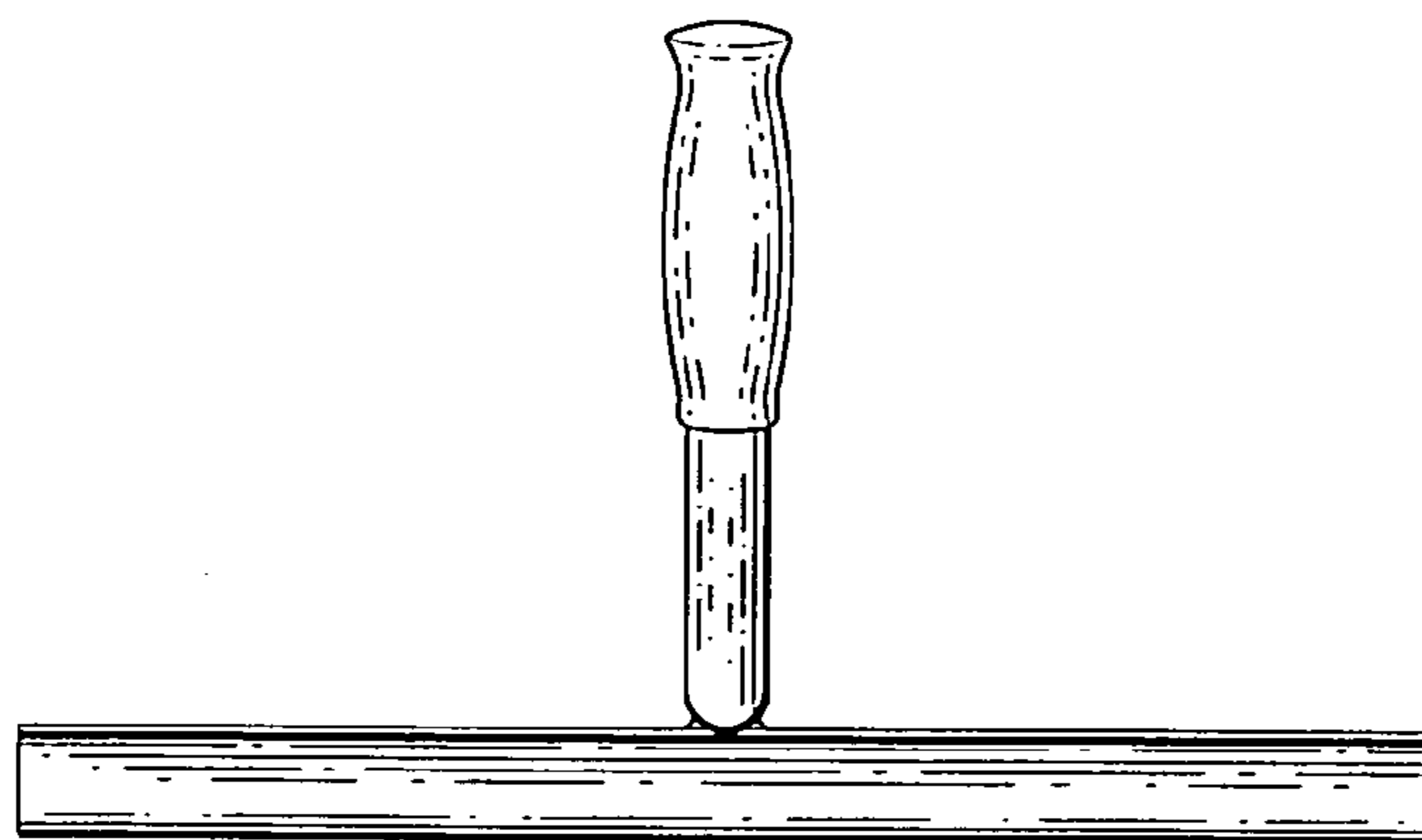

Fig. 3

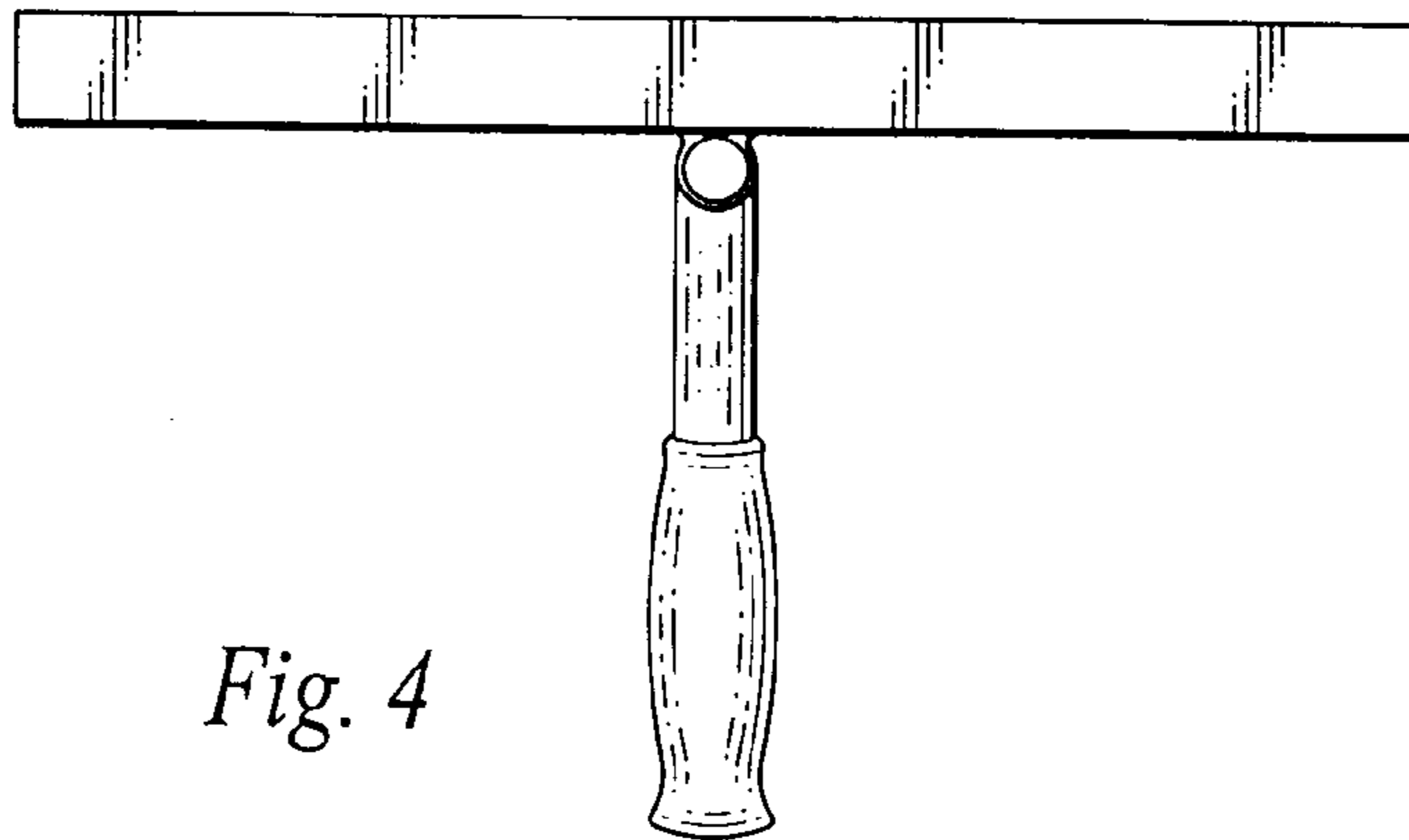

Fig. 4

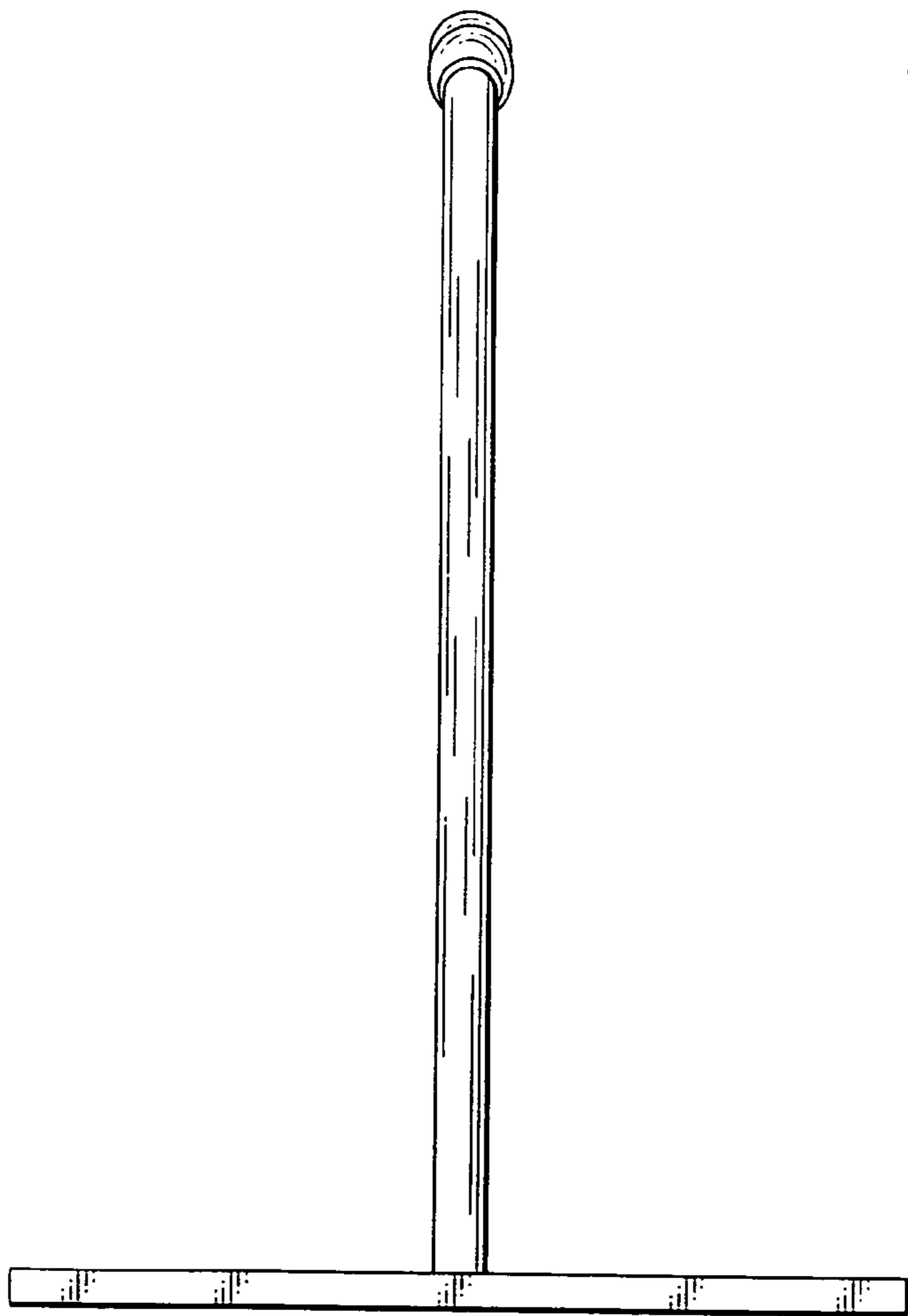

Fig. 5

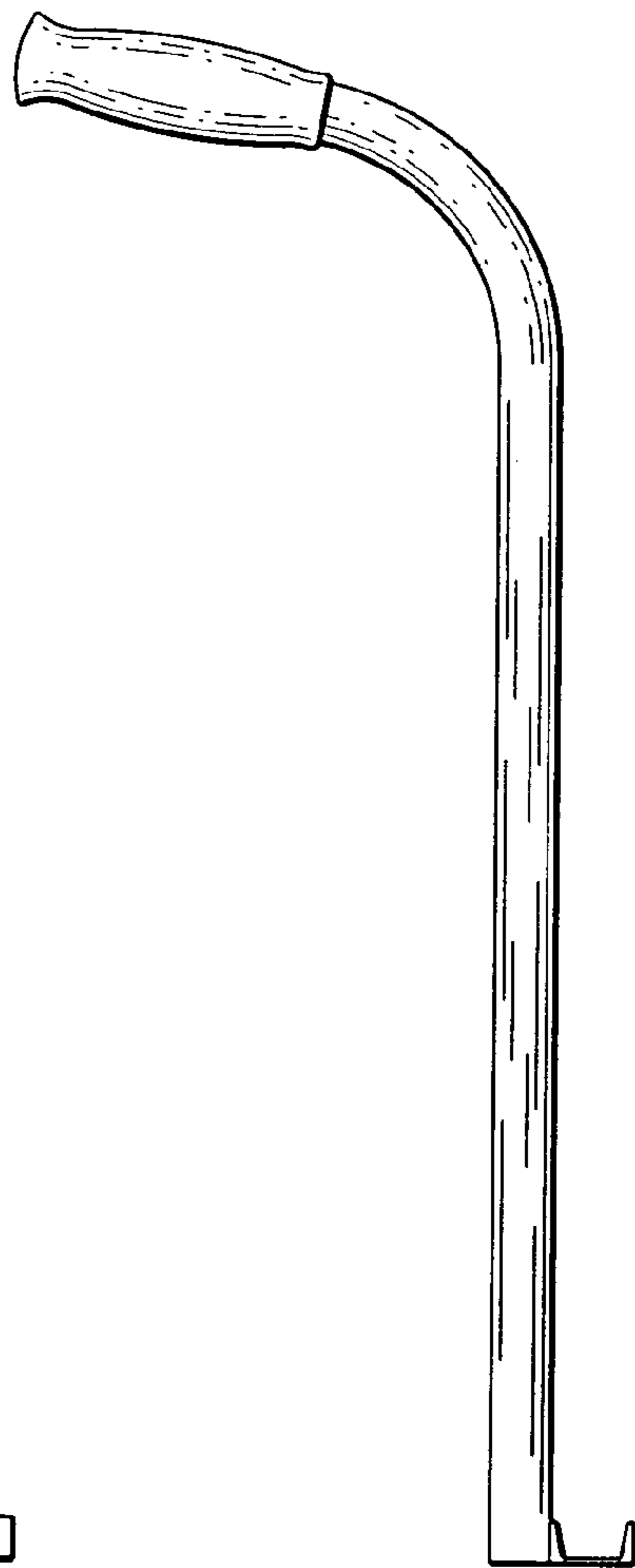

Fig. 6