



US00D579259S

(12) **United States Design Patent**
Venier

(10) **Patent No.:** **US D579,259 S**

(45) **Date of Patent:** **** Oct. 28, 2008**

(54) **CARAFE**

D299,902 S * 2/1989 Huang D7/317
D300,107 S * 3/1989 Trombly D7/317
D485,762 S * 1/2004 Ungrady D9/503

(75) Inventor: **Federico Venier**, Trieste (IT)

* cited by examiner

(73) Assignee: **Italesse Srl Company**, Muggia (Trieste)
(IT)

Primary Examiner—Marianne Pandozzi

(**) Term: **14 Years**

(74) *Attorney, Agent, or Firm*—Panitch Schwarze Belisario &
Nadel LLP

(21) Appl. No.: **29/305,306**

(57) **CLAIM**

(22) Filed: **Mar. 18, 2008**

The ornamental design for a carafe, as shown and described.

Related U.S. Application Data

DESCRIPTION

(62) Division of application No. 29/235,848, filed on Aug.
8, 2005.

FIG. 1 is a perspective view of a first embodiment view of a
carafe in accordance with my new design;

(30) **Foreign Application Priority Data**

Aug. 2, 2005 (EM) 294285

FIG. 2 is a rear view thereof;

(51) **LOC (8) Cl.** **07-01**

(52) **U.S. Cl.** **D7/316; D7/537; D7/509**

(58) **Field of Classification Search** D7/316,
D7/312, 300.1, 300, 598, 537, 509; 215/6,
215/10, 400, 12.1; D11/152, 146, 157; D26/104;
D9/545, 544, 500, 503, 523, 505, 537, 552,
D9/565

FIG. 3 is a bottom plan view thereof;

FIG. 4 is a front view thereof;

FIG. 5 is a left side view thereof;

FIG. 6 is a right side view thereof;

FIG. 7 is a top plan view thereof;

FIG. 8 is a perspective view of a second embodiment of a
carafe in accordance with my new design;

See application file for complete search history.

FIG. 9 is a rear view thereof;

FIG. 10 is a bottom view thereof;

FIG. 11 is a front view thereof;

FIG. 12 is a left side view thereof;

(56) **References Cited**

U.S. PATENT DOCUMENTS

D79,467 S * 9/1929 Kelly D11/146
D211,978 S * 8/1968 Douglas D7/300
D214,831 S * 8/1969 Lomont D7/598
D230,689 S * 3/1974 Schweizer D7/598
D242,842 S * 12/1976 Wolf D7/300

FIG. 13 is a right side view thereof; and,

FIG. 14 is a top view thereof.

1 Claim, 14 Drawing Sheets

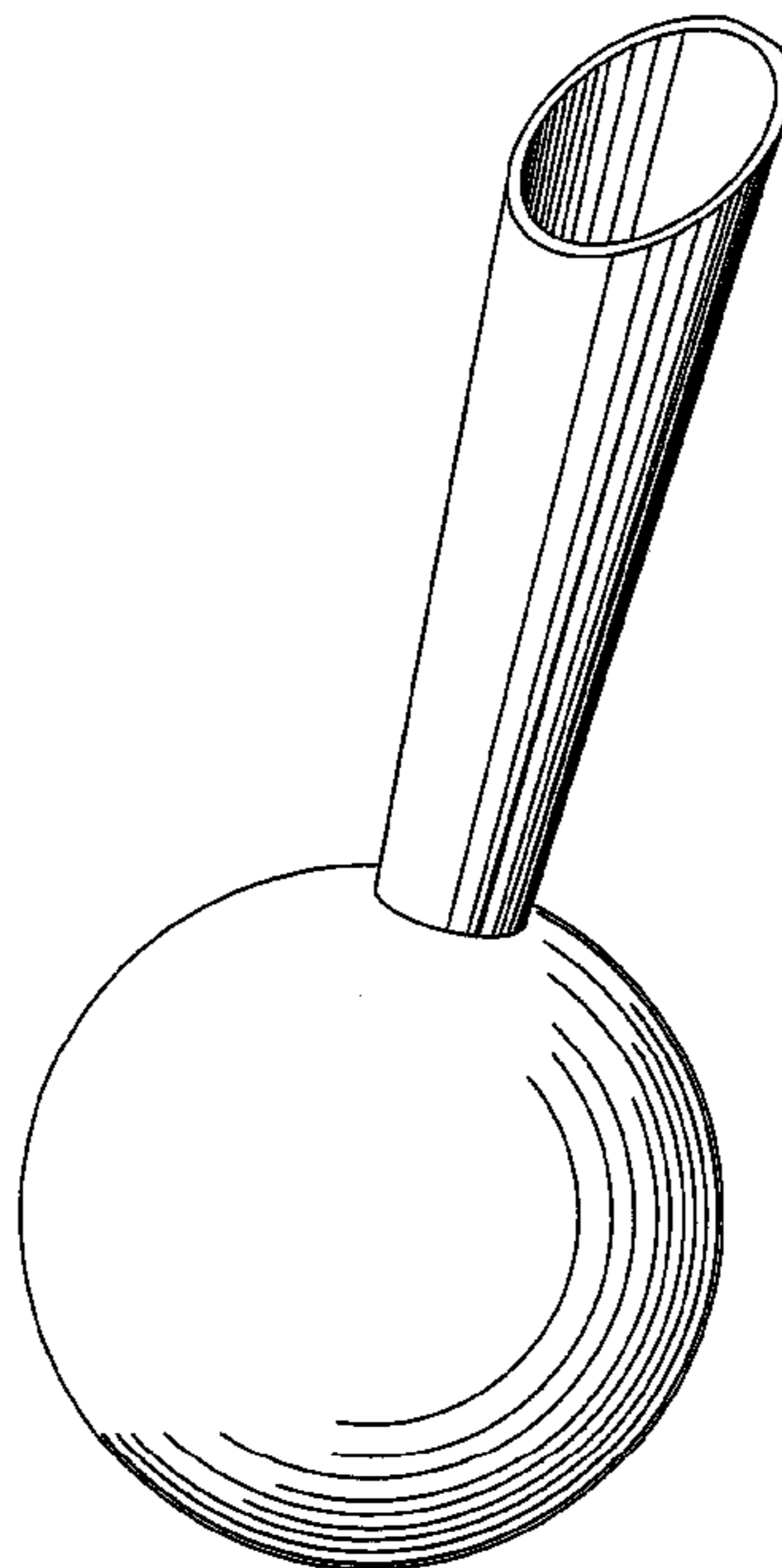

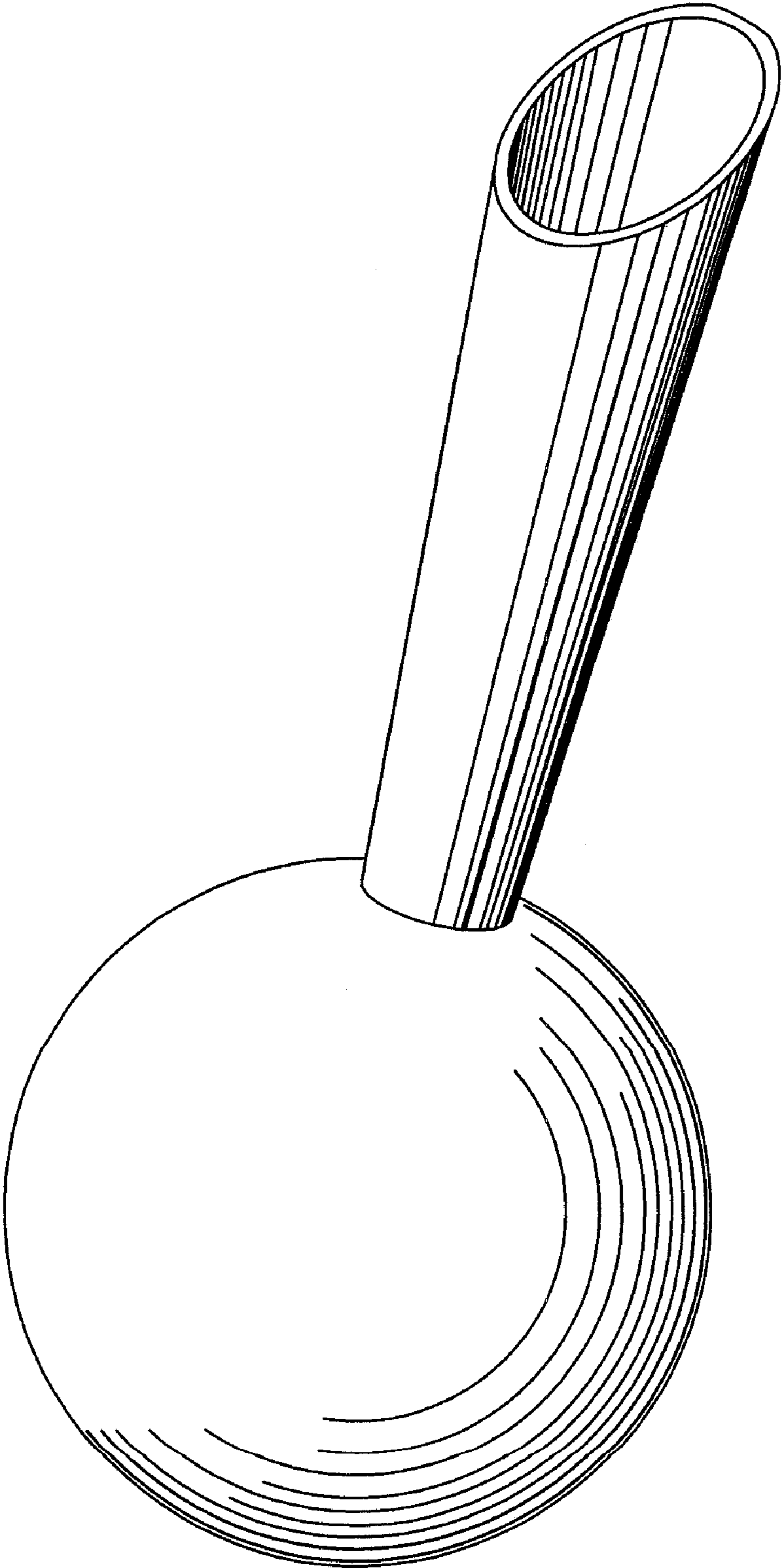

FIG. 1

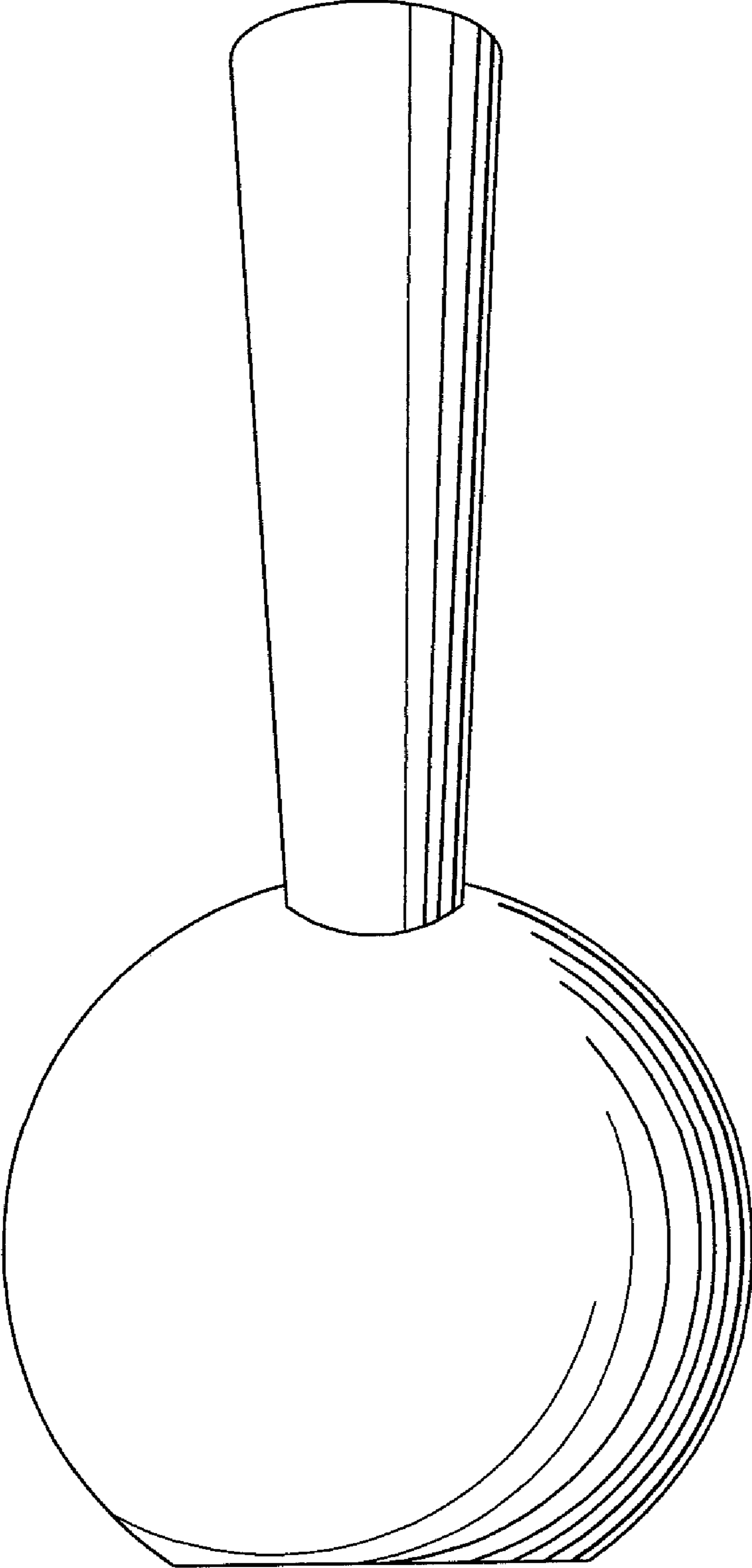

FIG. 2

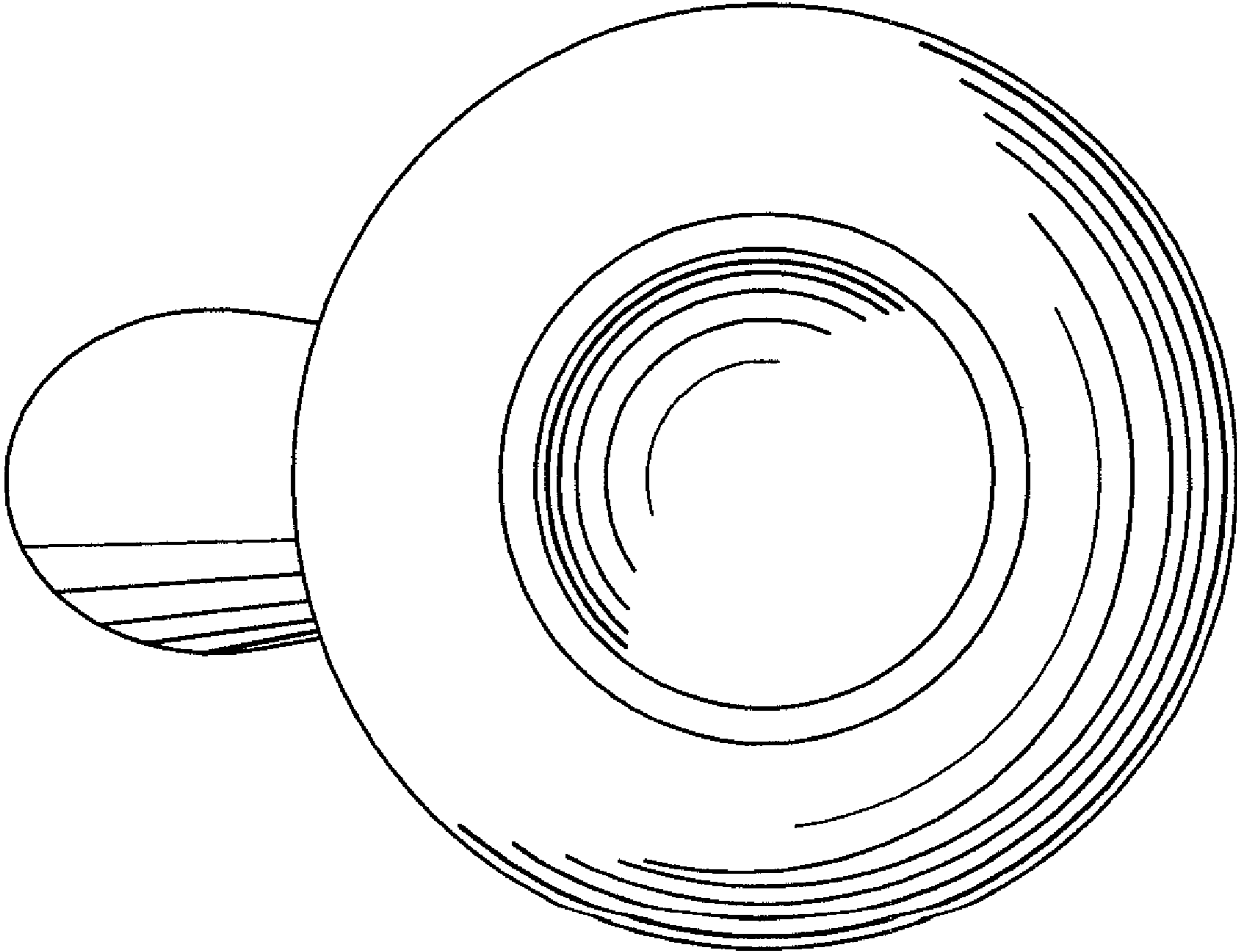

FIG. 3

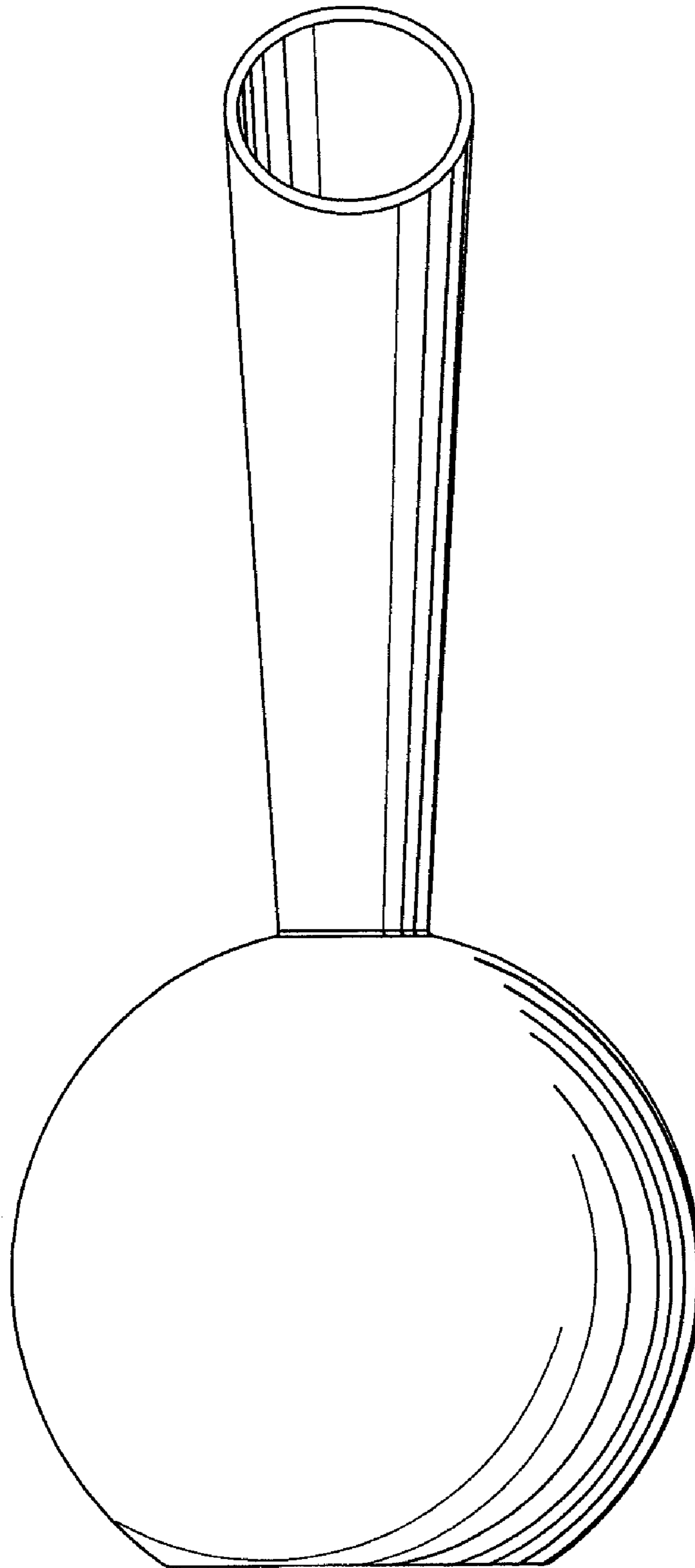

FIG. 4

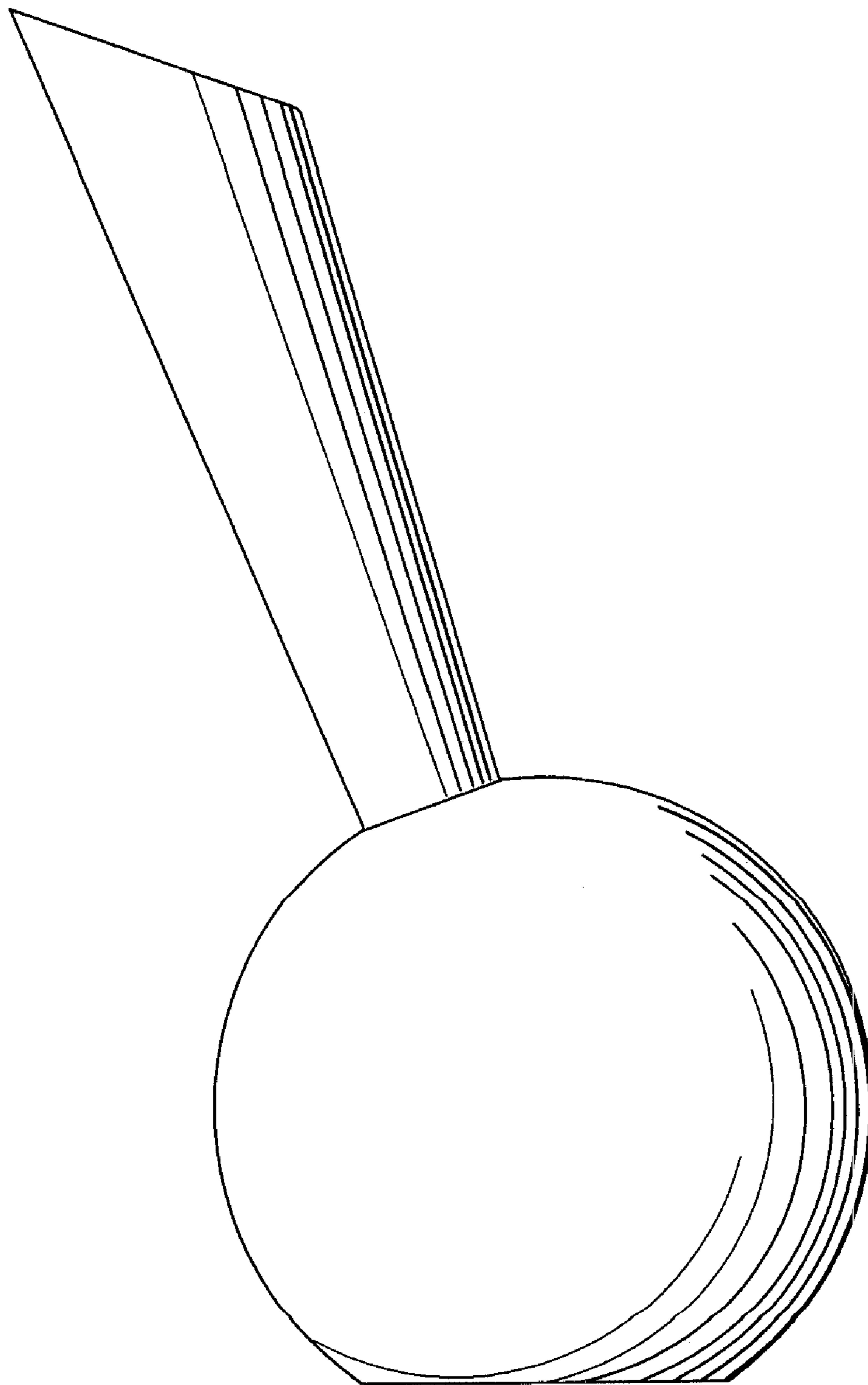

FIG. 5

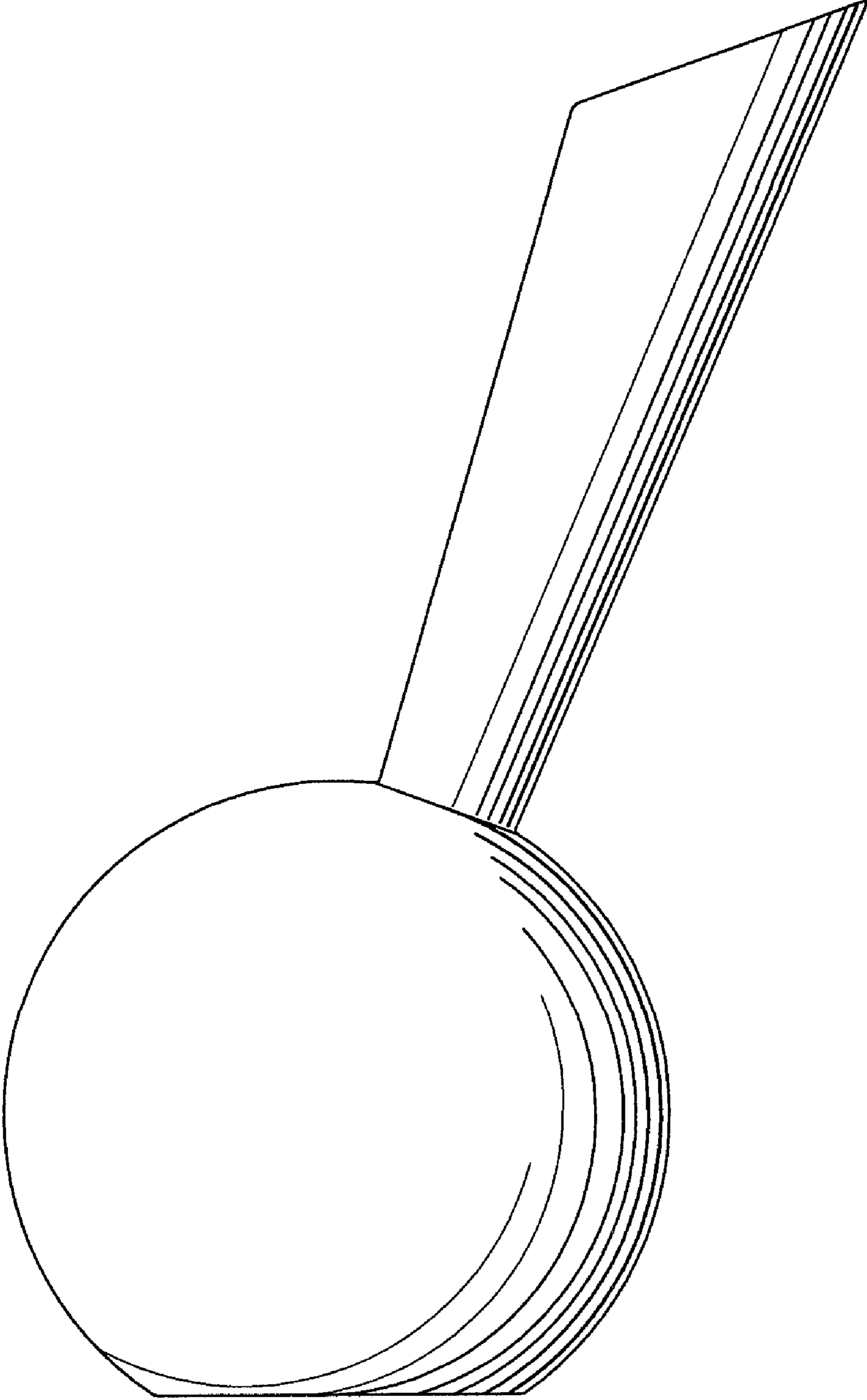

FIG. 6

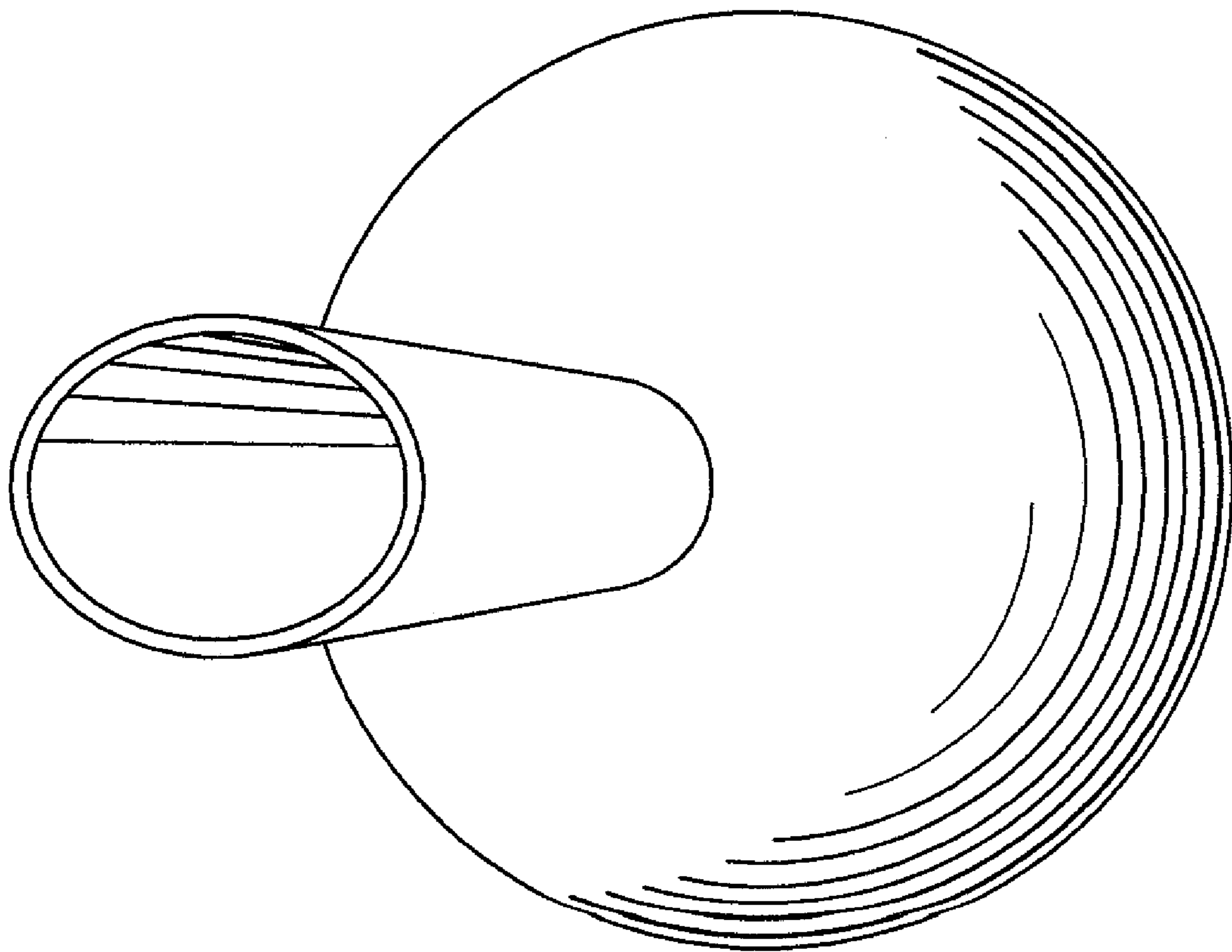

FIG. 7

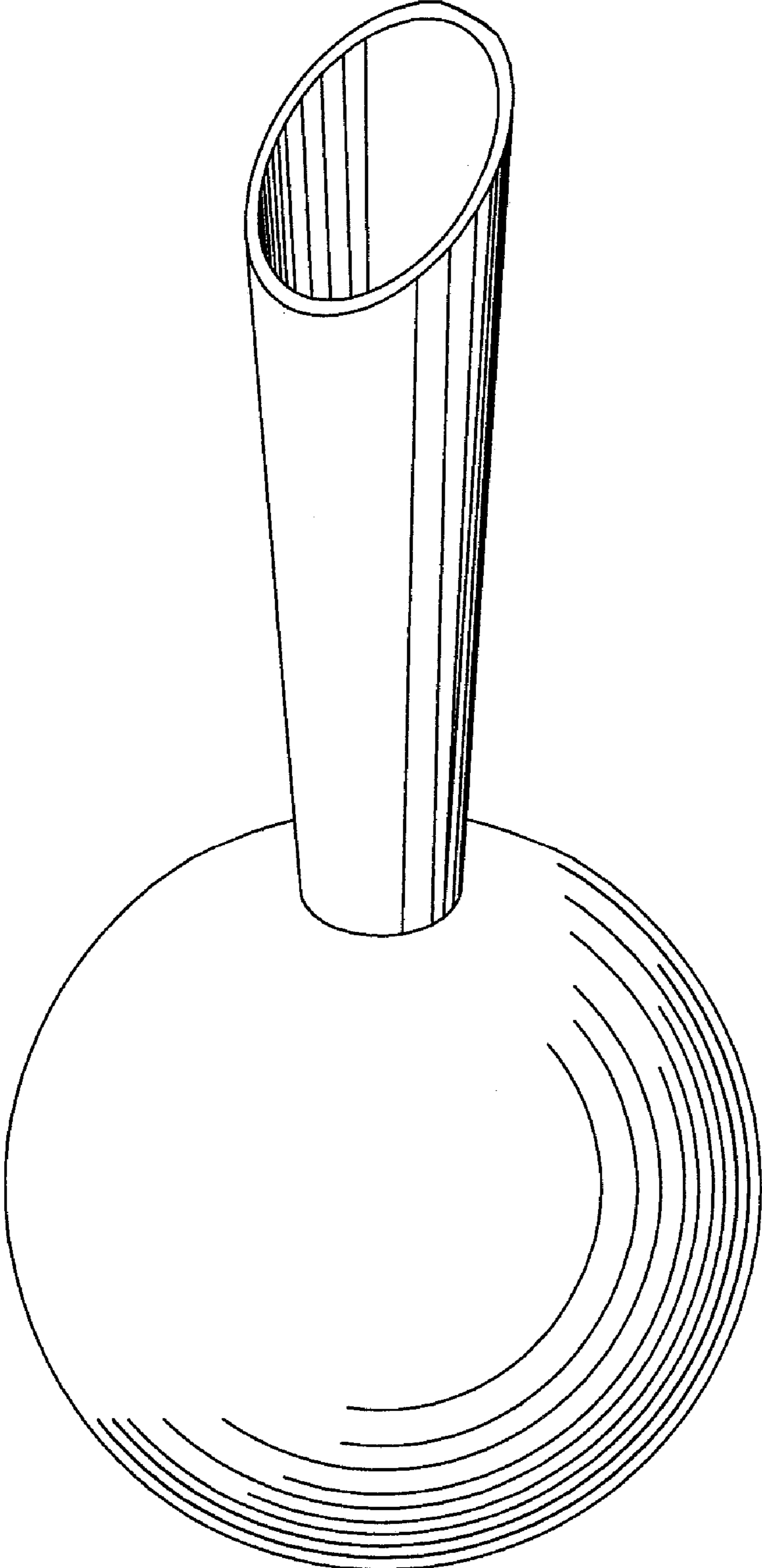

FIG. 8

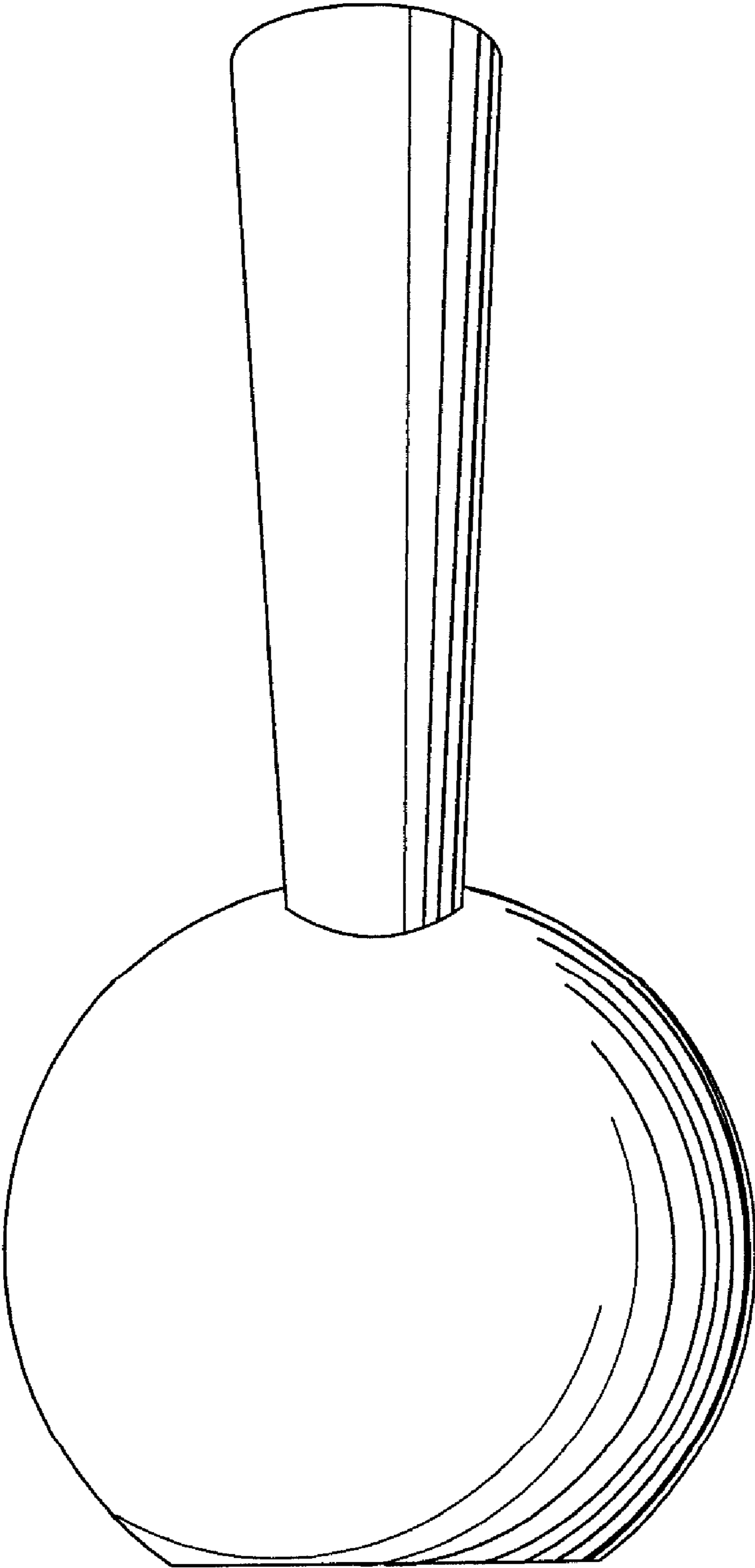

FIG. 9

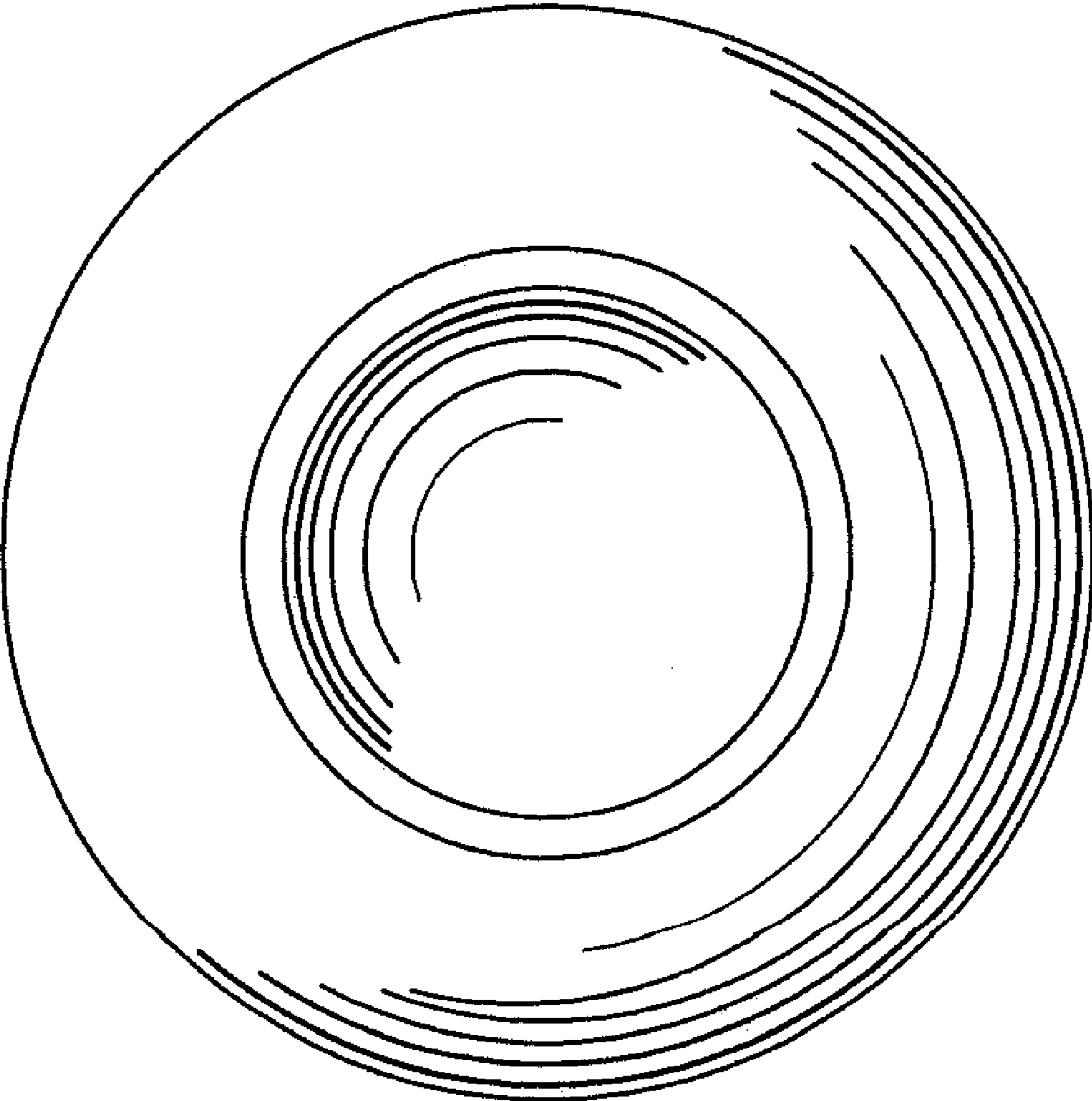

FIG. 10

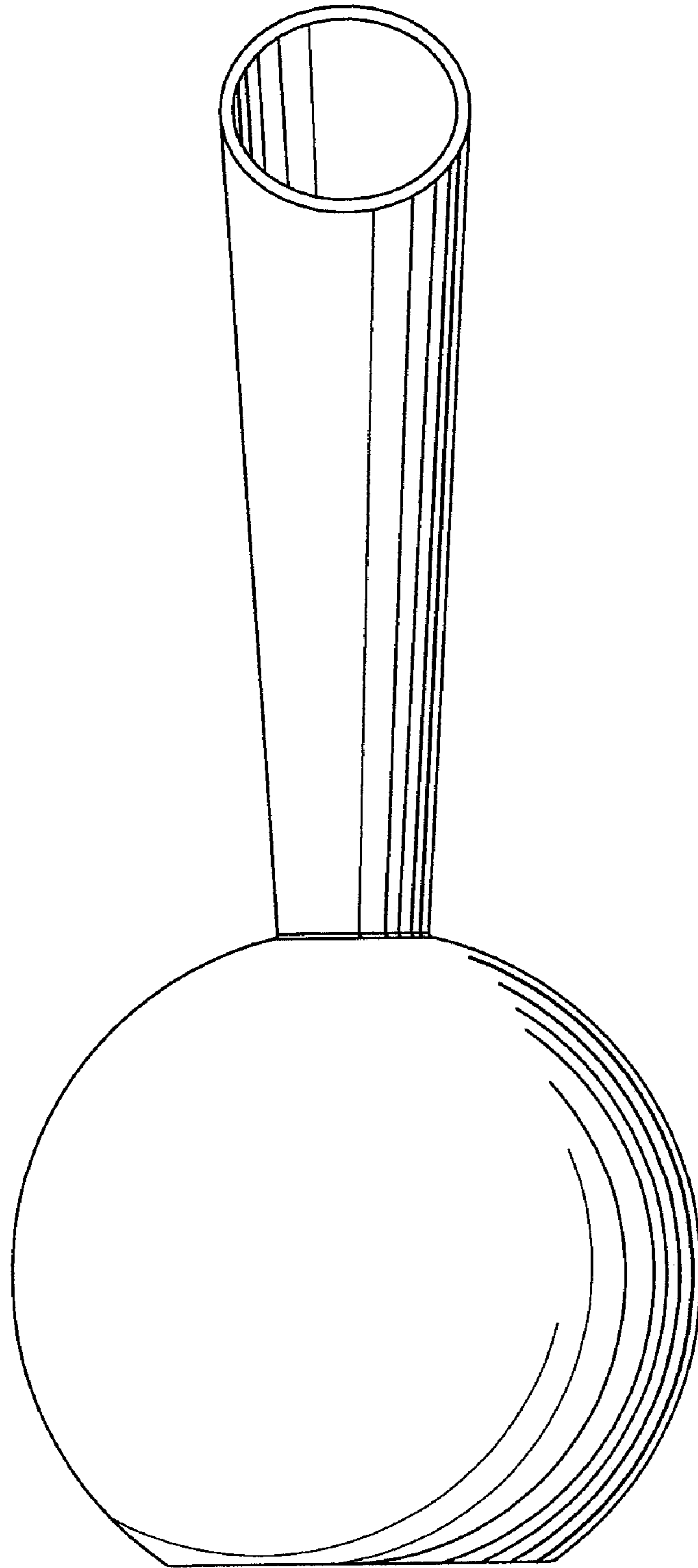

FIG. 11

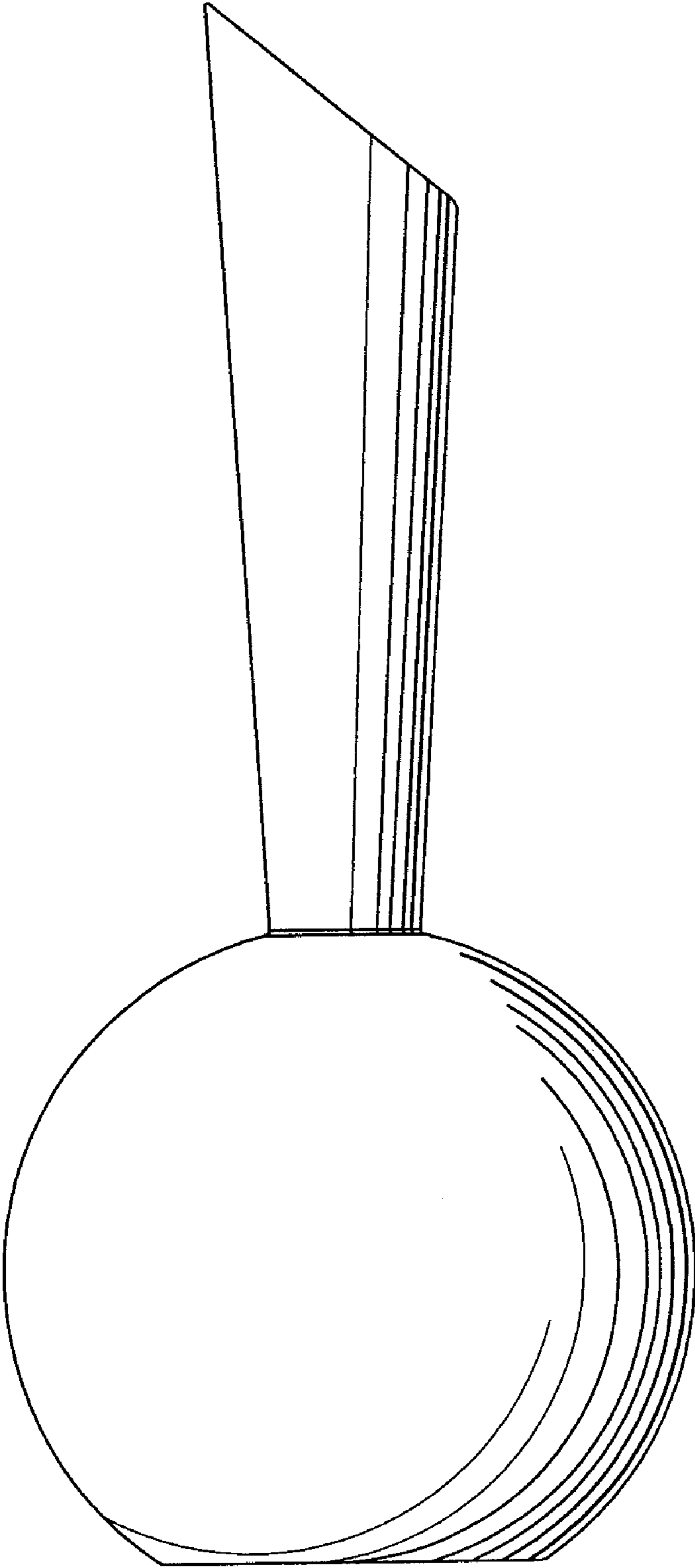

FIG. 12

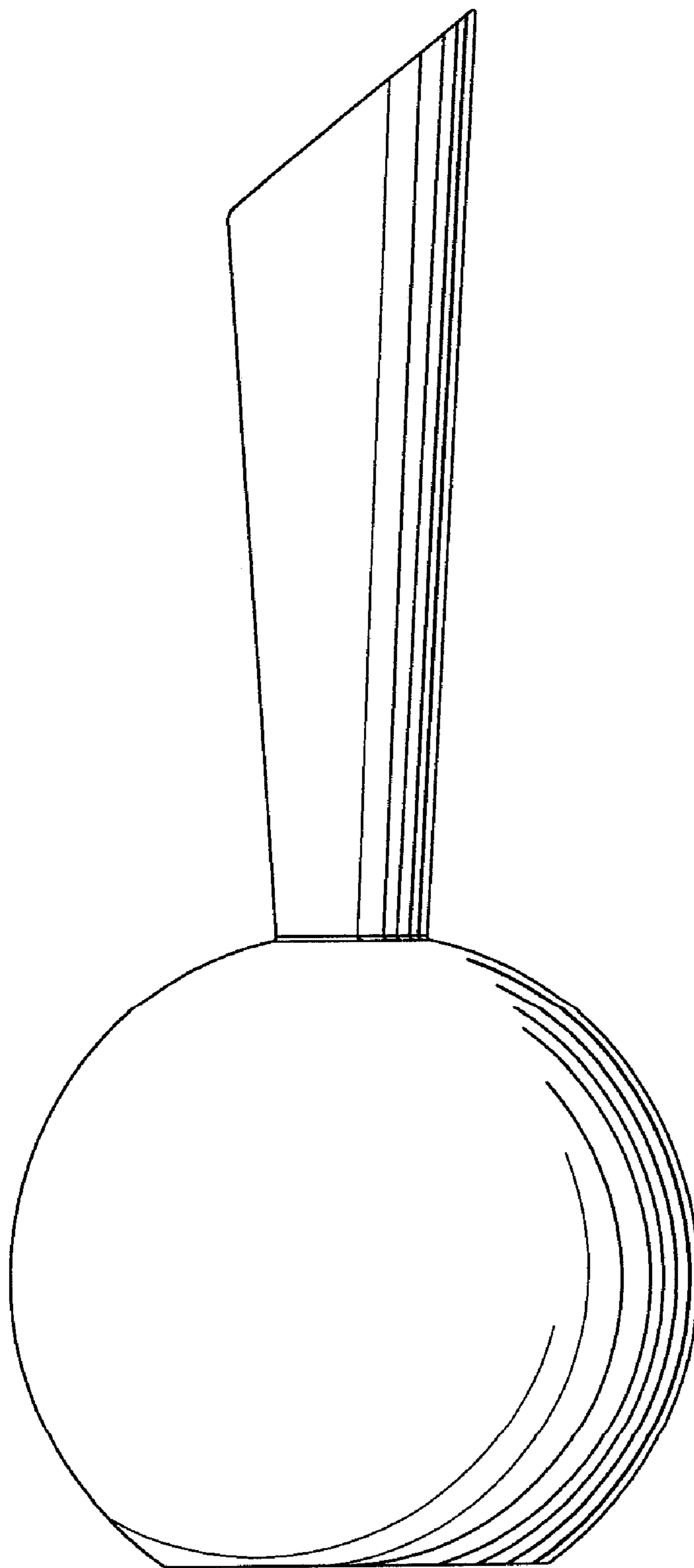

FIG. 13

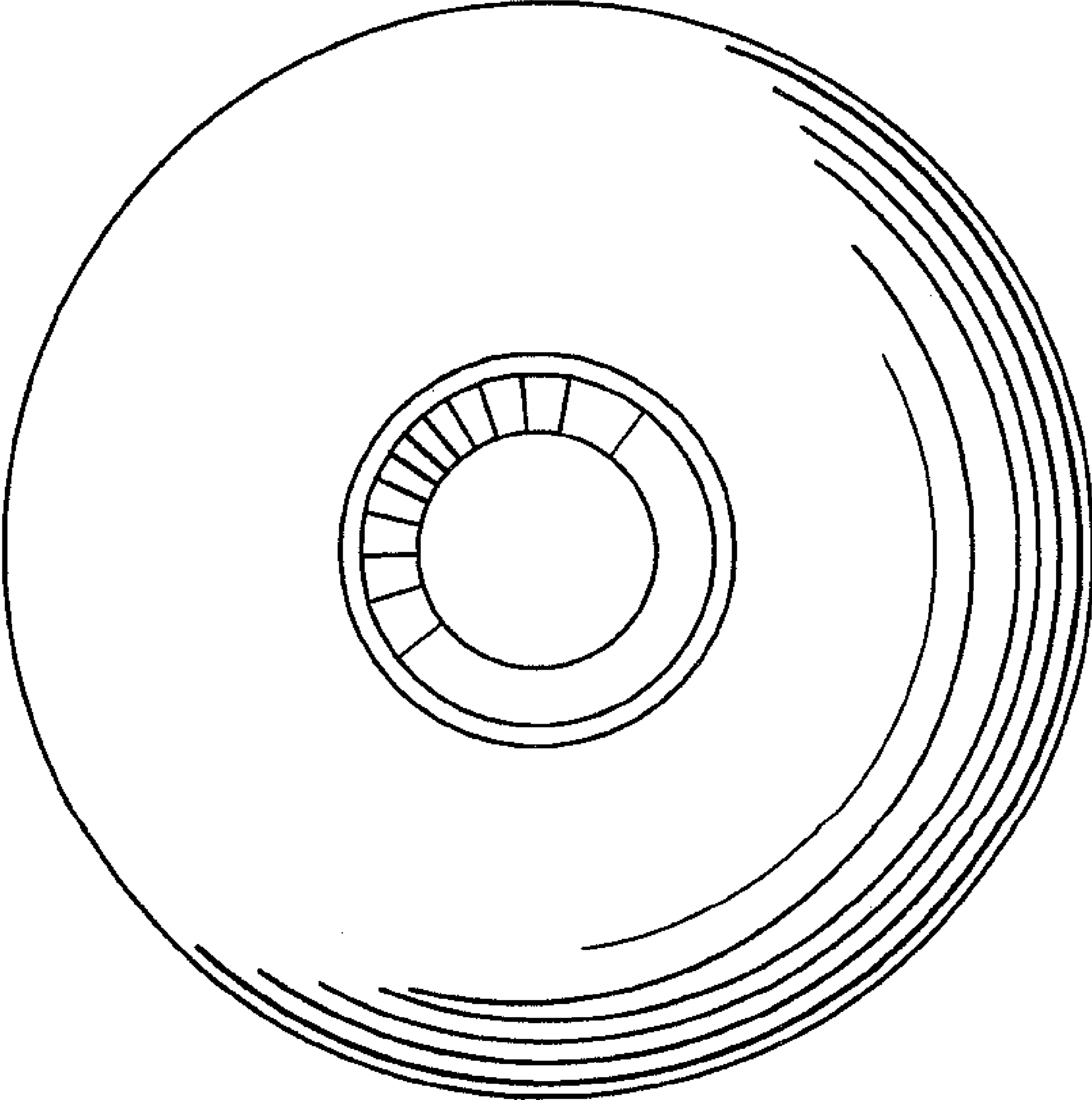

FIG. 14