



US00D579233S

(12) **United States Design Patent**
LeTourneau

(10) **Patent No.:** **US D579,233 S**
(45) **Date of Patent:** **** Oct. 28, 2008**

- (54) **VANITY**
- (75) Inventor: **Alexander V. LeTourneau**, Sheboygan, WI (US)
- (73) Assignee: **Kohler Co.**, Kohler, WI (US)
- (**) Term: **14 Years**
- (21) Appl. No.: **29/279,765**
- (22) Filed: **May 7, 2007**
- (51) **LOC (8) Cl.** **06-04**
- (52) **U.S. Cl.** **D6/446**
- (58) **Field of Classification Search** D6/397,
D6/425-426, 429, 432-448, 470, 474, 477-480,
D6/484, 492, 561; D23/286, 308; 4/643;
62/256; 248/188.4; 312/108, 114, 117, 204,
312/244, 227, 237, 297, 330.1, 334.36, 348.3
See application file for complete search history.

(56) **References Cited**

U.S. PATENT DOCUMENTS

D168,443 S * 12/1952 Gershun D6/446

(Continued)

OTHER PUBLICATIONS

Kallista. "Barbara Barry Vanity". Model No. P73010-00. Kallista online catalog. Copyright 2007 Kallista.

(Continued)

Primary Examiner—Caron D. Veynar
Assistant Examiner—Ricky Pham
(74) *Attorney, Agent, or Firm*—Quarles & Brady LLP

(57) **CLAIM**

The ornamental design for a vanity, as shown and described.

DESCRIPTION

In a preferred embodiment, the nature of this product is a vanity such as can be used to support a lavatory.

FIG. 1 is a right, top, front perspective view of a vanity embodying my new design;

- FIG. 2 is a front elevational view thereof;
 - FIG. 3 is a right side elevational view thereof, the left side elevational view thereof being a mirror image of the right side shown;
 - FIG. 4 is a top plan view thereof;
 - FIG. 5 is a rear elevational view thereof;
 - FIG. 6 is a bottom plan view thereof;
 - FIG. 7 is a right, top, front perspective view of a vanity according to another embodiment of my new design, the right side elevational view thereof being identical to FIG. 3 and the left side elevational view thereof being a mirror image of FIG. 3;
 - FIG. 8 is a front elevational view thereof;
 - FIG. 9 is a top plan view thereof;
 - FIG. 10 is a rear elevational view thereof;
 - FIG. 11 is a bottom plan view thereof;
 - FIG. 12 is a right, top, front perspective view of a vanity according to another embodiment of my new design, the right side elevational view thereof being identical to FIG. 3 and the left side elevational view thereof being a mirror image of FIG. 3;
 - FIG. 13 is a front elevational view thereof;
 - FIG. 14 is a top plan view thereof;
 - FIG. 15 is a rear elevational view thereof;
 - FIG. 16 is a bottom plan view thereof;
 - FIG. 17 is a right, top, front perspective view of a vanity according to another embodiment of my new design, the right side elevational view thereof being identical to FIG. 3 and the left side elevational view thereof being a mirror image of FIG. 3;
 - FIG. 18 is a front elevational view thereof;
 - FIG. 19 is a top plan view thereof;
 - FIG. 20 is a rear elevational view thereof; and,
 - FIG. 21 is a bottom plan view thereof.
- The broken line representations in the figures for the purpose of illustration only, and form no part of the claimed design.

1 Claim, 8 Drawing Sheets

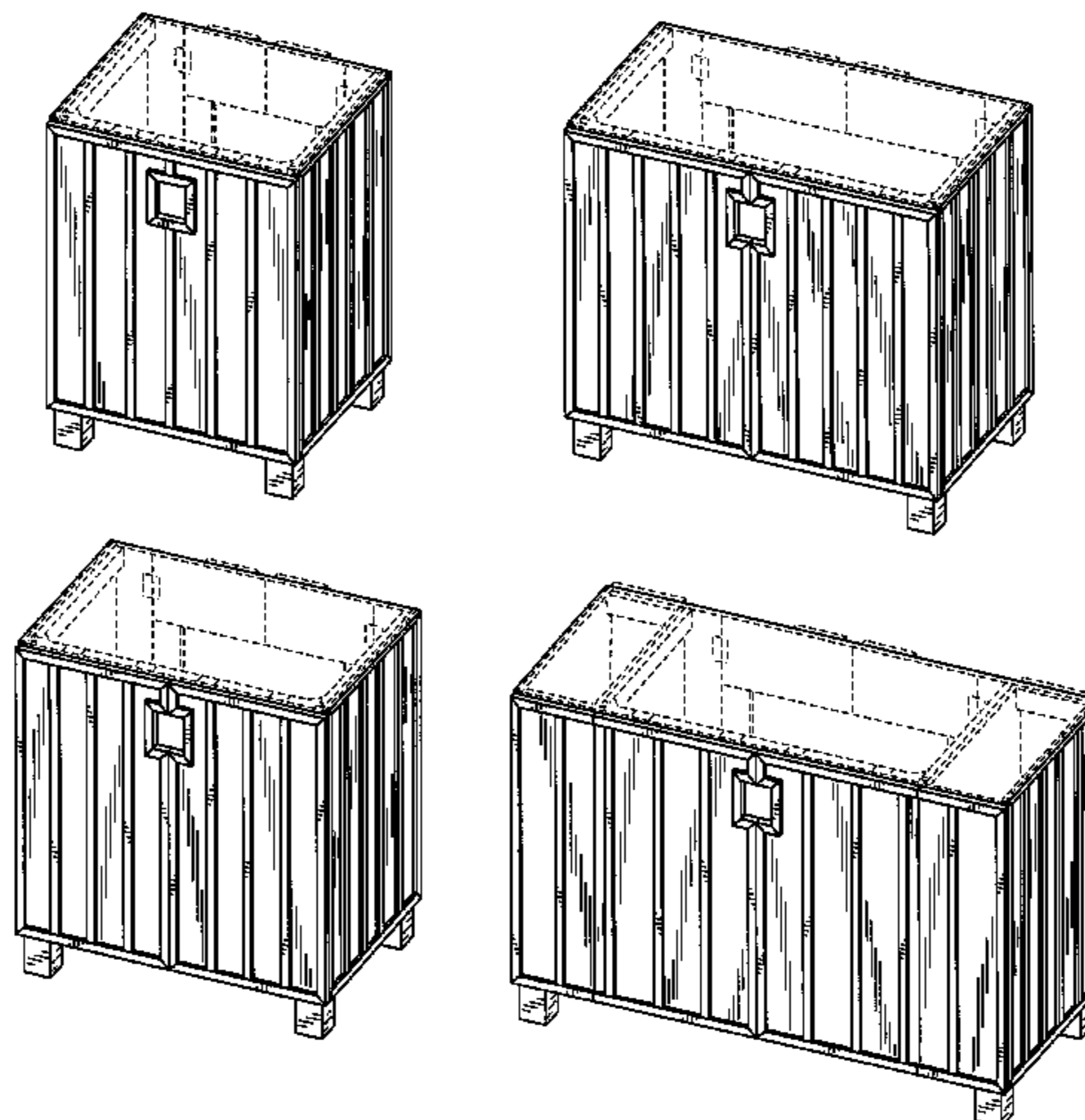

U.S. PATENT DOCUMENTS

4,235,494 A * 11/1980 Chu et al. 312/297
D301,526 S * 6/1989 Jacobs et al. D6/433
D306,106 S * 2/1990 Bush et al. D6/432
4,962,649 A * 10/1990 Battocletti 62/256
D370,580 S * 6/1996 Keller et al. D6/492
D439,095 S * 3/2001 Harwanko D6/561
6,574,805 B1 * 6/2003 Liu 4/643
D534,998 S * 1/2007 Charnik D23/286
D536,770 S * 2/2007 Mayer D23/286
D560,393 S * 1/2008 Svendsen et al. D6/446
D562,586 S * 2/2008 Parker D6/433
2006/0091269 A1 * 5/2006 Hanson 248/188.4

OTHER PUBLICATIONS

Lacava. "Oceanica Vanity". HomePortfolio.com online catalog. Copyright 1997-2007 HomePortfolio.com.
Villeroy & Boch Bath & Kitchen. "Epura Cottage Basin and Vanity". HomePortfolio.com online catalog. Copyright 1997-2007 HomePortfolio.com.
Empire. "Empire 48 Inch Dark Malibu 100 Collection bathroom vanity". Empire.com online catalog. Copyright 1997-2007 Mercantila, Inc.

* cited by examiner

FIG. 1

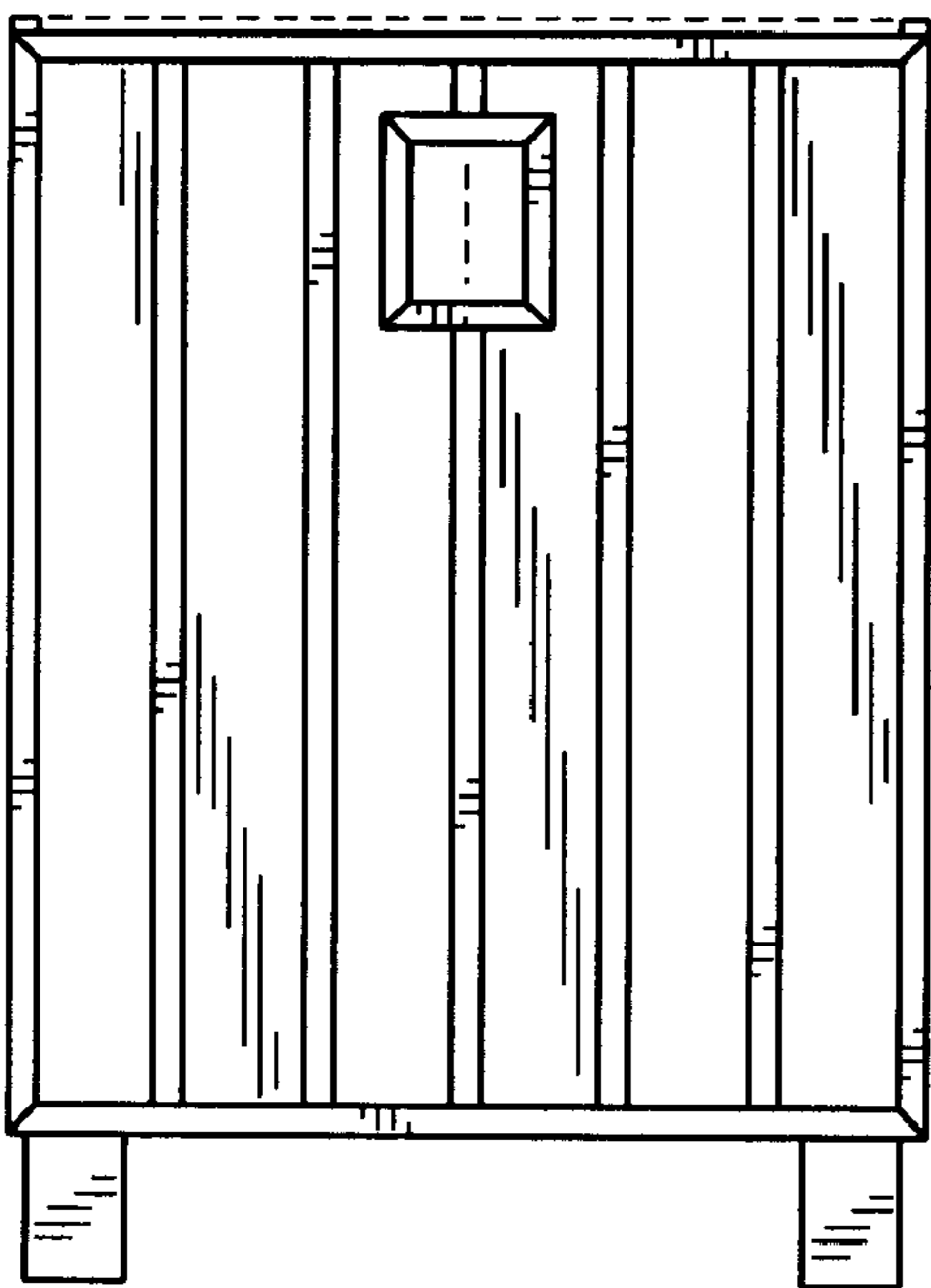
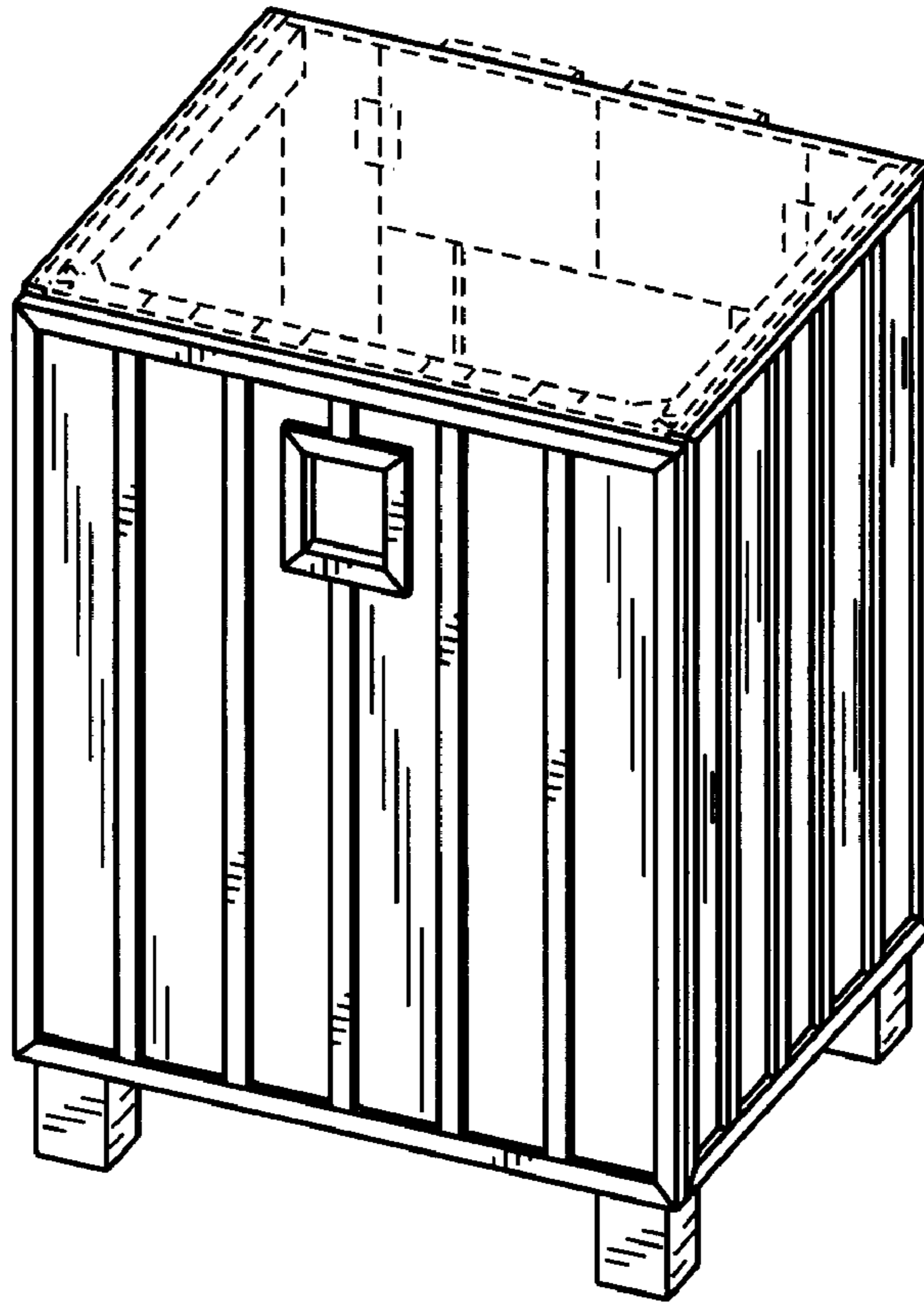

FIG. 2

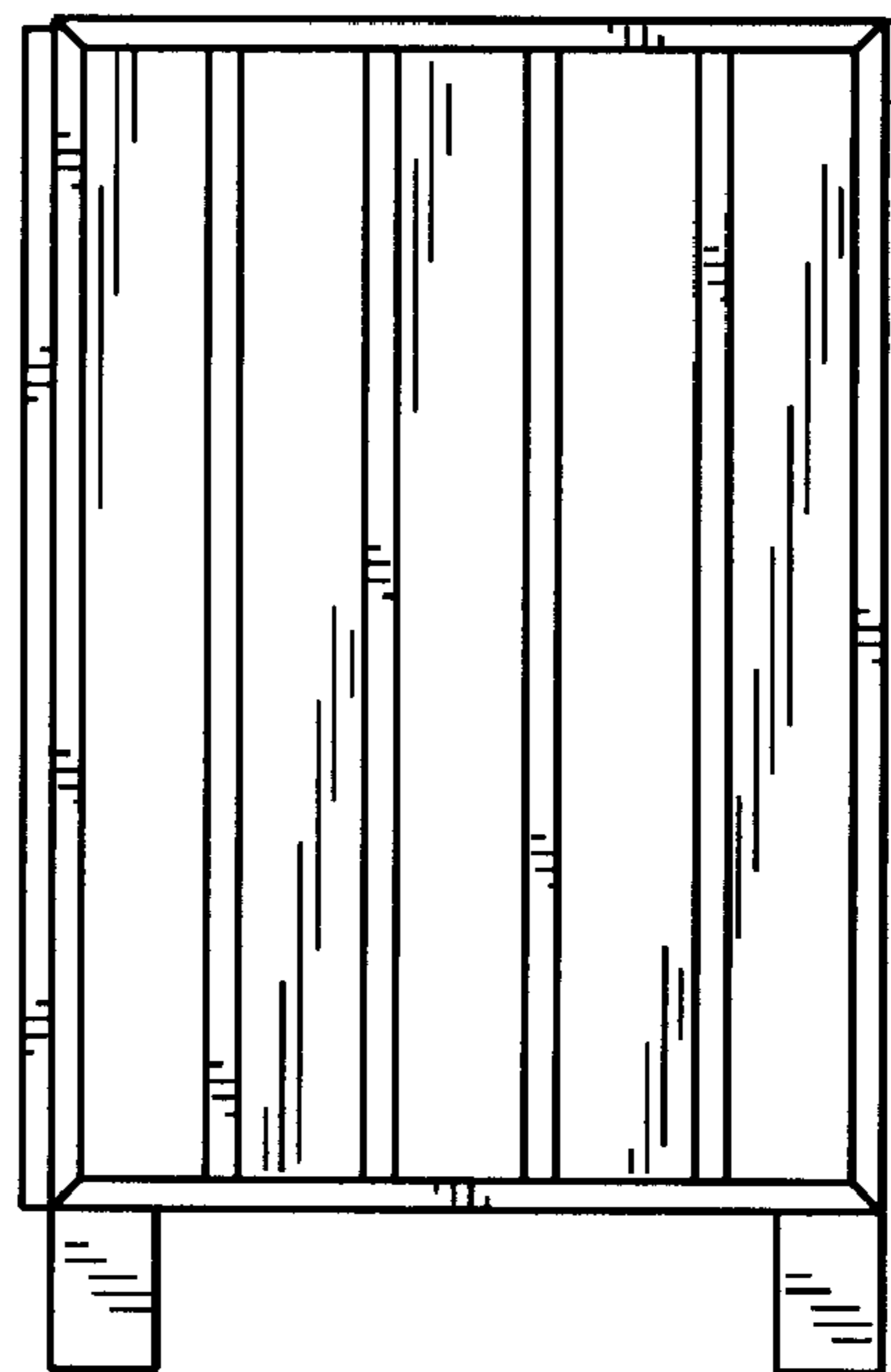

FIG. 3

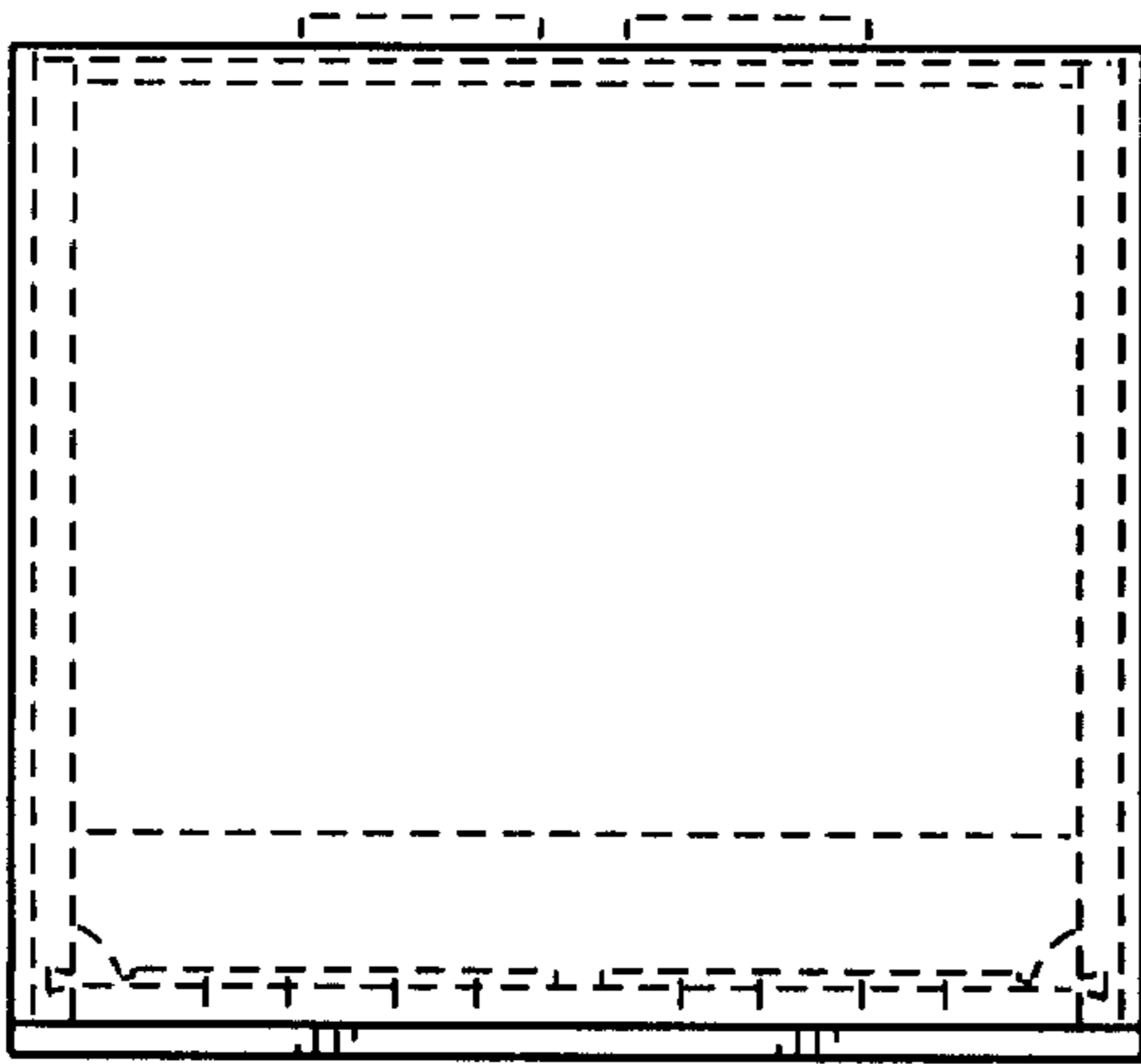

FIG. 4

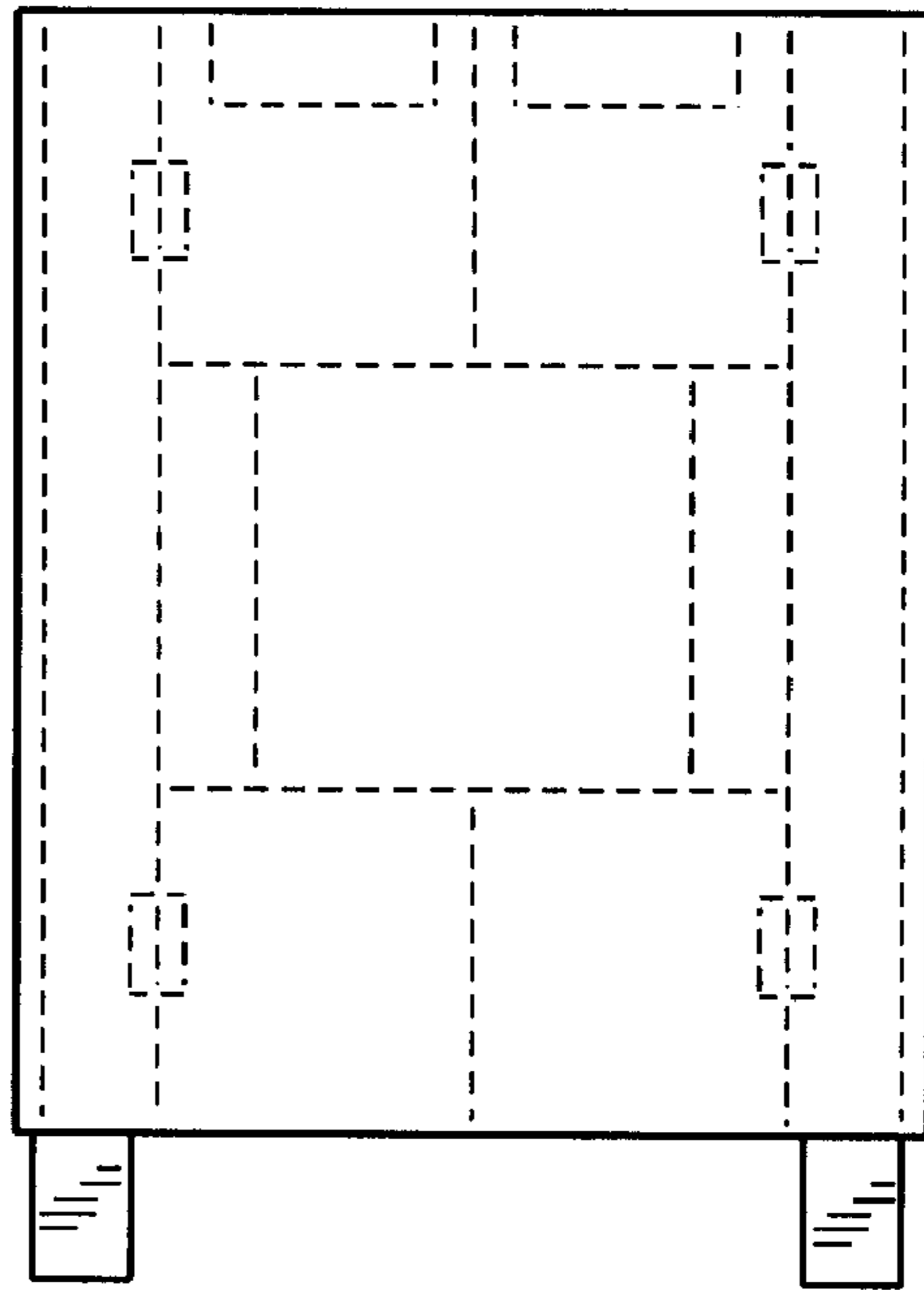

FIG. 5

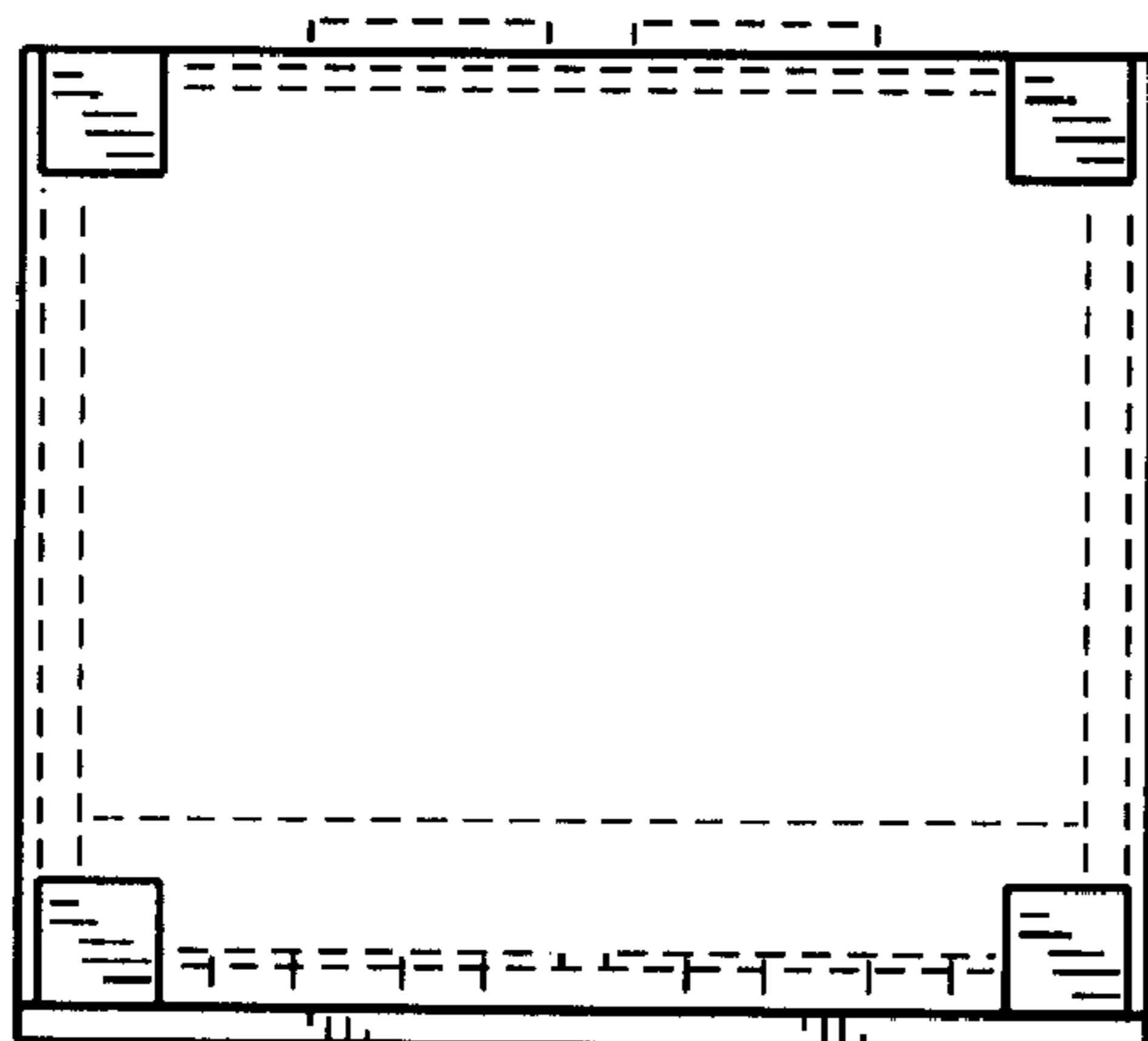

FIG. 6

FIG. 7

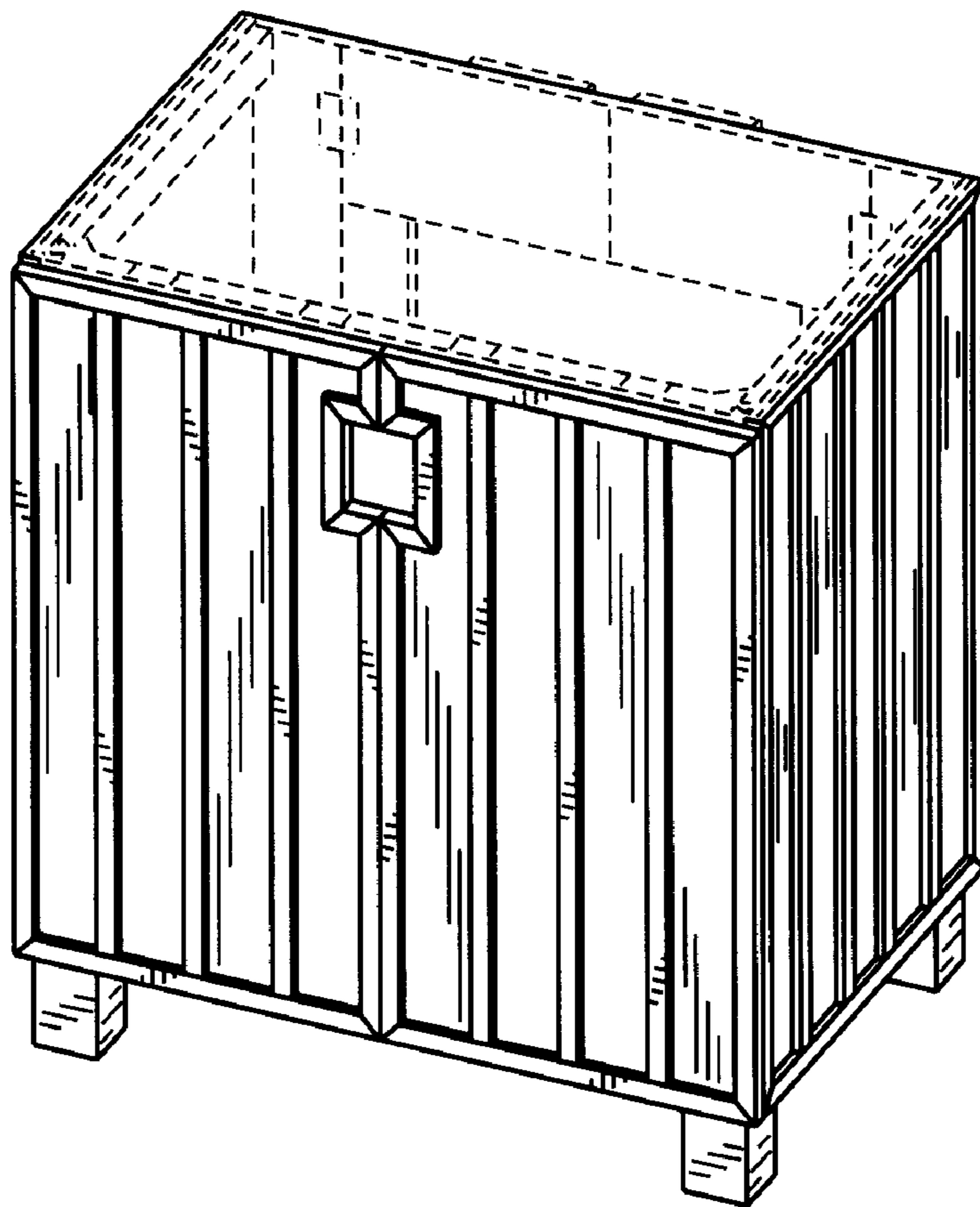
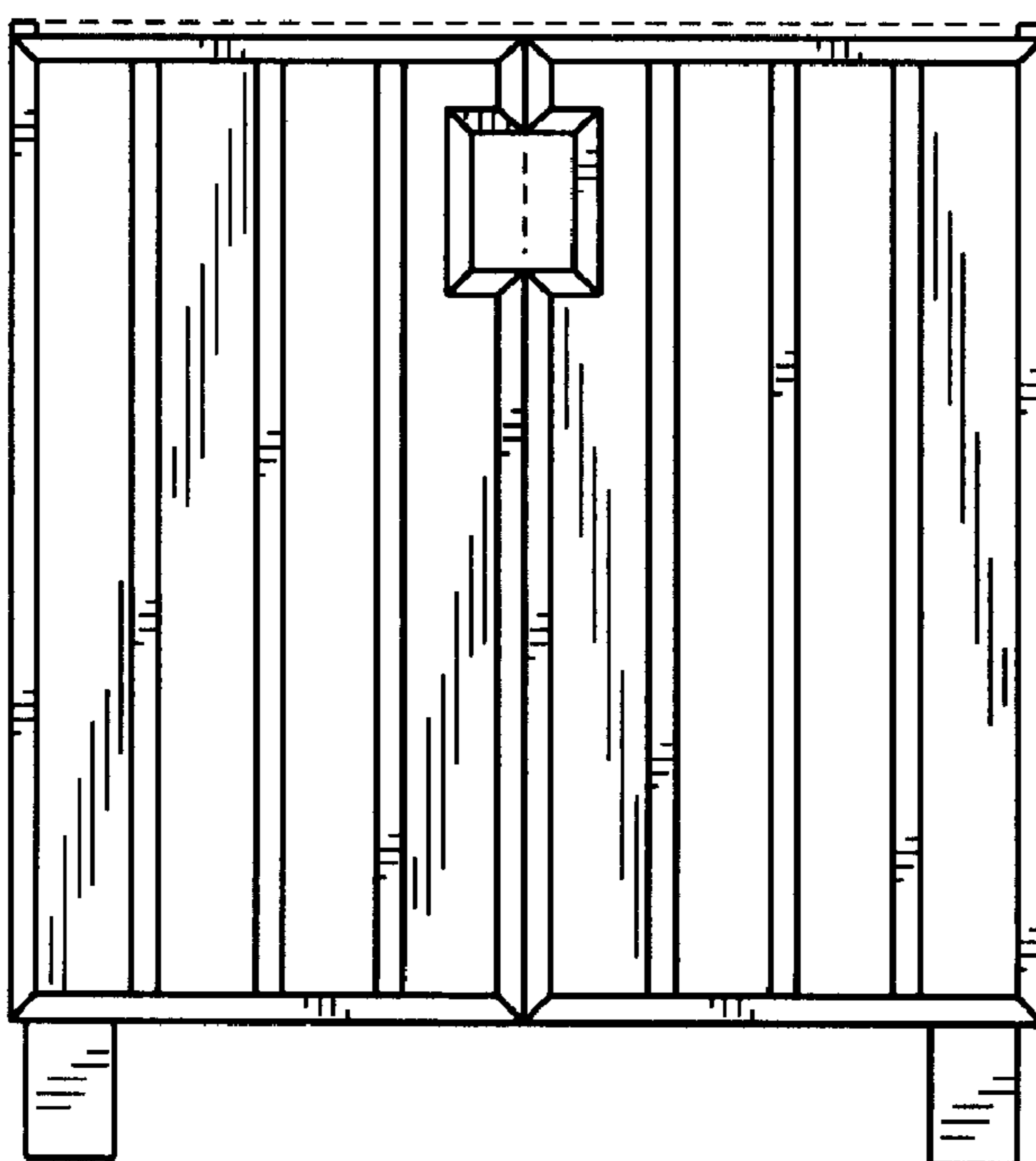

FIG. 8



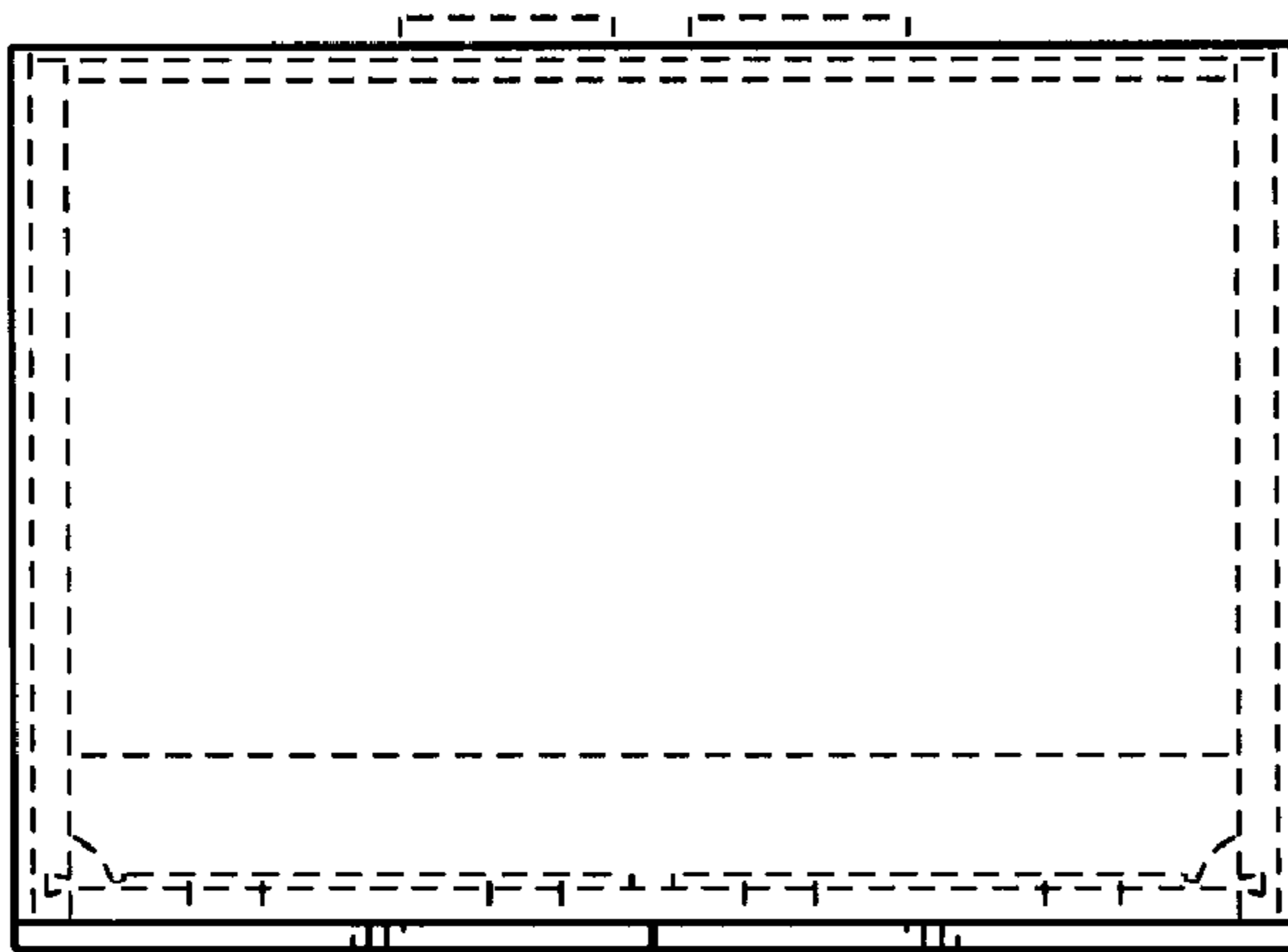

FIG. 9

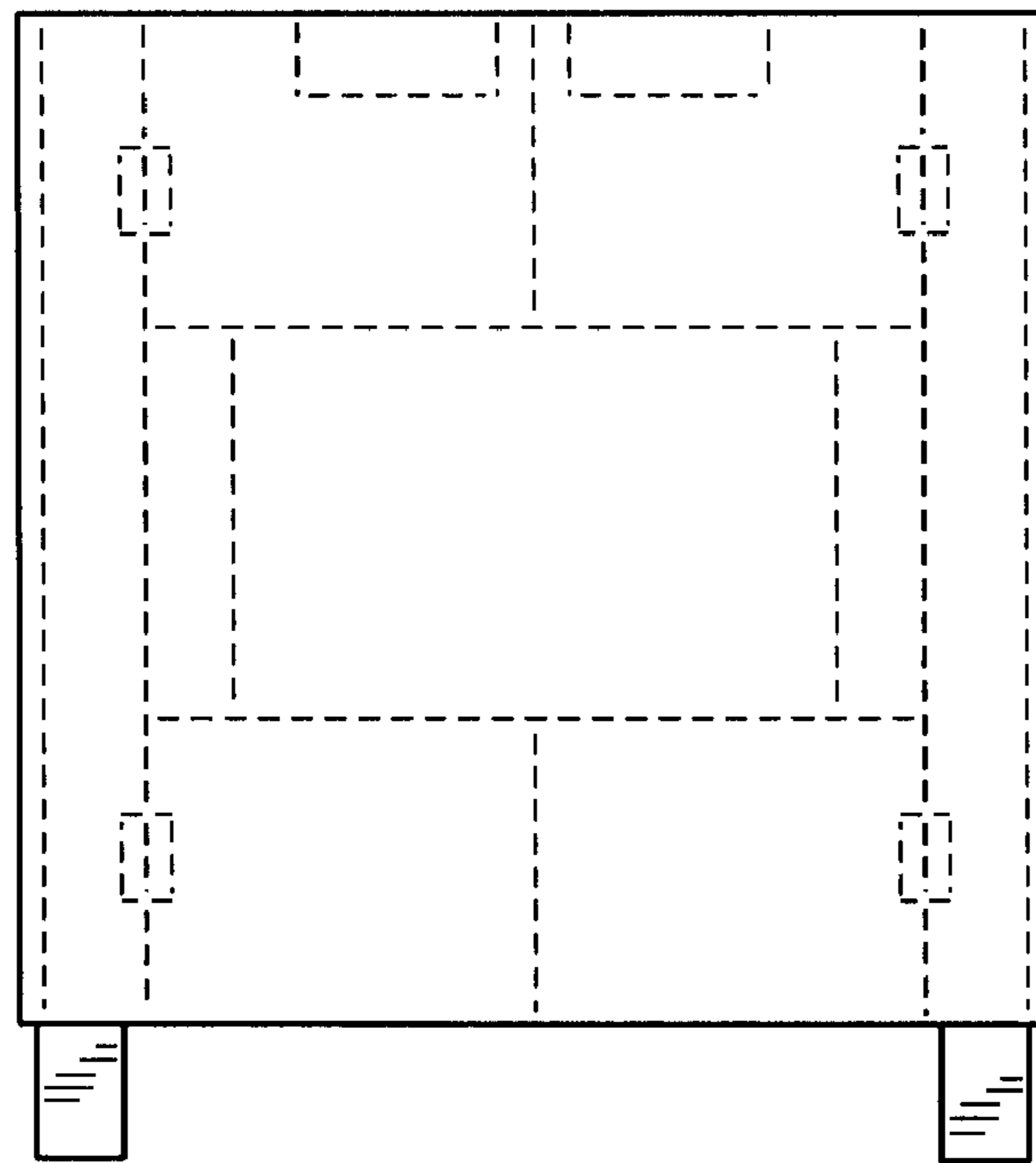

FIG. 10

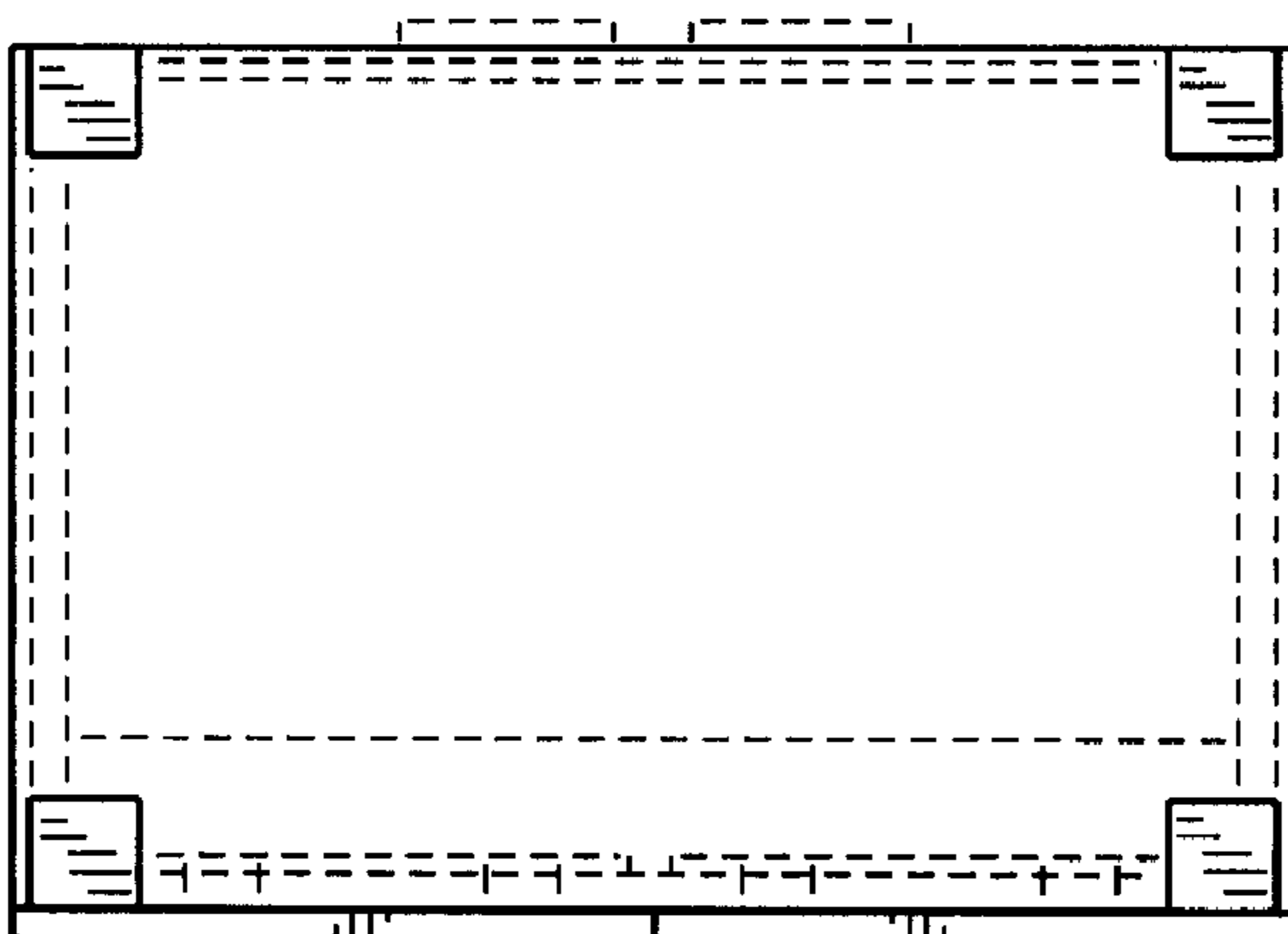

FIG. 11

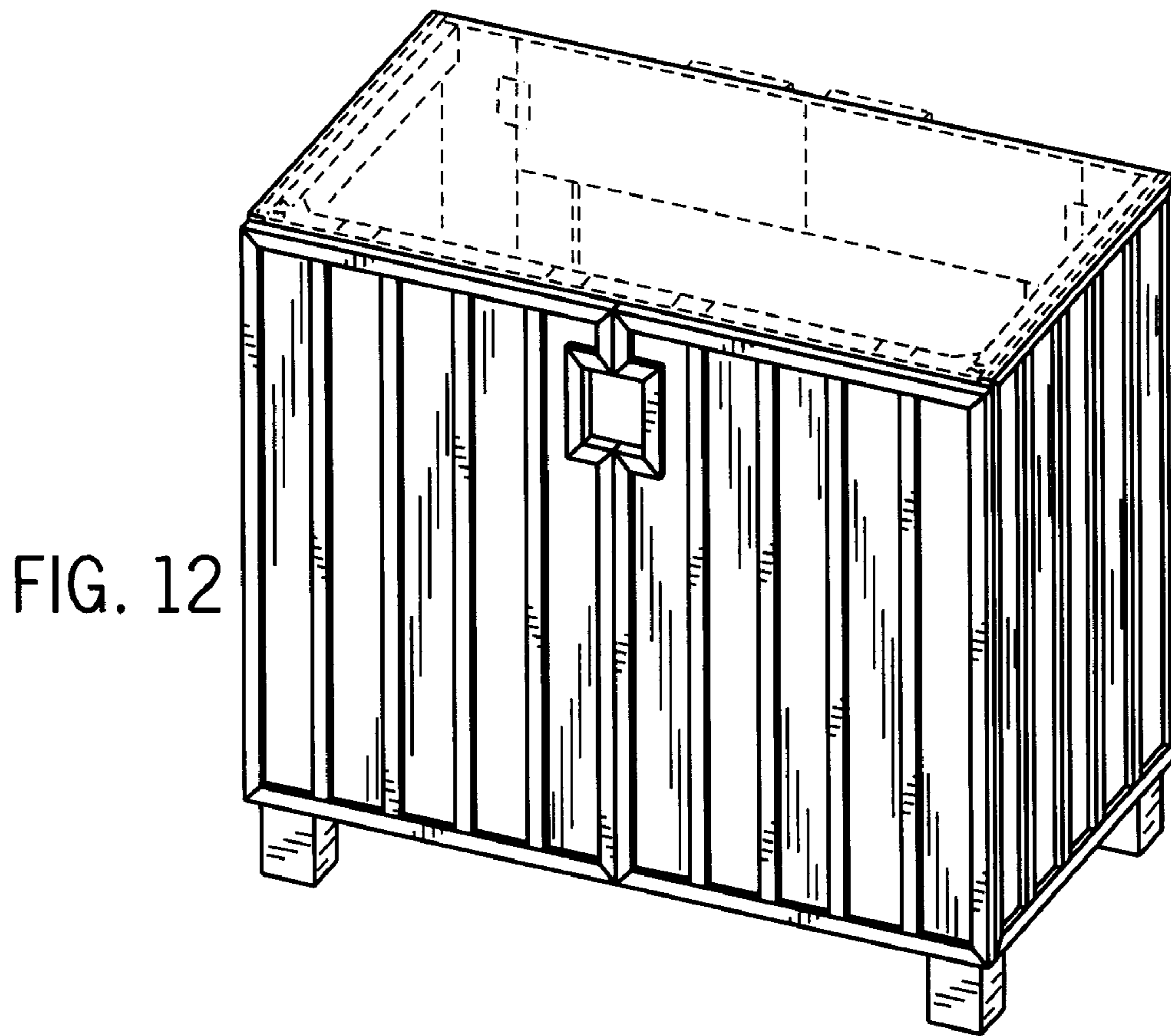

FIG. 12

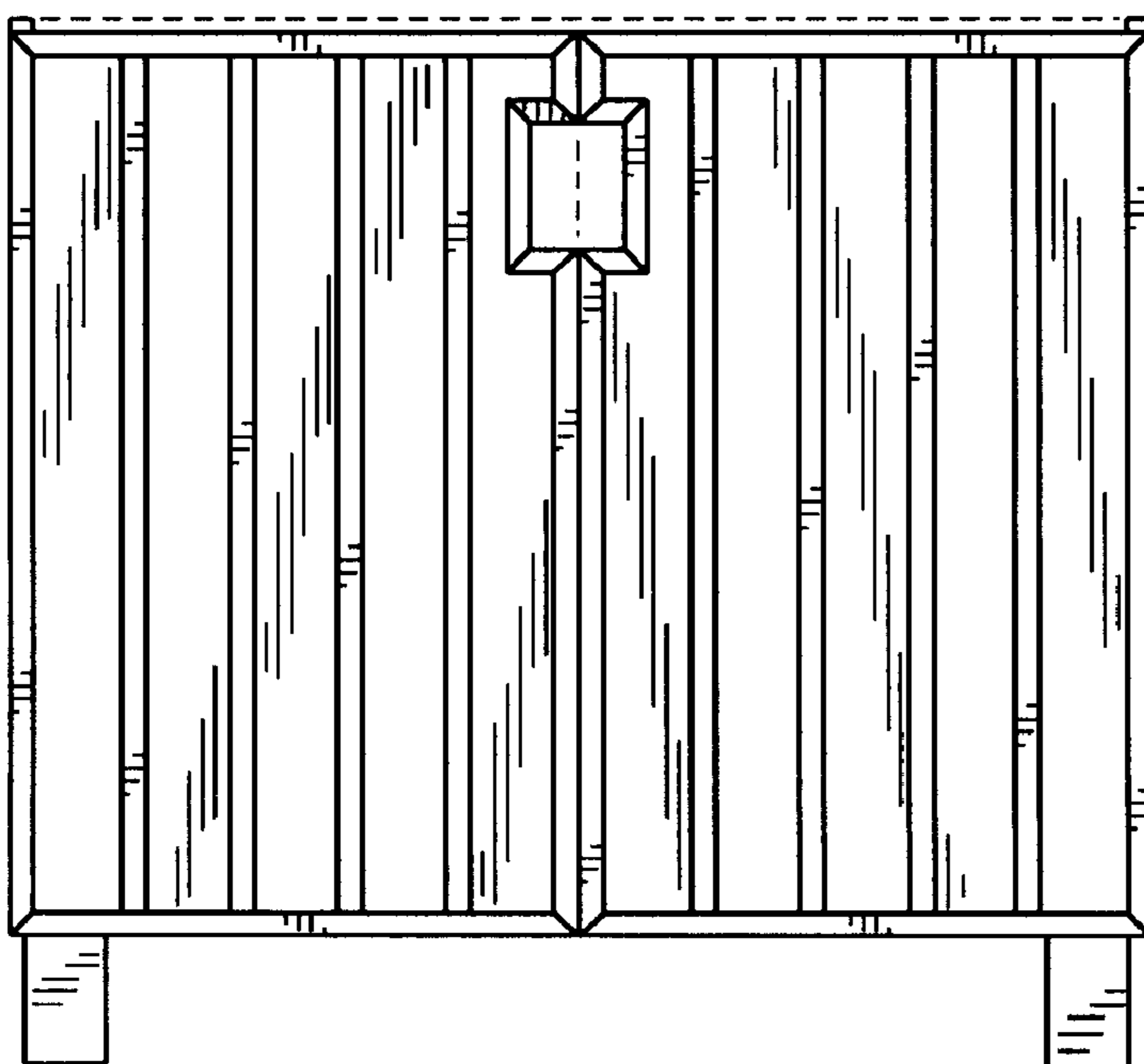

FIG. 13

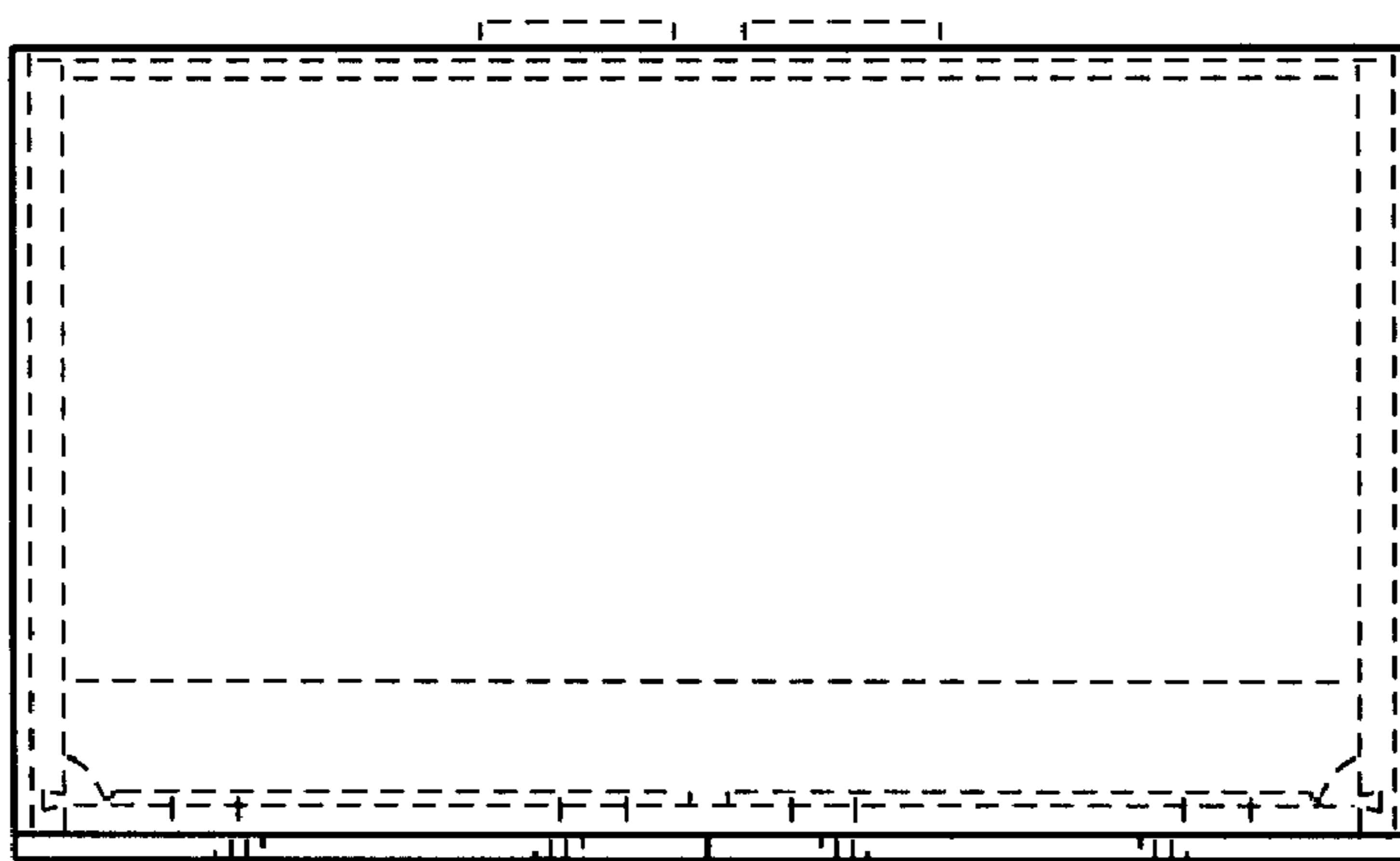

FIG. 14

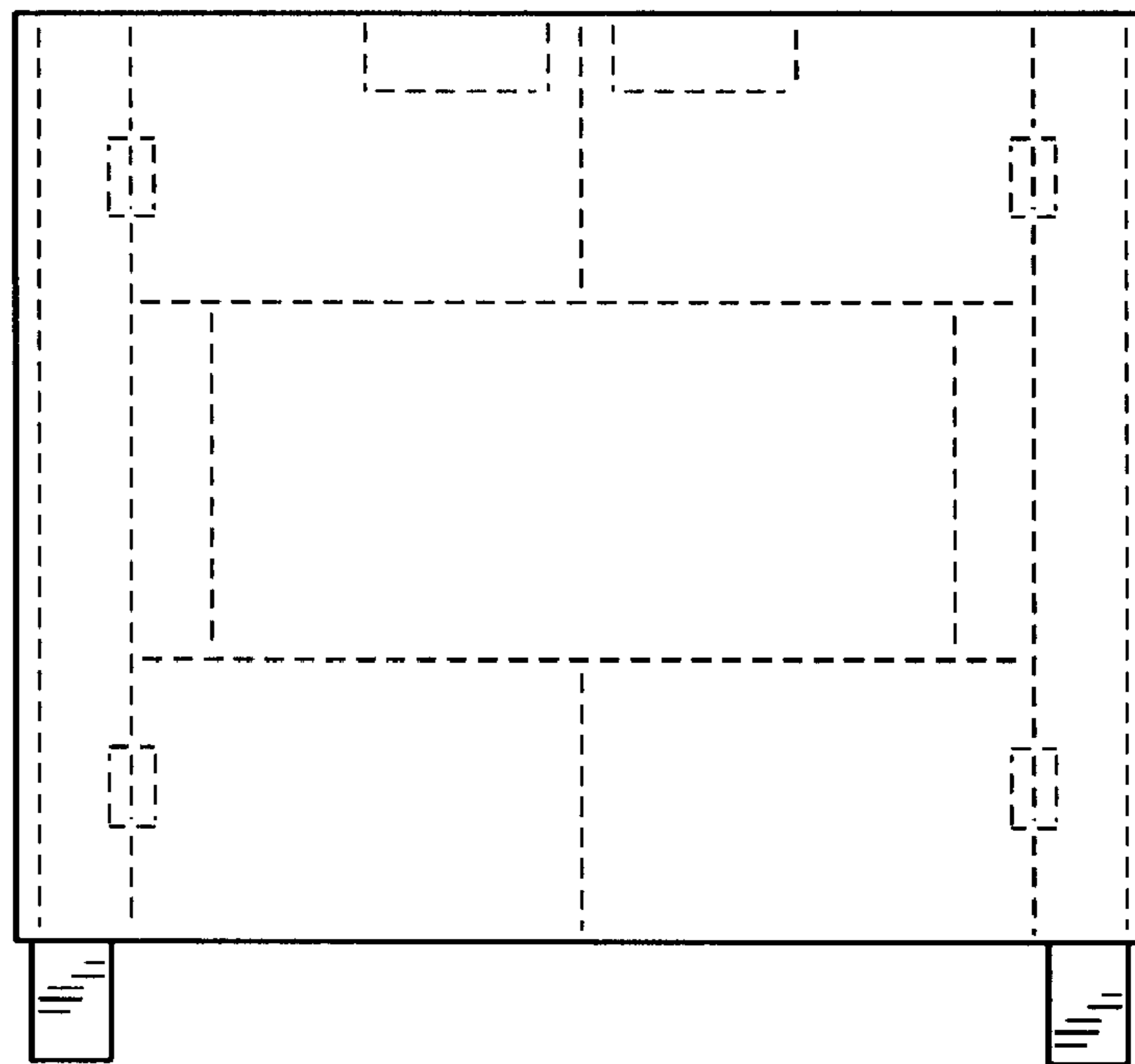

FIG. 15

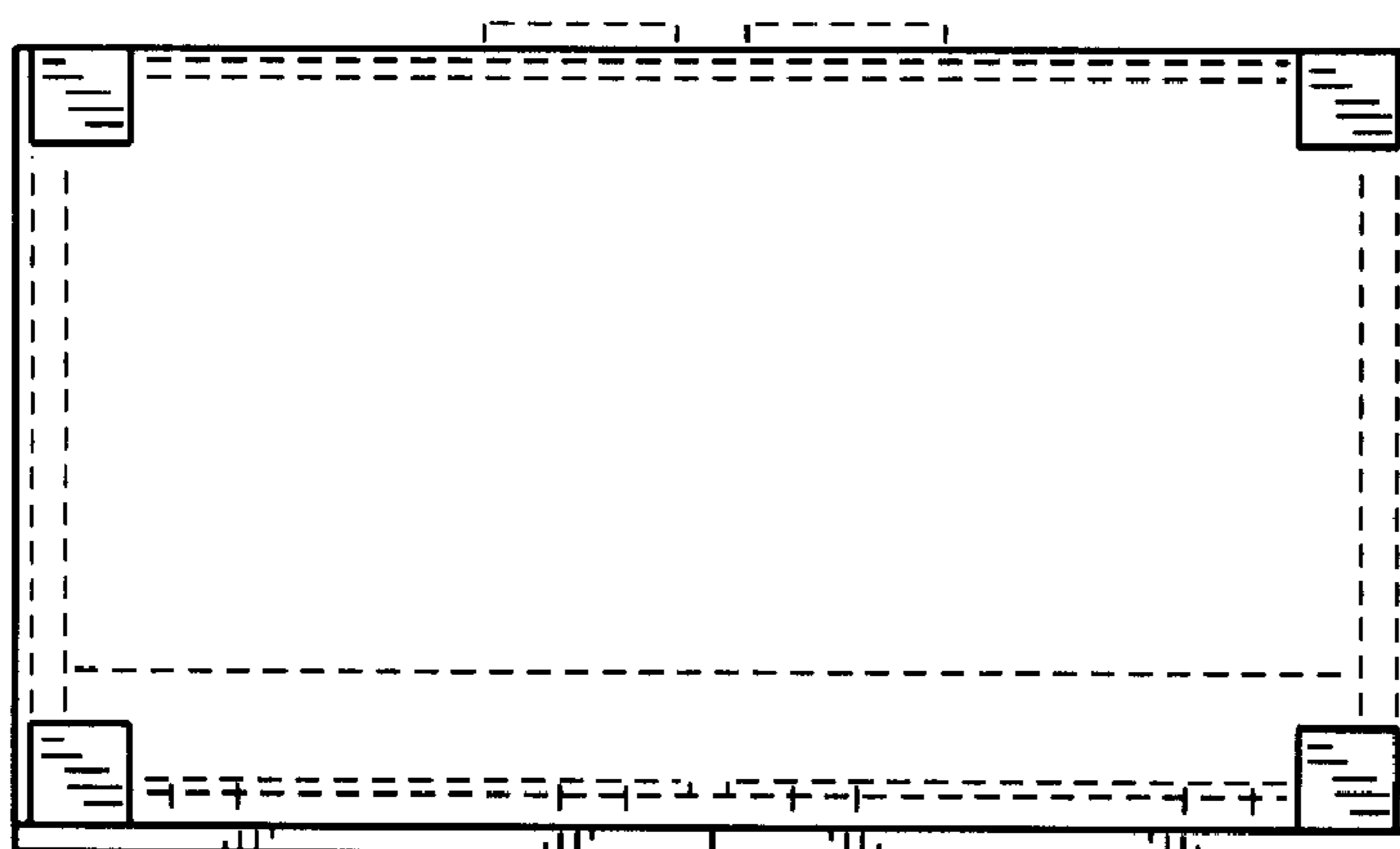

FIG. 16

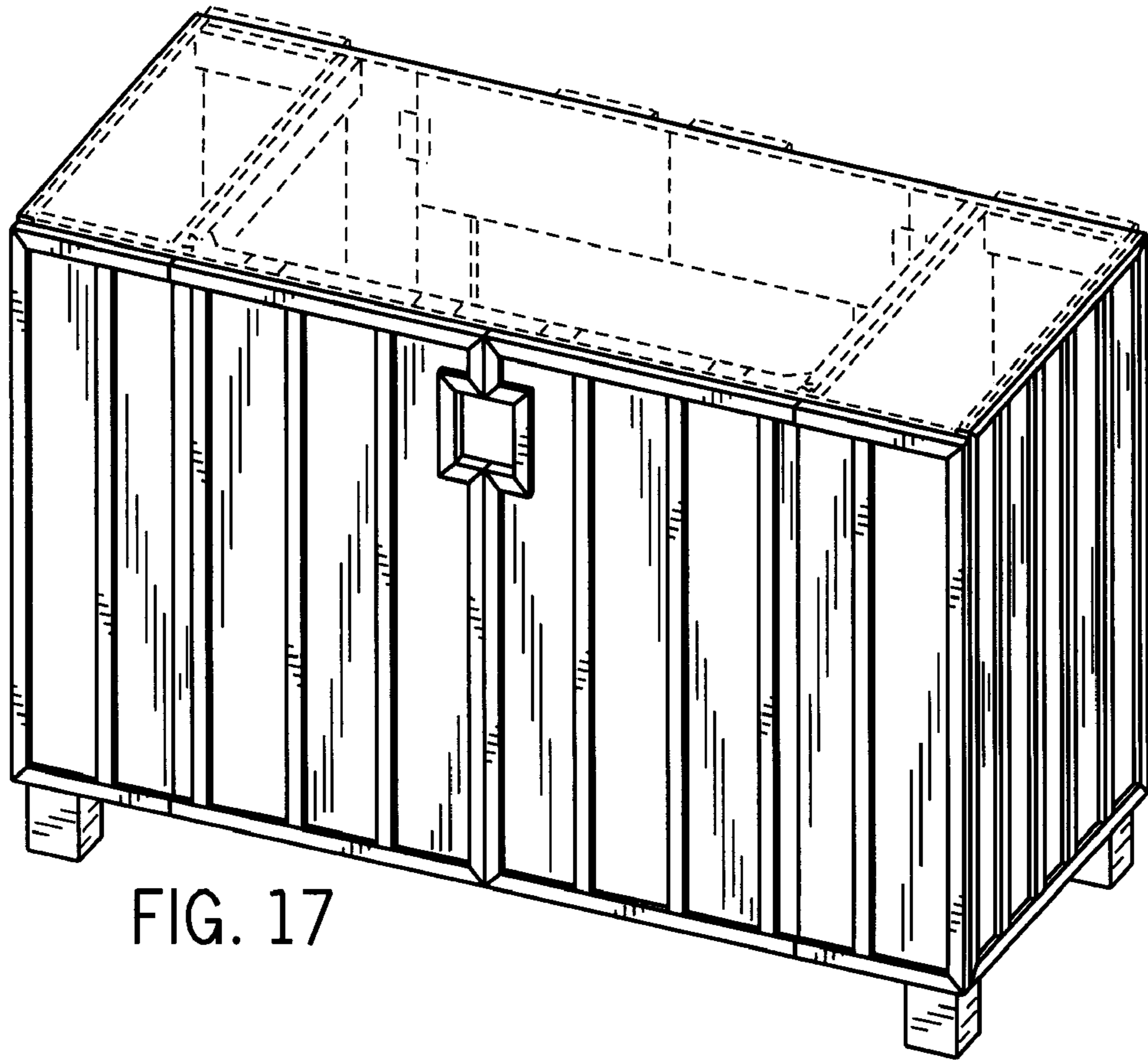

FIG. 17

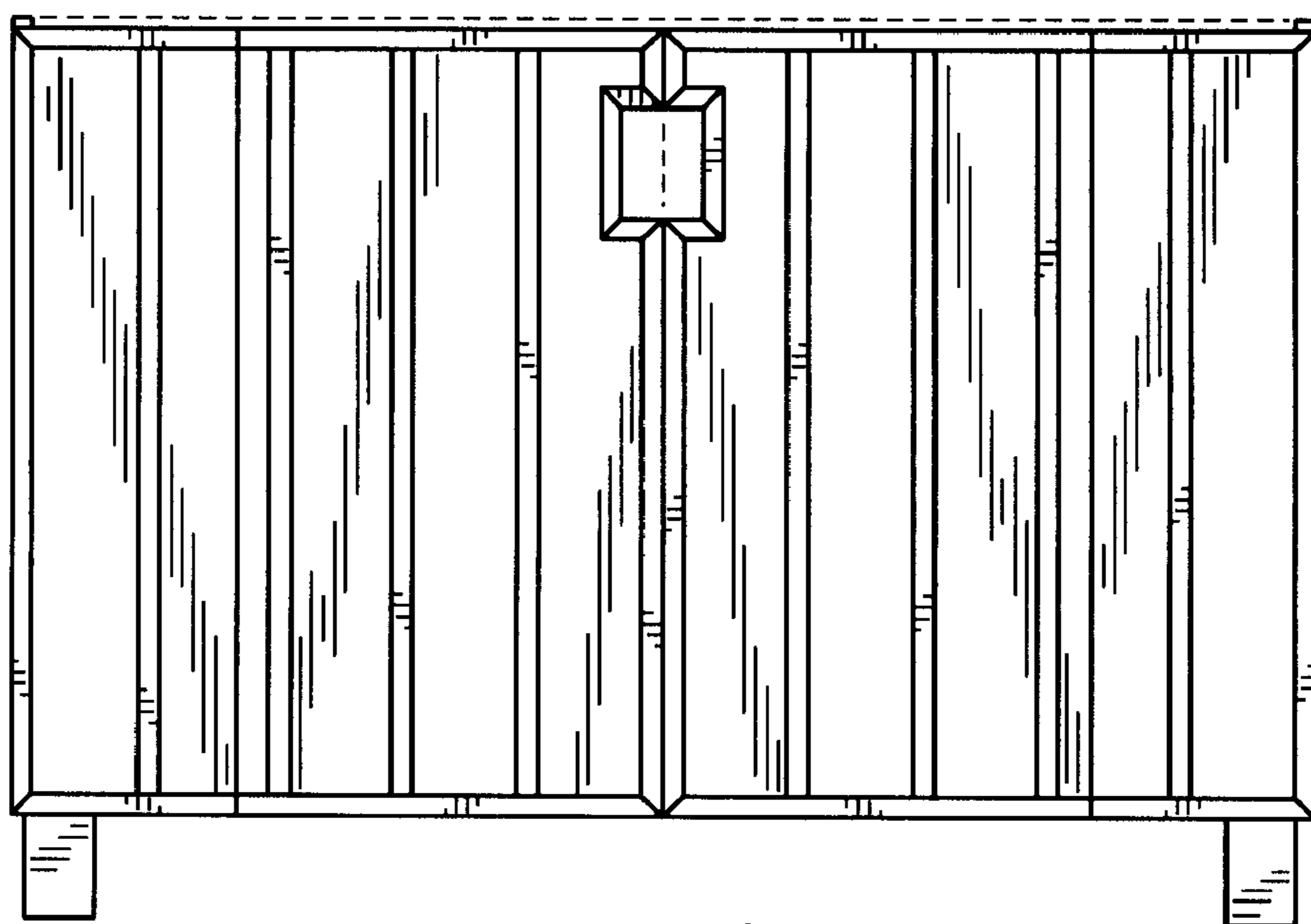

FIG. 18

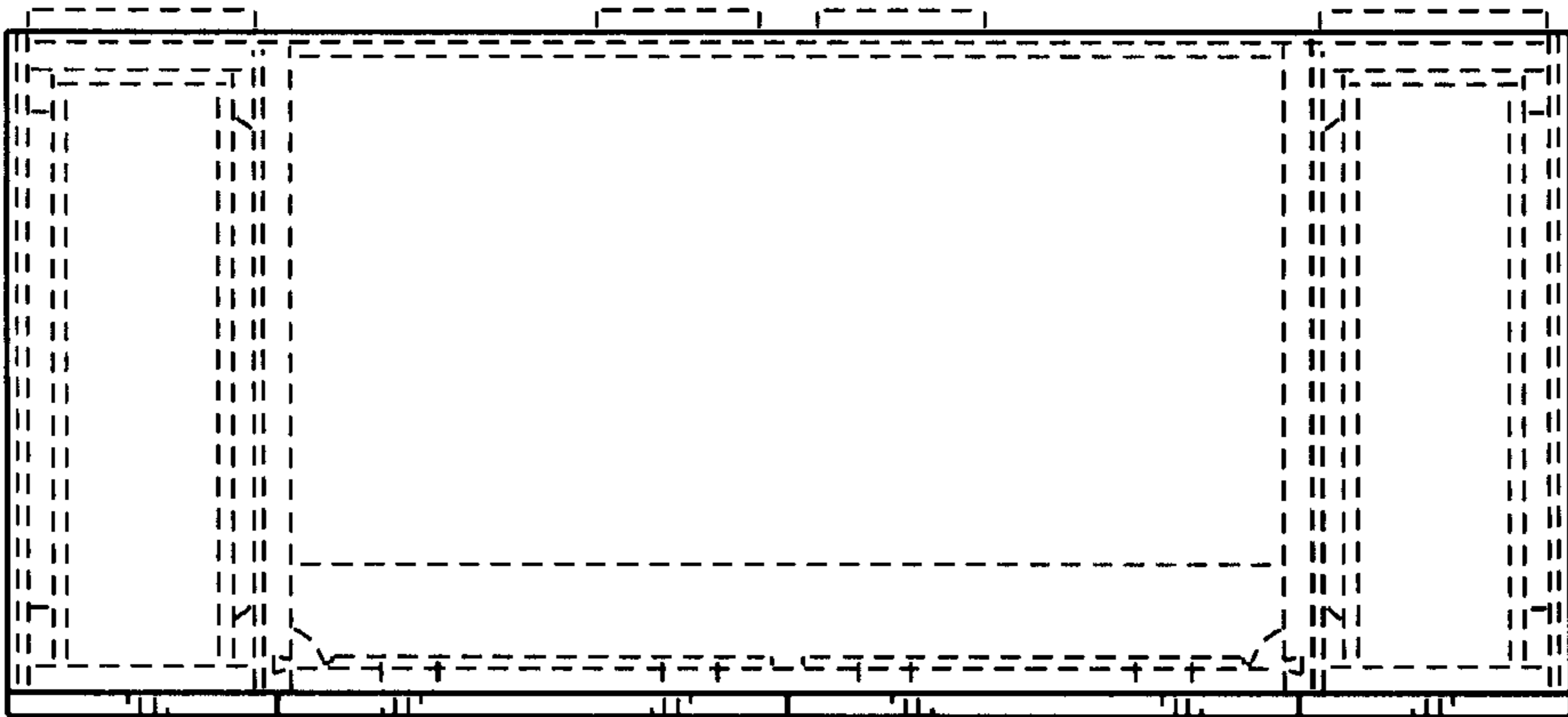

FIG. 19

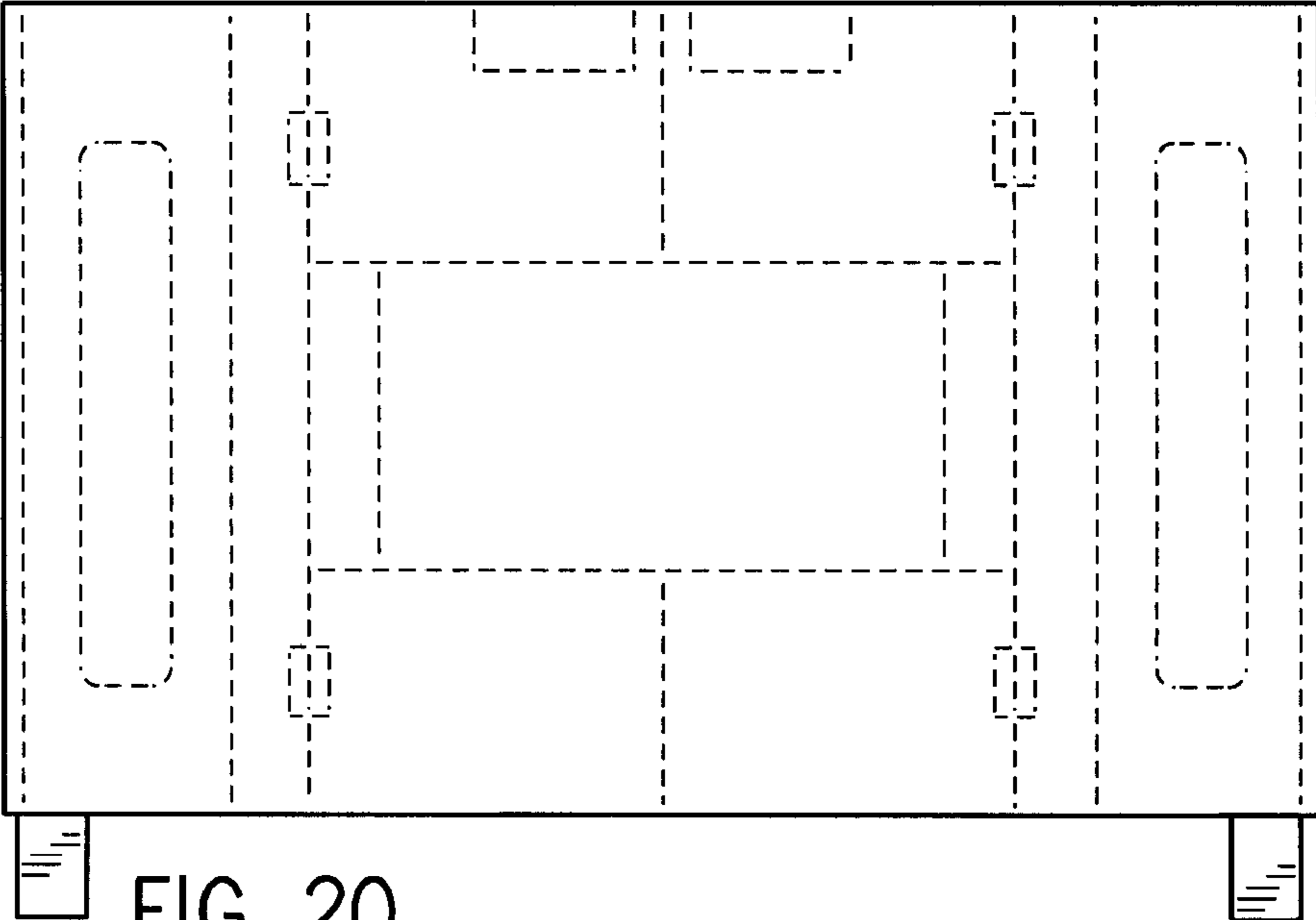

FIG. 20

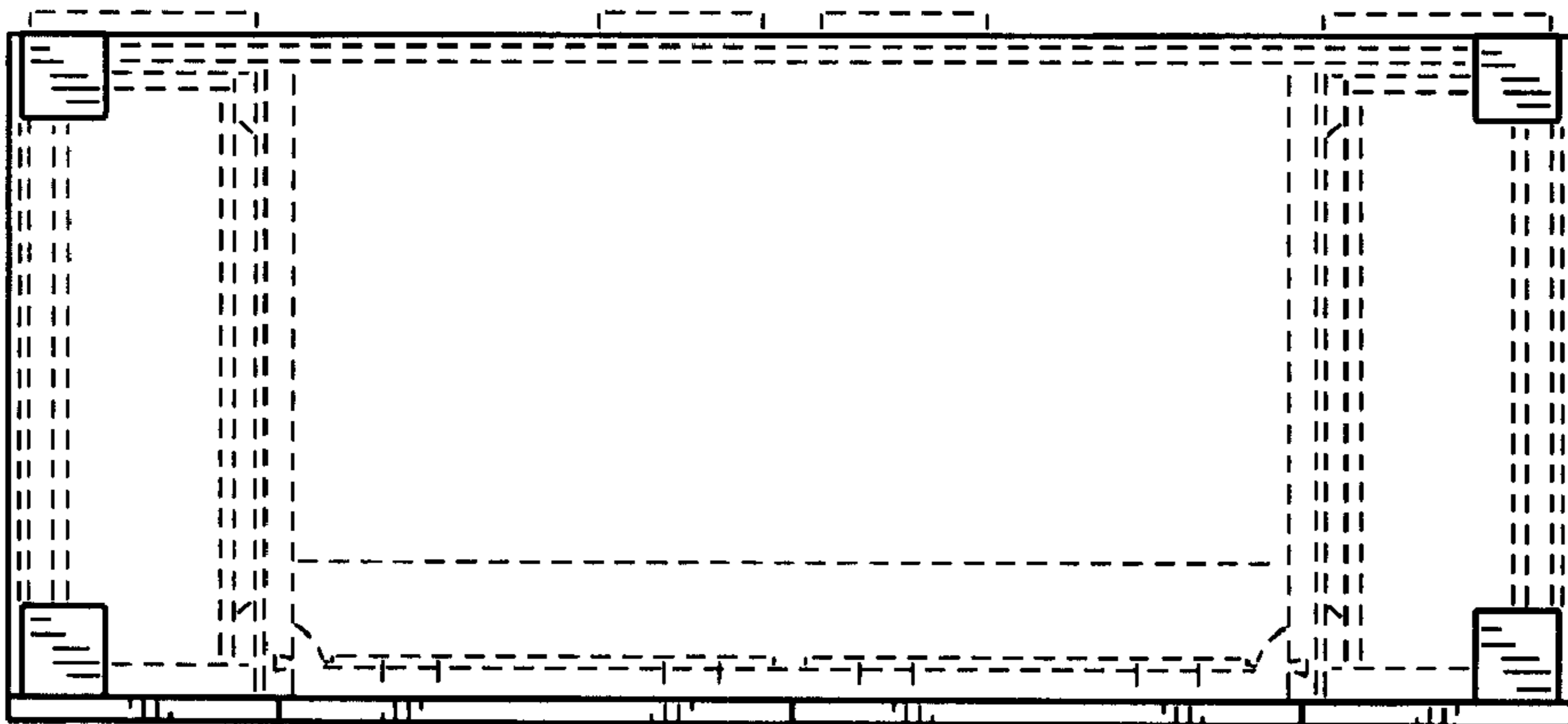

FIG. 21