



US00D579207S

(12) **United States Design Patent**
Jamson

(10) **Patent No.:** **US D579,207 S**
(45) **Date of Patent:** **** Oct. 28, 2008**

(54) **TOOTHBRUSH**

(75) Inventor: **Ari Syrquin Jamson**, Mexico City
(MX)

(73) Assignee: **Plasticos Y Tecnologia, S.A. De C.V.**,
Mexico City (MX)

(**) Term: **14 Years**

(21) Appl. No.: **29/306,750**

(22) Filed: **Apr. 15, 2008**

(30) **Foreign Application Priority Data**

Oct. 16, 2007 (MX) MX/F/2007/002230

(51) **LOC (8) Cl.** **04-02**

(52) **U.S. Cl.** **D4/107**

(58) **Field of Classification Search** D4/104-112,
D4/132-134, 136, 138; 15/110, 143.1, 167.1,
15/167.2; 132/308-311; 601/139, 141, 161;
D24/133, 146, 147, 152

See application file for complete search history.

(56) **References Cited**

U.S. PATENT DOCUMENTS

4,356,585	A	11/1982	Protell et al.	
D366,961	S *	2/1996	Barre	D4/108
D401,069	S *	11/1998	Lamond et al.	D4/104
D419,305	S *	1/2000	Porter et al.	D4/107
D428,704	S *	8/2000	Wildman	D4/107
D497,482	S *	10/2004	Porter et al.	D4/107

D499,554	S *	12/2004	Ramelli	D4/107
7,047,591	B2	5/2006	Hohlbein	
D531,414	S *	11/2006	Wong	D4/104
D531,809	S *	11/2006	Li	D4/104
7,174,596	B2 *	2/2007	Fischer et al.	15/110
2004/0134007	A1 *	7/2004	Davies	15/110

* cited by examiner

Primary Examiner—Cathron Brooks

Assistant Examiner—Lavone D Tabor

(74) *Attorney, Agent, or Firm*—Procopio, Cory, Hargreaves
& Savitch LLP

(57) **CLAIM**

The ornamental design for a toothbrush, as shown and described.

DESCRIPTION

FIG. 1 is a front view of a toothbrush showing my new design;

FIG. 2 is a bottom plan view thereof on an enlarged scale;

FIG. 3 is a top plan view thereof on an enlarged scale;

FIG. 4 is a rear elevation view thereof;

FIG. 5 is a right side elevation view thereof, the left side view being a mirror image thereof; and,

FIG. 6 is a front perspective view thereof.

The broken line showing of the bristles in FIGS. 1, 3, 5 and 6 is for illustrative purposes only and forms no part of the claimed design.

1 Claim, 5 Drawing Sheets

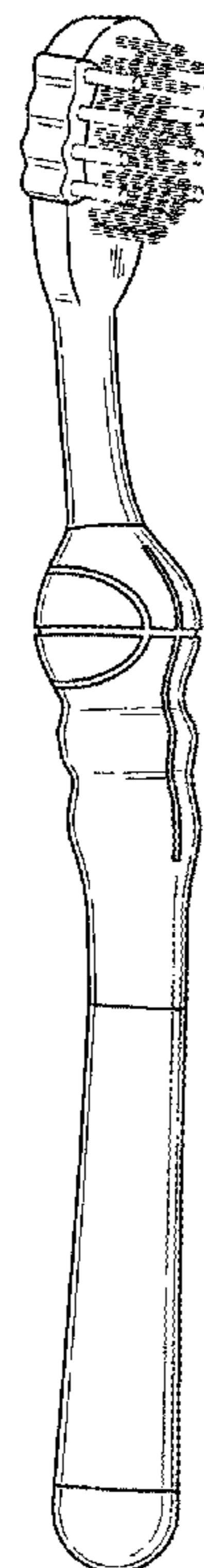
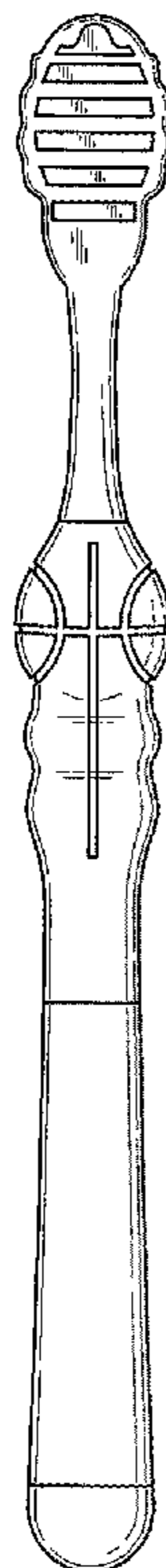

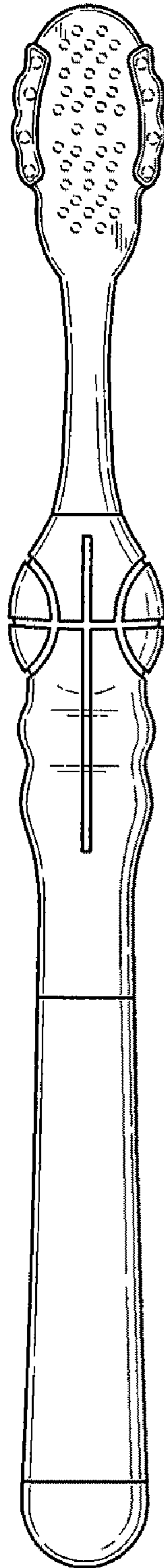

FIG. 1

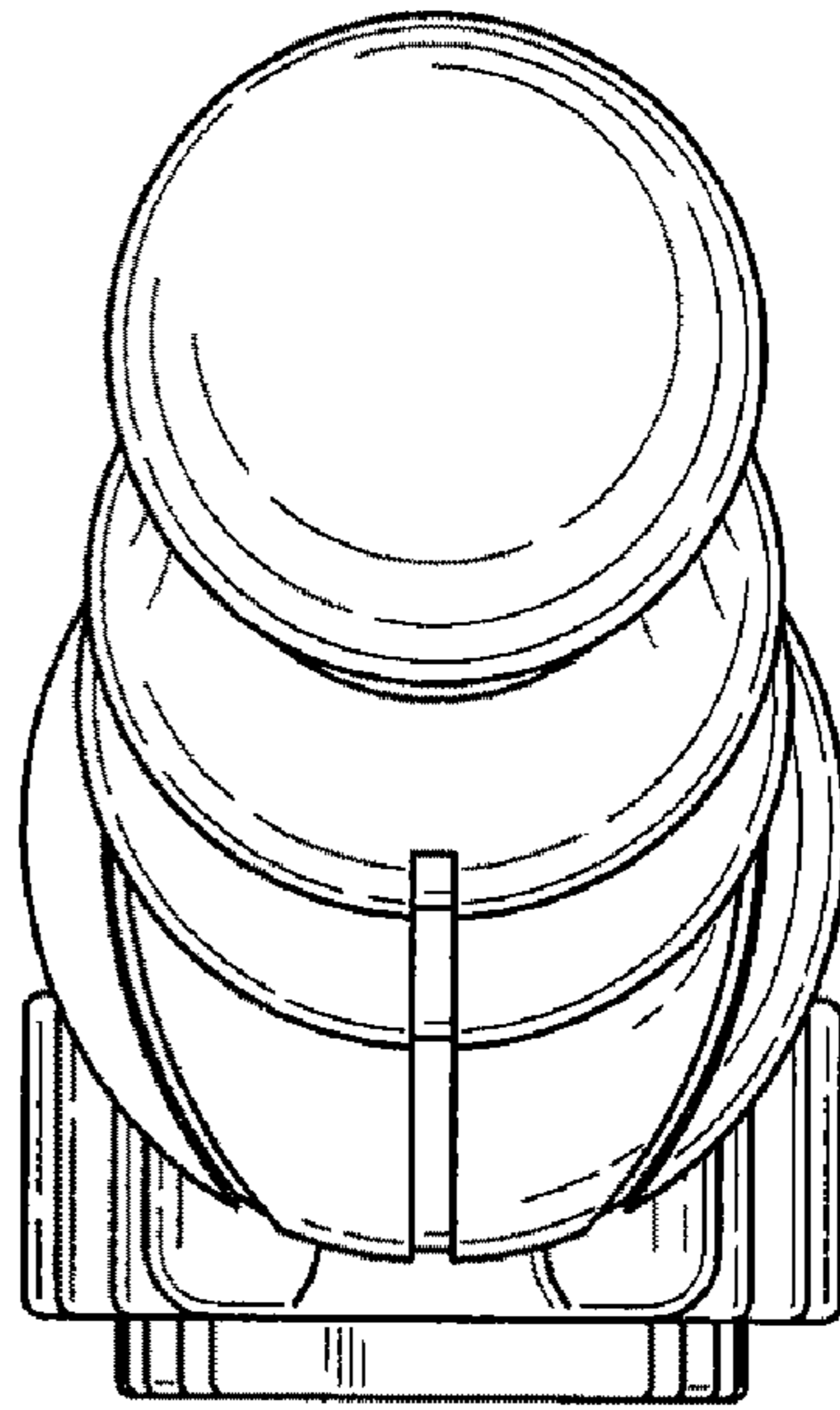

FIG. 2

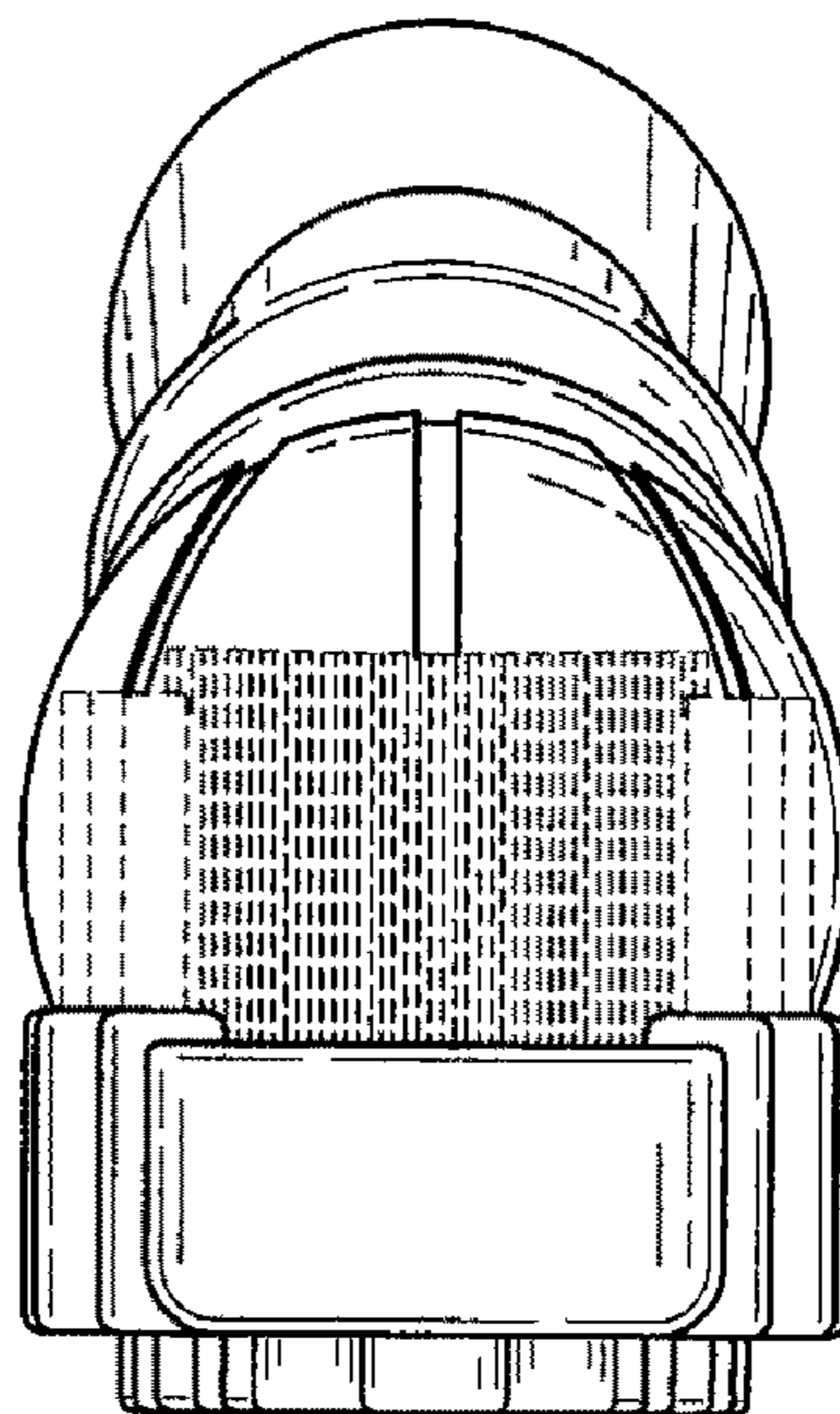

FIG. 3

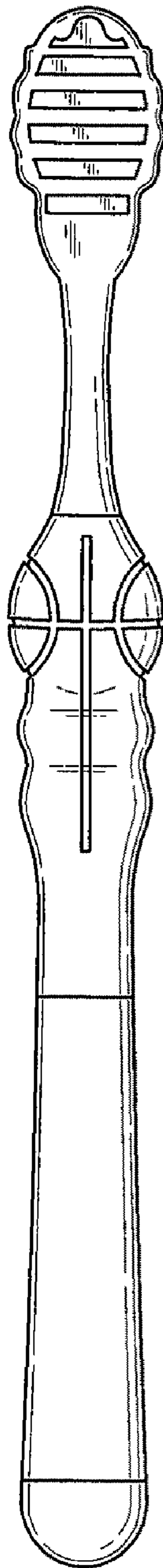

FIG. 4

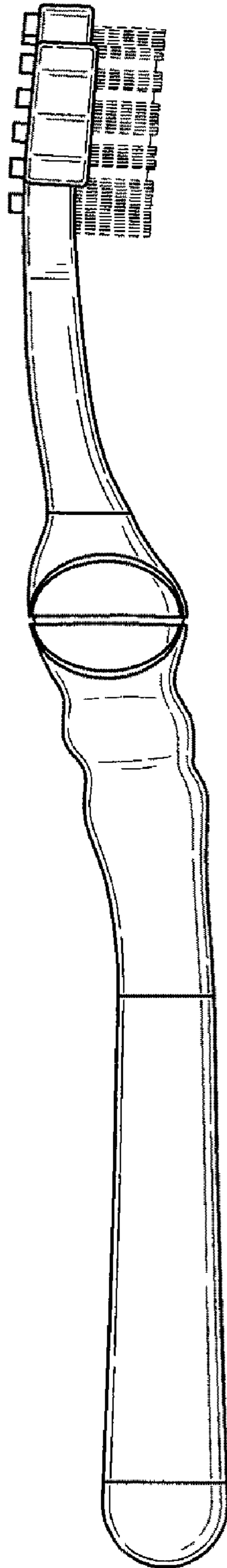

FIG. 5

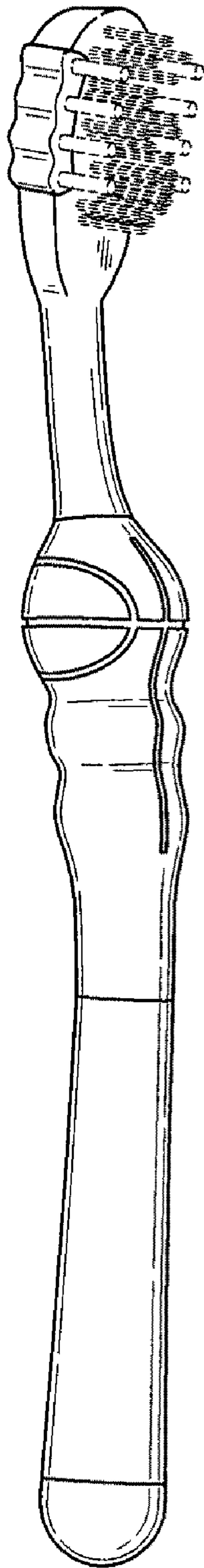

FIG. 6