



US00D579165S

(12) **United States Design Patent**
Handy et al.

(10) **Patent No.:** **US D579,165 S**
(45) **Date of Patent:** **** Oct. 21, 2008**

(54) **MOP**
(75) Inventors: **Joshua Handy**, Sausalito, CA (US);
Glenn May, Livermore, CA (US);
Stefanie Hermsdorf, Oakland, CA (US);
Karim Rashid, New York, NY (US)

(73) Assignee: **Method Products, Inc.**, San Francisco, CA (US)

(**) Term: **14 Years**

(21) Appl. No.: **29/299,440**

(22) Filed: **Dec. 26, 2007**

Related U.S. Application Data

(63) Continuation of application No. 29/278,189, filed on Mar. 21, 2007, now abandoned.

(51) **LOC (8) Cl.** **07-05**

(52) **U.S. Cl.** **D32/40**

(58) **Field of Classification Search** D32/40-42,
D32/50-52; 15/118, 244.1-244.4, 116.1-116.2,
15/119.1, 104.94, 98, 228, 320-321; 401/135-140;
206/209

See application file for complete search history.

(56) **References Cited**

U.S. PATENT DOCUMENTS

3,099,855	A	8/1963	Nash	
4,225,998	A	10/1980	Thielen	
4,852,210	A	8/1989	Krajicek	
5,001,802	A	3/1991	Humphrey	
5,461,749	A	10/1995	Ahlberg et al.	
D395,169	S *	6/1998	Yang	D4/137
5,791,006	A	8/1998	Anctil	
5,888,006	A	3/1999	Ping et al.	
6,044,513	A *	4/2000	Penn	15/118
6,487,747	B2	12/2002	Cavalheiro	

6,722,806	B2	4/2004	Kunkler et al.	
6,810,554	B2	11/2004	McKay	
6,871,372	B2 *	3/2005	Vosbikian et al.	15/115
D511,032	S *	10/2005	Roberts	D32/41
2004/0055099	A1	3/2004	Greenberg	
2005/0011536	A1	1/2005	Hofte et al.	
2005/0210627	A1	9/2005	Luebbering et al.	
2006/0000041	A1	1/2006	Streutker et al.	
2006/0016037	A1	1/2006	Flora et al.	
2006/0048327	A1	3/2006	Lacotta et al.	
2006/0075587	A1	4/2006	Broman	

* cited by examiner

Primary Examiner—Pamela J Burgess

(74) *Attorney, Agent, or Firm*—Cooley Godward Kronish

(57) **CLAIM**

We claim the ornamental design for a mop, substantially as shown and described.

DESCRIPTION

FIG. 1 is a front perspective view of a mop showing our new design;

FIG. 2 is a rear perspective view thereof;

FIG. 3 is an enlarged first top perspective view of the mop head portion, shown separately for clarity of disclosure;

FIG. 4 is an enlarged second top perspective view of the mop head portion thereof, shown separately for clarity of disclosure;

FIG. 5 is a bottom perspective view thereof;

FIG. 6 is a perspective view of the mop handle shown separately for clarity of disclosure; and,

FIG. 7 is a front perspective view of a second embodiment of a mop showing our new design.

The broken lines shown in the drawings are for illustrative purposes only and form no part of the claimed design.

1 Claim, 7 Drawing Sheets

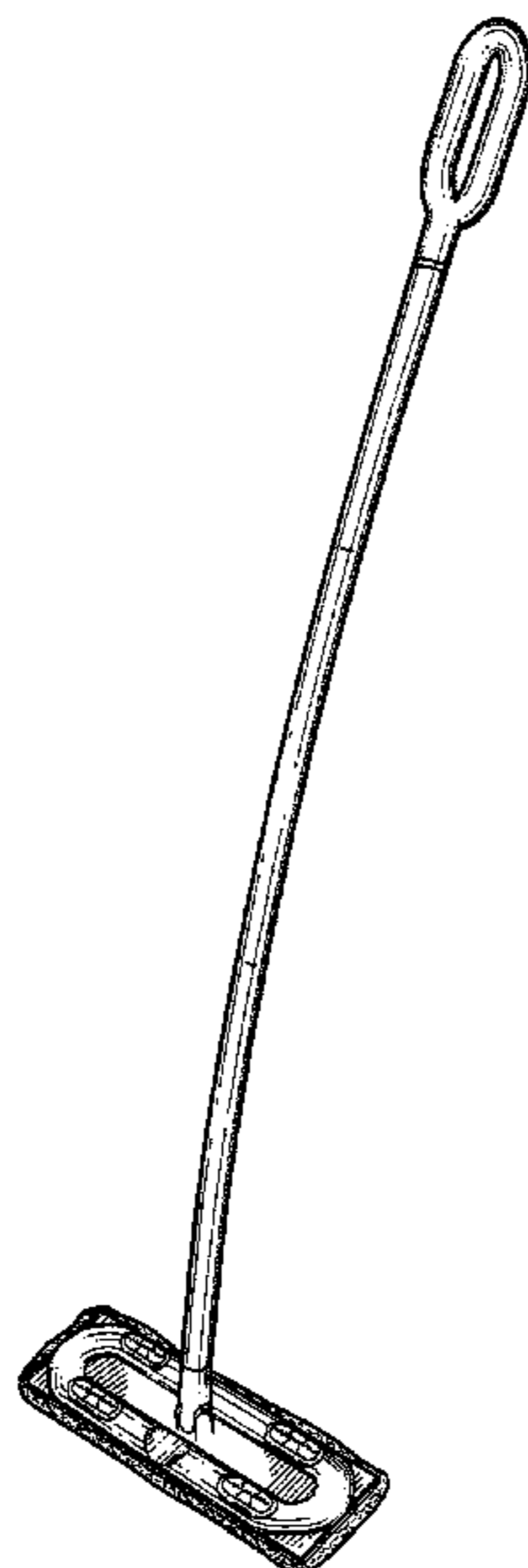

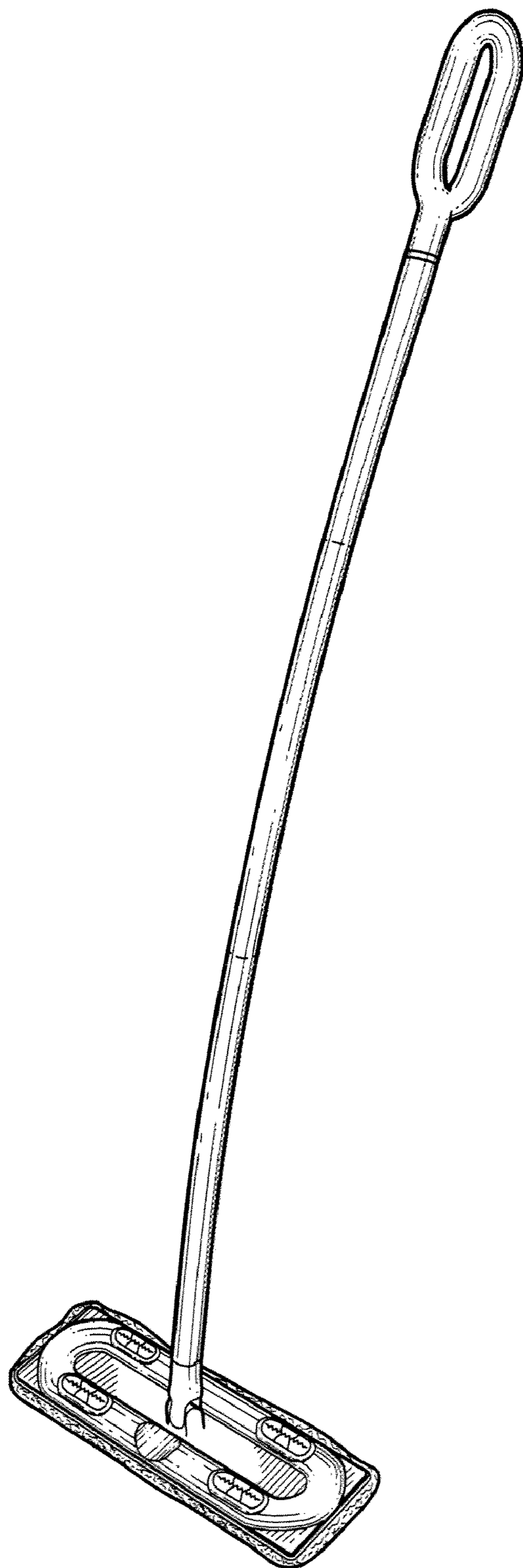

FIG. 1

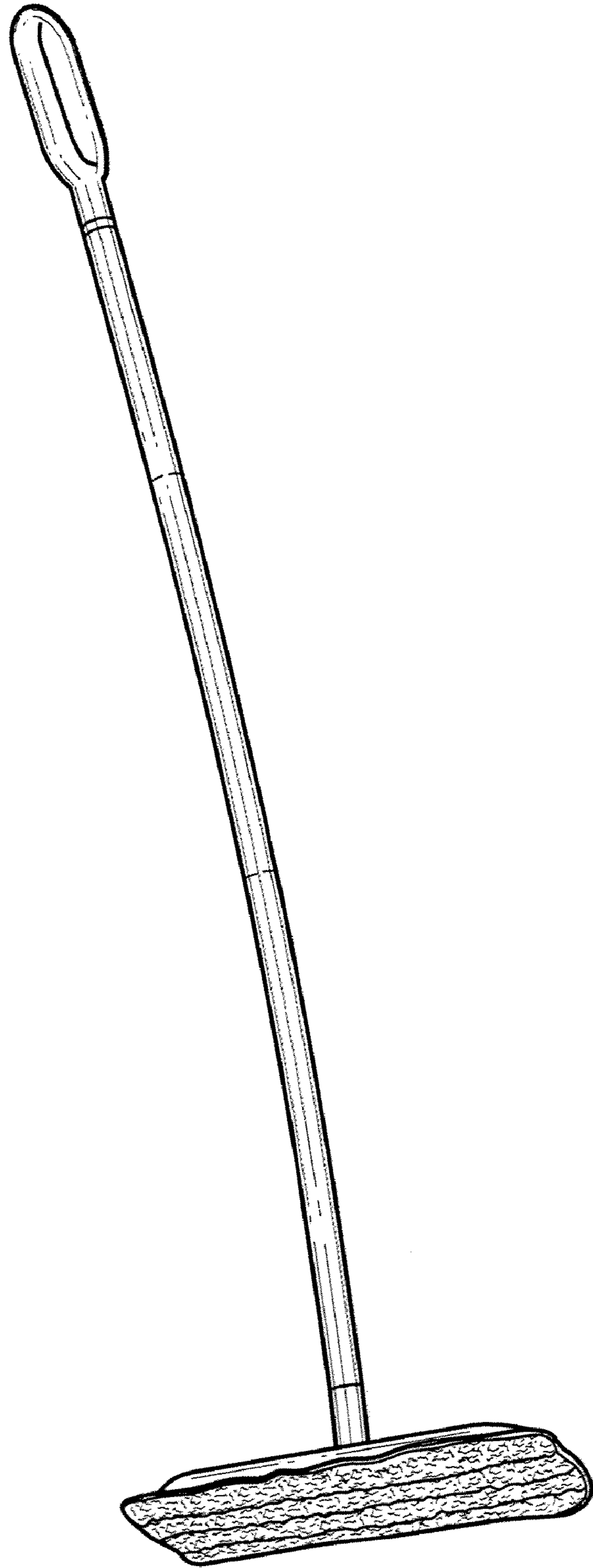

FIG. 2

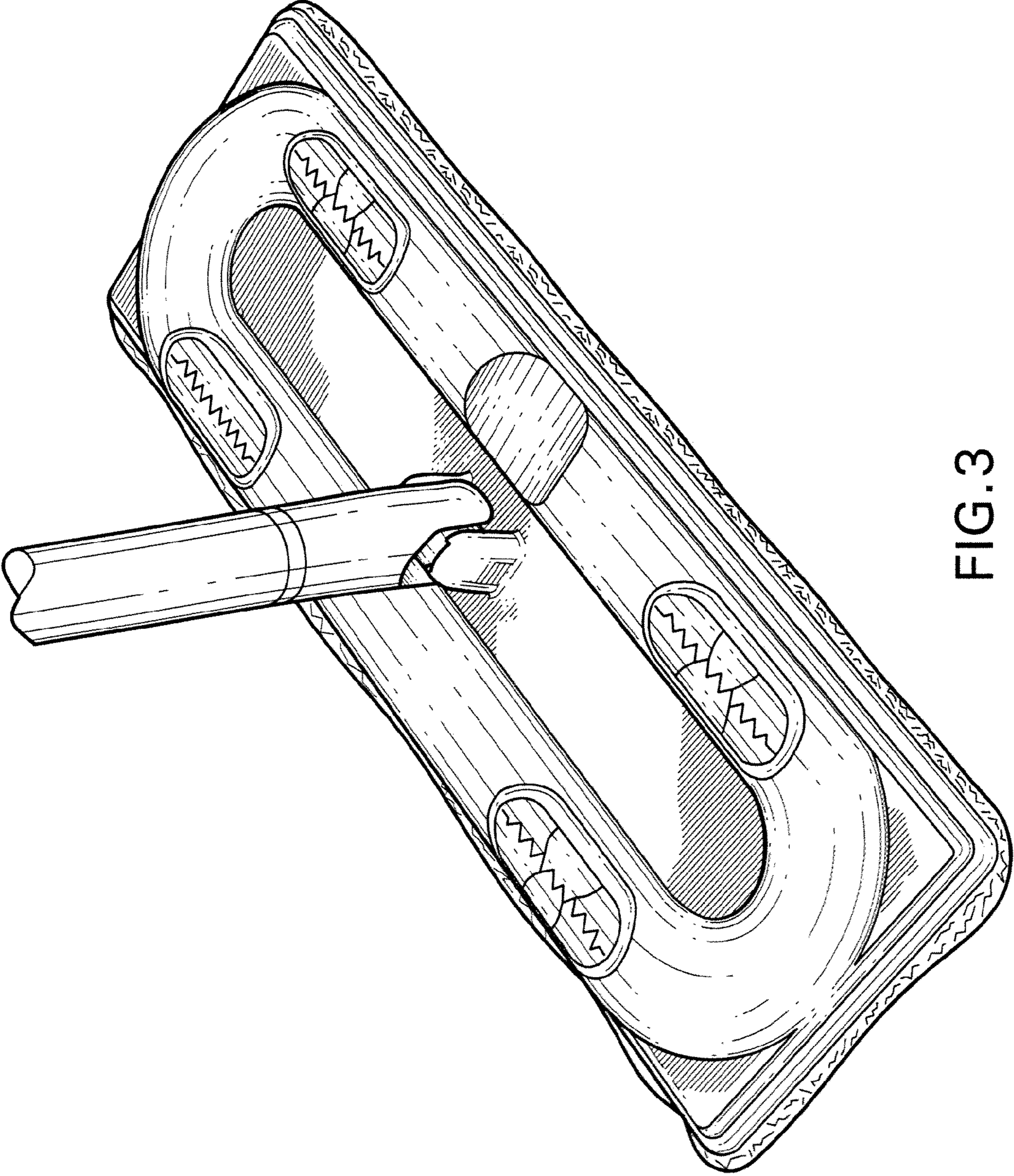

FIG. 3

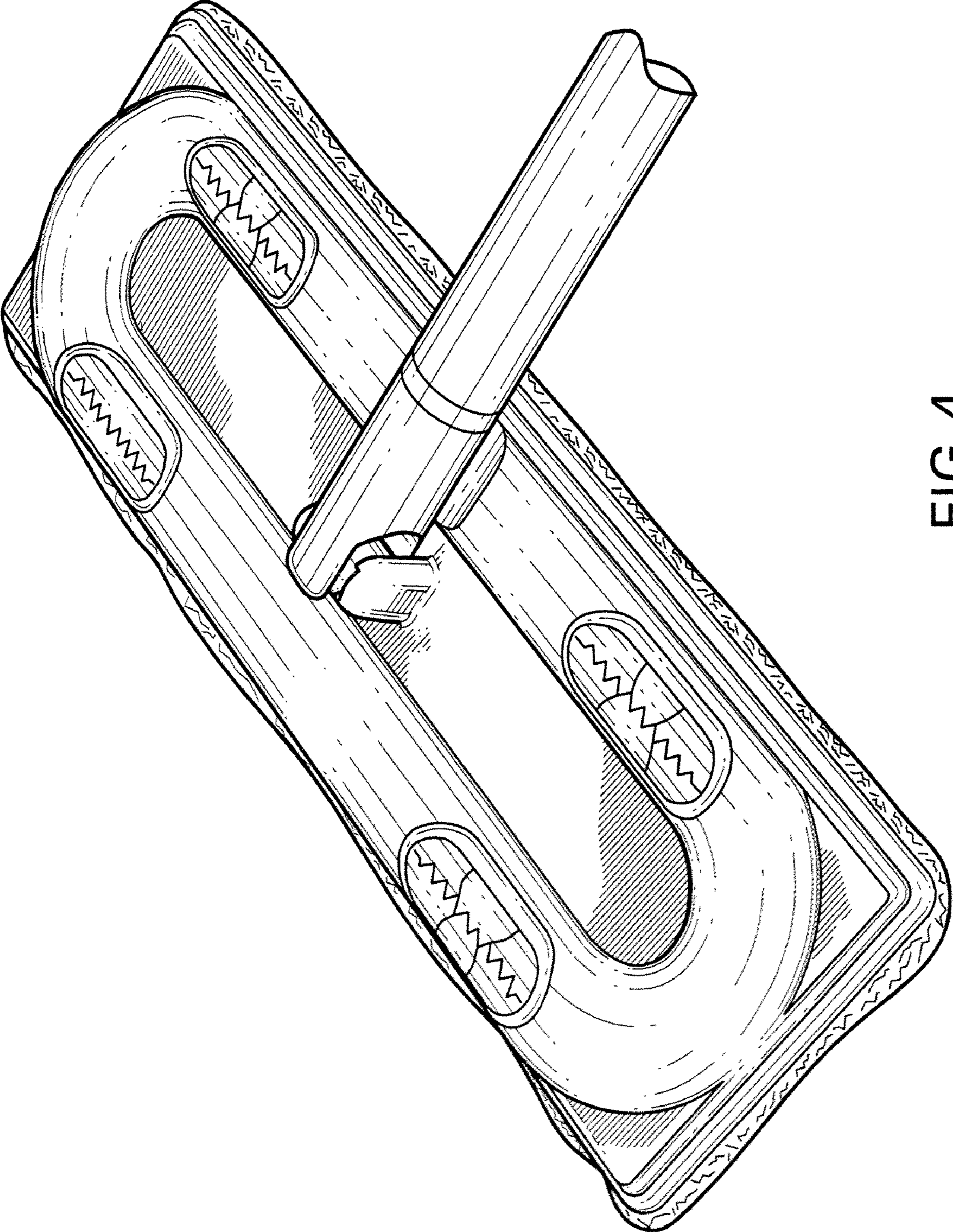

FIG.4

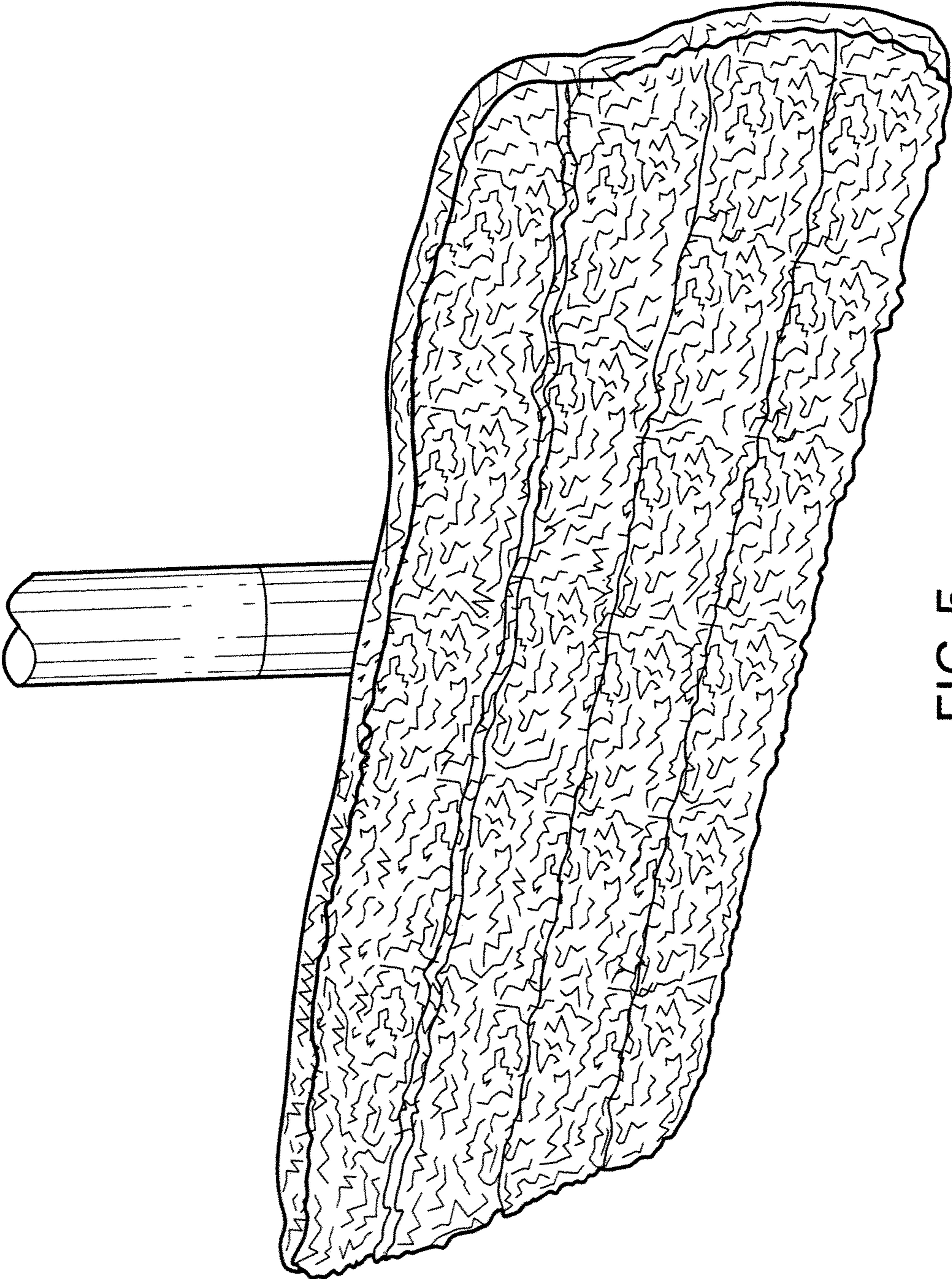

FIG. 5

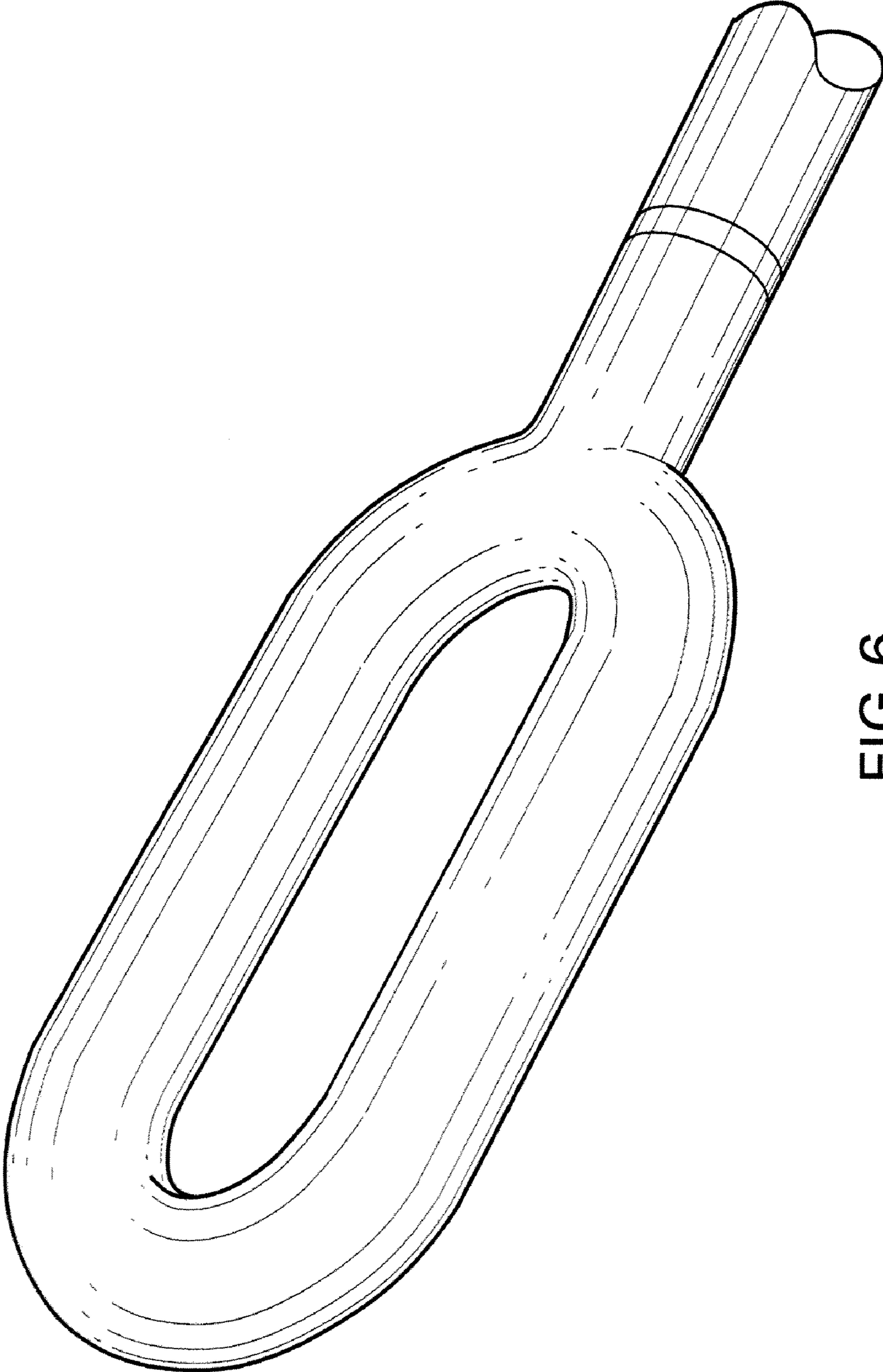

FIG. 6

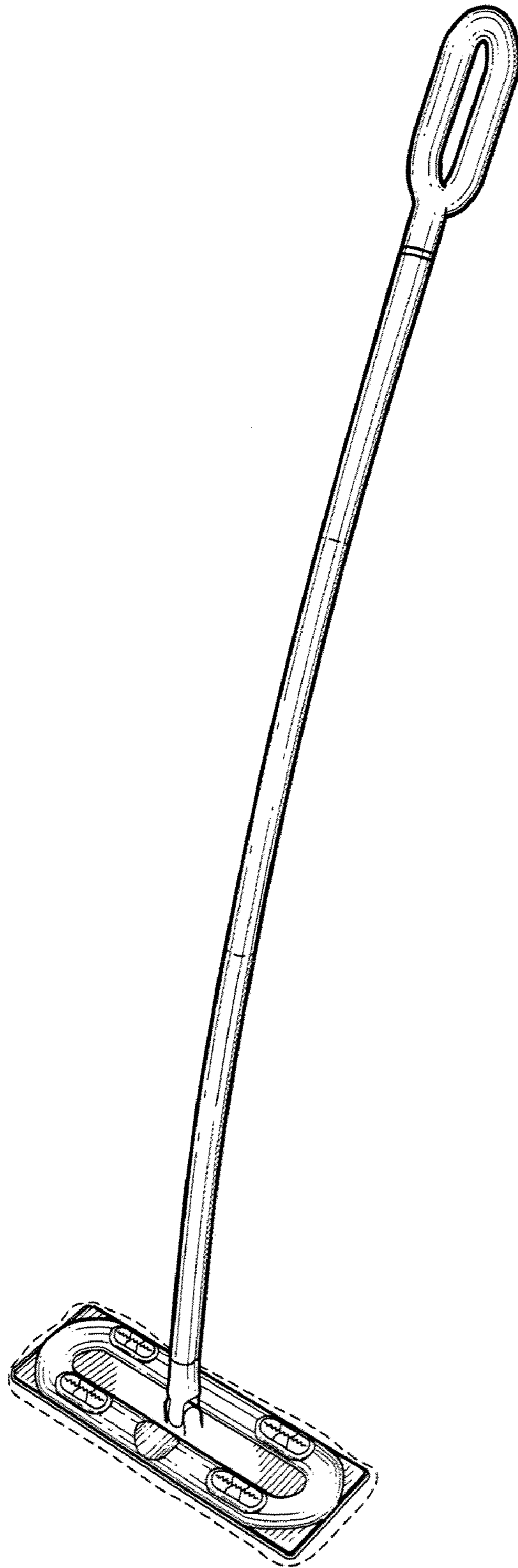

FIG. 7