



US00D579071S

(12) **United States Design Patent**  
**Oldknow et al.**

(10) **Patent No.:** **US D579,071 S**  
(45) **Date of Patent:** **\*\* Oct. 21, 2008**

(54) **GOLF CLUB HEAD FOR A PUTTER**

(75) Inventors: **Andrew G. V. Oldknow**, Beaverton, OR  
(US); **David N. Franklin**, Granbury, TX  
(US); **John T. Stites**, Weatherford, TX  
(US)

(73) Assignee: **Nike, Inc.**, Beaverton, OR (U\_

(\*\*) Term: **14 Years**

(21) Appl. No.: **29/321,328**

(22) Filed: **Jul. 15, 2008**

(51) **LOC (8) Cl.** ..... **21-02**

(52) **U.S. Cl.** ..... **D21/759**

(58) **Field of Classification Search** ..... D21/736-746,  
D21/759; 473/324-331, 340-341, 251-256  
See application file for complete search history.

(56) **References Cited**

**U.S. PATENT DOCUMENTS**

D93,862 S	11/1934	Barnhart	
D146,431 S	3/1947	Liolich	
D185,717 S	7/1959	Newton	
D298,767 S *	11/1988	Szczepanski	..... D21/744
D306,629 S	3/1990	Shearer	
D366,919 S	2/1996	Jacobs	
D377,675 S	1/1997	Abel	
D380,801 S	7/1997	Steele	
D389,539 S	1/1998	Moore	
D399,290 S	10/1998	Sizemore, Jr.	
D401,301 S	11/1998	Cherevko	
D425,158 S	5/2000	Long et al.	
D435,276 S	12/2000	Mantelli	
D437,624 S	2/2001	Tate	
6,716,110 B1	4/2004	Ballow	
D514,182 S	1/2006	Olsavsky et al.	
6,988,955 B2	1/2006	Stoakes	
D515,647 S	2/2006	Morgulis	
D520,583 S	5/2006	Rollinson et al.	
D522,599 S	6/2006	Johnson	
D523,502 S	6/2006	Jorgensen	
D529,108 S	9/2006	Stites et al.	

D538,866 S	3/2007	Kim et al.	
D540,410 S	4/2007	Sizemore, Jr.	
D549,293 S	8/2007	Rice et al.	
7,264,558 B2	9/2007	Kubica	
D557,361 S	12/2007	Rollinson	
D566,212 S	4/2008	Bardha	
D567,888 S	4/2008	Soracco	
D569,460 S	5/2008	Walker et al.	
D569,462 S	5/2008	Rollinson	
D571,420 S *	6/2008	Stites et al.	..... D21/742
D571,886 S *	6/2008	Stites et al.	..... D21/759
D572,331 S *	7/2008	Oldknow et al.	..... D21/759

(Continued)

**OTHER PUBLICATIONS**

Golf Smith Catalog, #4156 TGI System Putter, p. 72, dated 1998.  
Edwin Watts 2004 Holiday Catalog, Voodoo Daddy Putter #6064, p.  
54.  
Nike Edwin Watts Internet, Putters, Nike IC Series 20-20—Putter.

*Primary Examiner*—Mitchell I Siegel

(74) *Attorney, Agent, or Firm*—Banner & Witcoff, Ltd.

(57) **CLAIM**

The ornamental design for a golf club head for a putter, as shown and described.

**DESCRIPTION**

FIG. 1 is a top perspective view of a golf club head for a putter showing our new design;

FIG. 2 is a top plan view thereof;

FIG. 3 is a front view thereof;

FIG. 4 is a rear view thereof;

FIG. 5 is a toe end view thereof; and,

FIG. 6 is a heel end view thereof.

The broken line showing of the circular region within the shaded area and the remainder of the golf club head for a putter is for illustrative purposes only and forms no part of the claimed design.

**1 Claim, 2 Drawing Sheets**

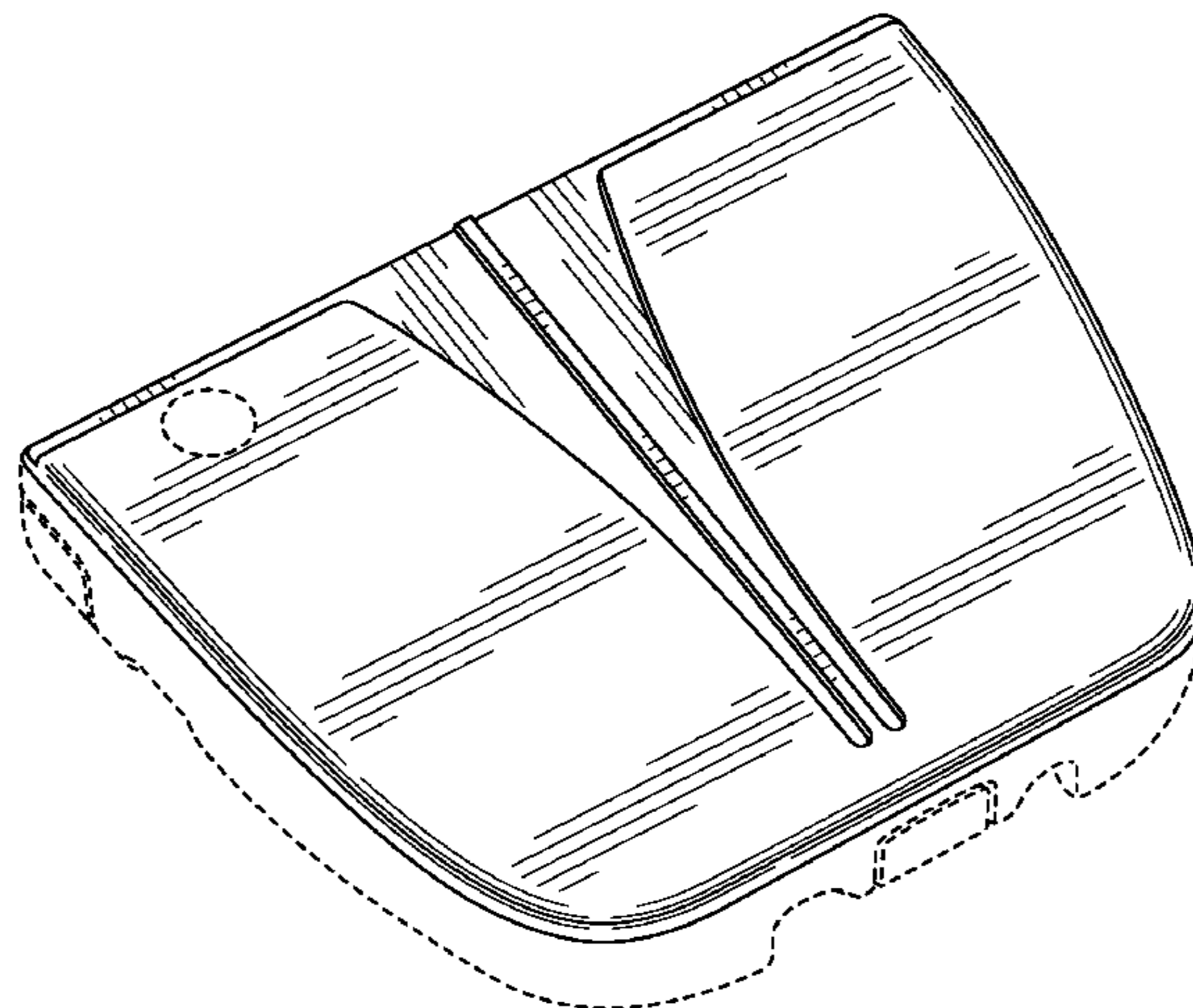

# US D579,071 S

Page 2

---

## U.S. PATENT DOCUMENTS

D572,789 S 7/2008 Stites et al.  
2002/0006833 A1 1/2002 Mason  
2004/0138003 A1 7/2004 Grace  
2006/0229140 A1 10/2006 Kubica et al.

2007/0238549 A1 10/2007 Johnson  
2007/0259734 A1 11/2007 Pollman  
2007/0293346 A1 12/2007 Rollinson et al.  
2008/0146369 A1 6/2008 Wahl et al.

\* cited by examiner

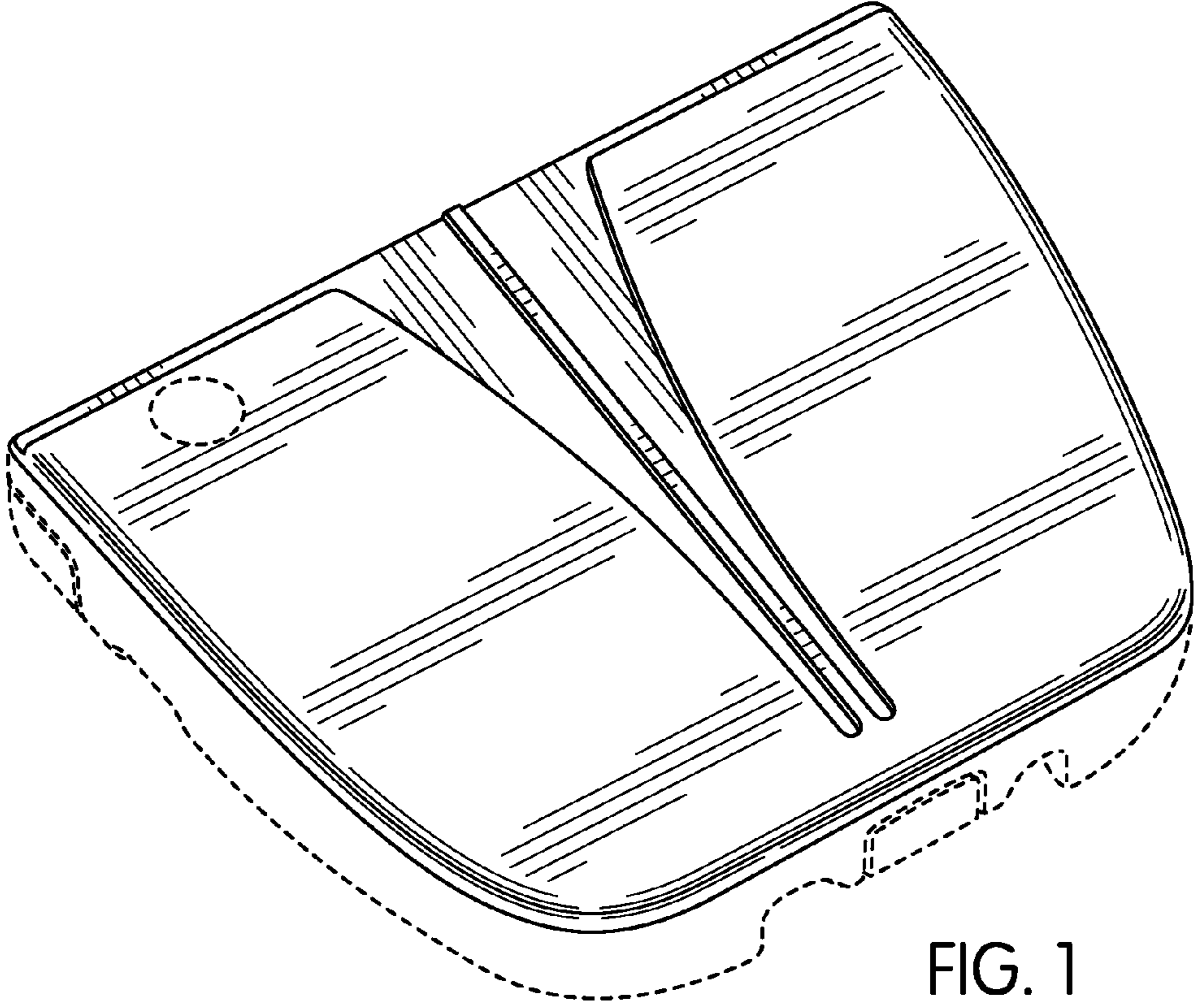

FIG. 1

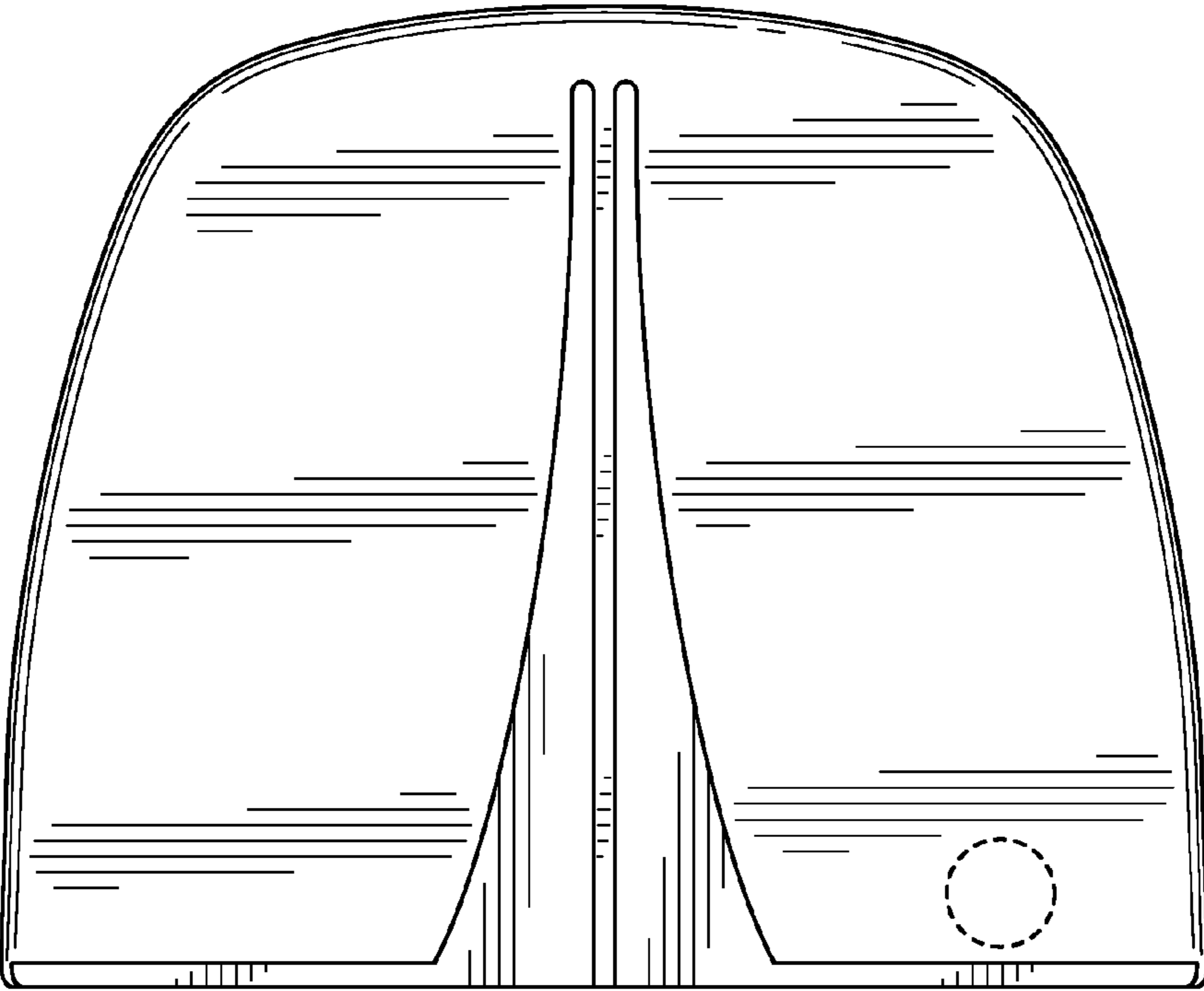

FIG. 2

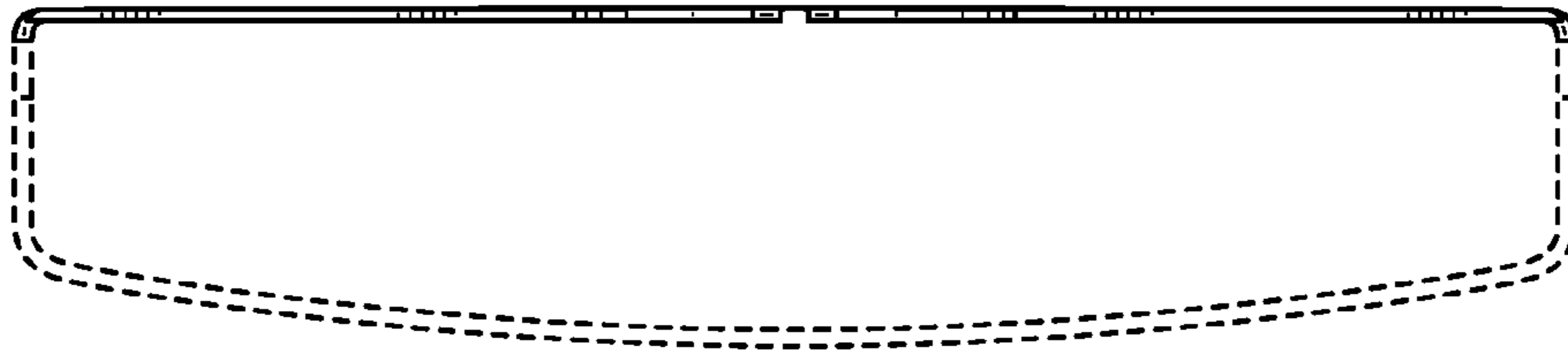

FIG. 3

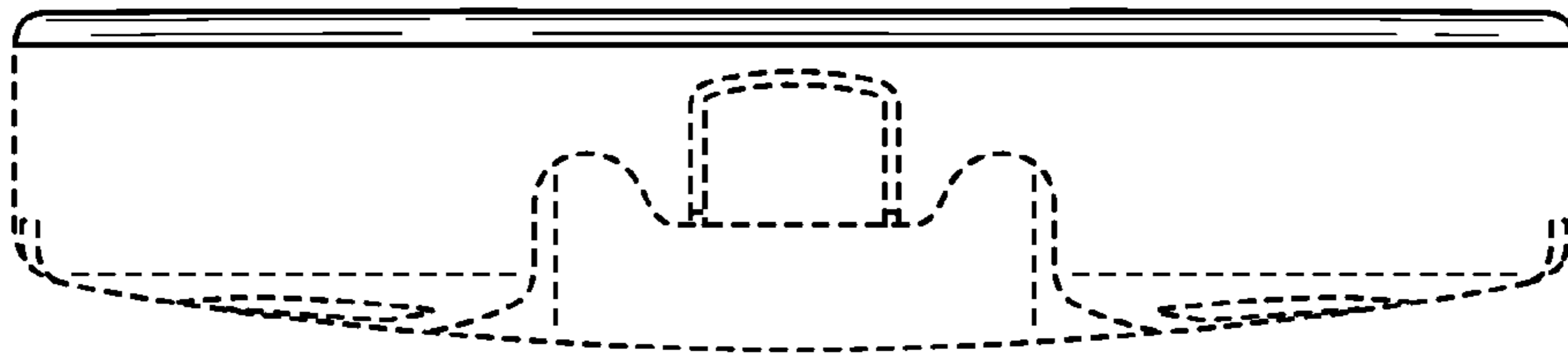

FIG. 4

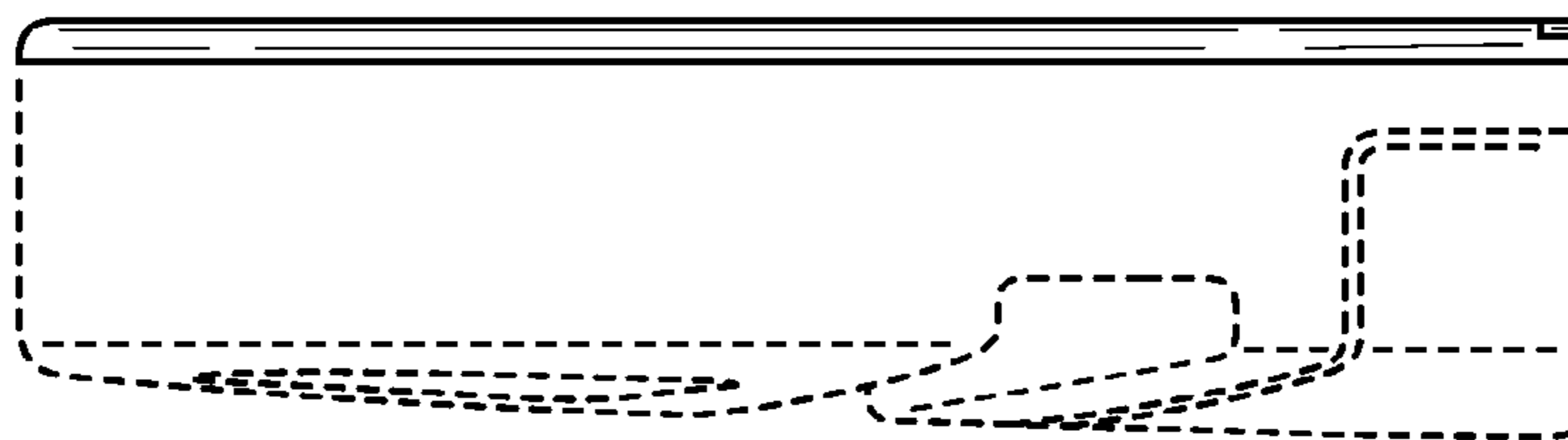

FIG. 5

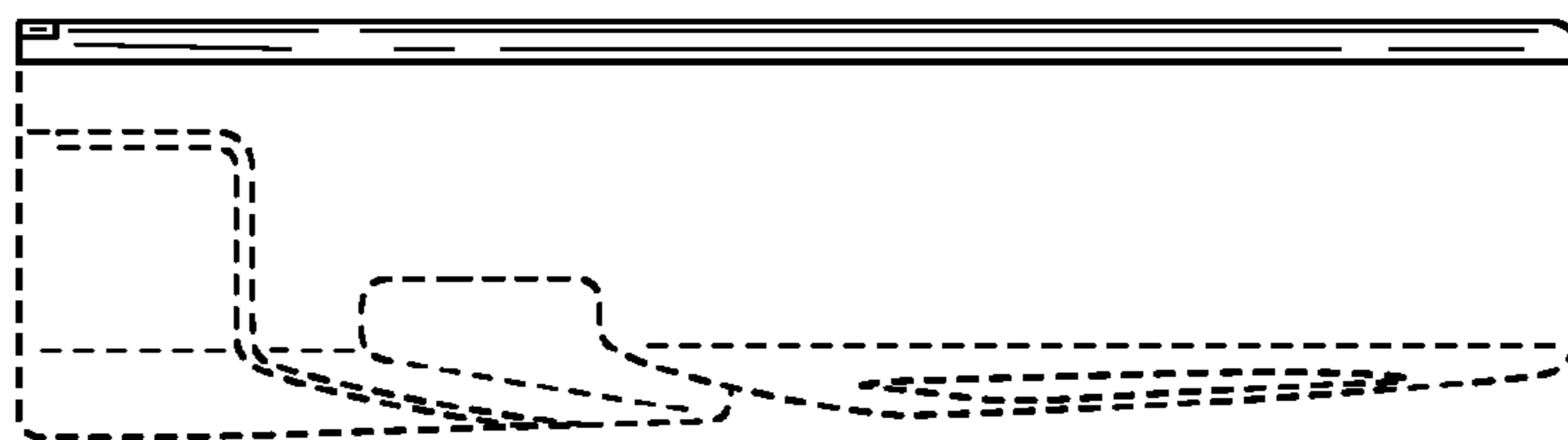

FIG. 6