



US00D579001S

(12) **United States Design Patent**  
**Gabrielsson**

(10) **Patent No.:** **US D579,001 S**

(45) **Date of Patent:** **\*\* Oct. 21, 2008**

(54) **SPEAKER**

D502,697 S \* 3/2005 Hite ..... D14/214  
D527,722 S \* 9/2006 Yeh ..... D14/215

(75) Inventor: **Marcus Gabrielsson**, Stockholm (SE)

(73) Assignee: **Plastoform Industries Ltd.**, Kwai  
Chung, New Territories, Hong Kong  
(CN)

\* cited by examiner

*Primary Examiner*—Nanda Bondade

(74) *Attorney, Agent, or Firm*—Alix, Yale & Ristas, LLP

(\*\*) Term: **14 Years**

(21) Appl. No.: **29/272,898**

(57) **CLAIM**

The ornamental design for a speaker, as shown and described.

(22) Filed: **Feb. 20, 2007**

(30) **Foreign Application Priority Data**

**DESCRIPTION**

Dec. 19, 2006 (HK) ..... 0603339

(51) **LOC (8) Cl.** ..... **14-01**

FIG. 1 is a front elevational view of a speaker showing my new design;

(52) **U.S. Cl.** ..... **D14/214**

FIG. 2 is a rear elevational view thereof;

(58) **Field of Classification Search** ..... D14/204,  
D14/207, 209–216; 181/143–144, 147–148,  
181/150, 157, 198–199, 151, 153; 381/300–302,  
381/306, 333, 345, 361–364, 386–388, 332,  
381/336

FIG. 3 is a left side elevational view thereof;

FIG. 4 is a right side elevational view thereof;

FIG. 5 is a top plan view thereof; and,

FIG. 6 is a bottom plan view thereof.

See application file for complete search history.

The broken line showing on the drawing disclosure is for illustrative purposes only and forms no part of the claimed design.

(56) **References Cited**

**U.S. PATENT DOCUMENTS**

6,504,938 B1 \* 1/2003 Anderson et al. .... 181/145

**1 Claim, 4 Drawing Sheets**

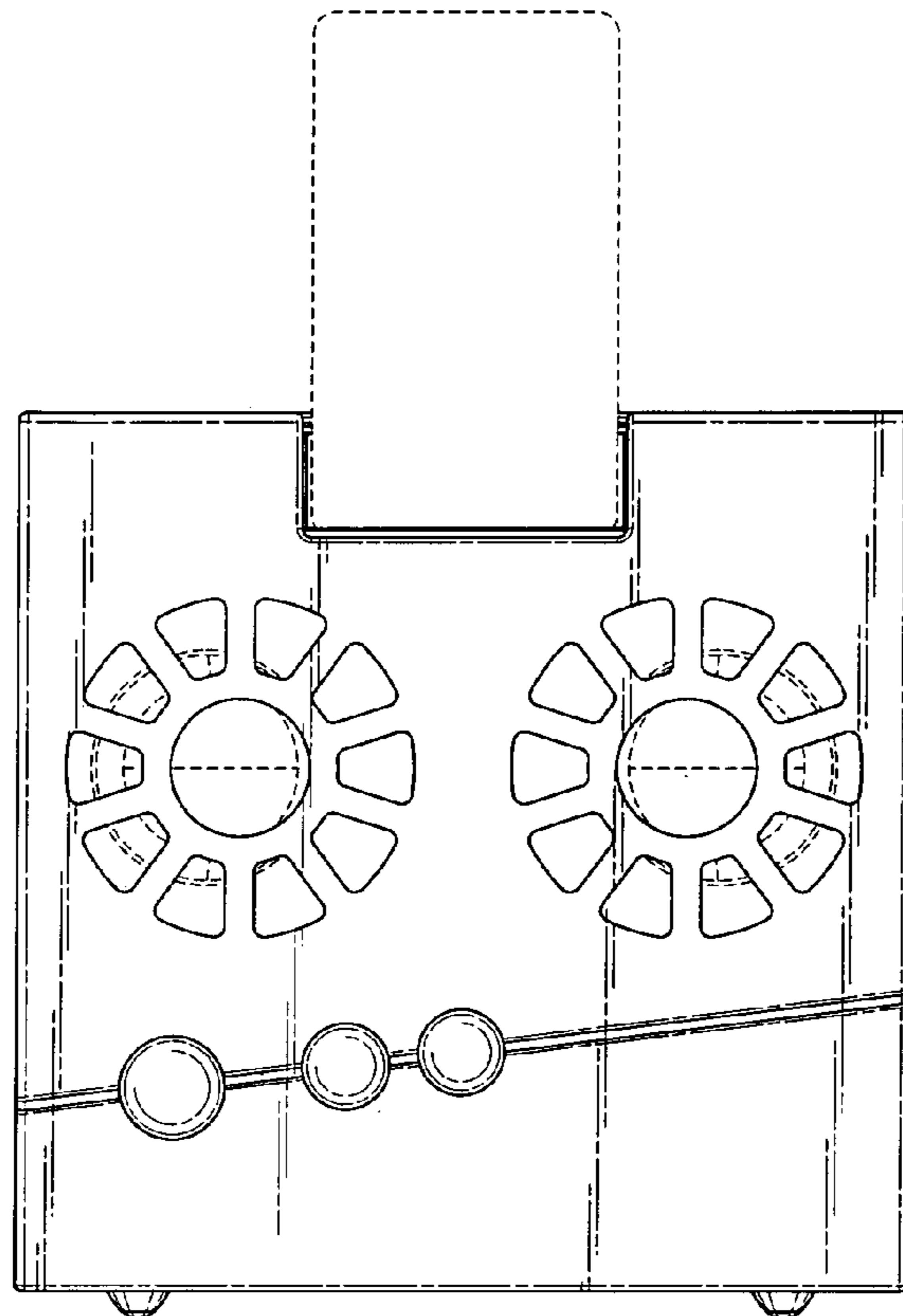

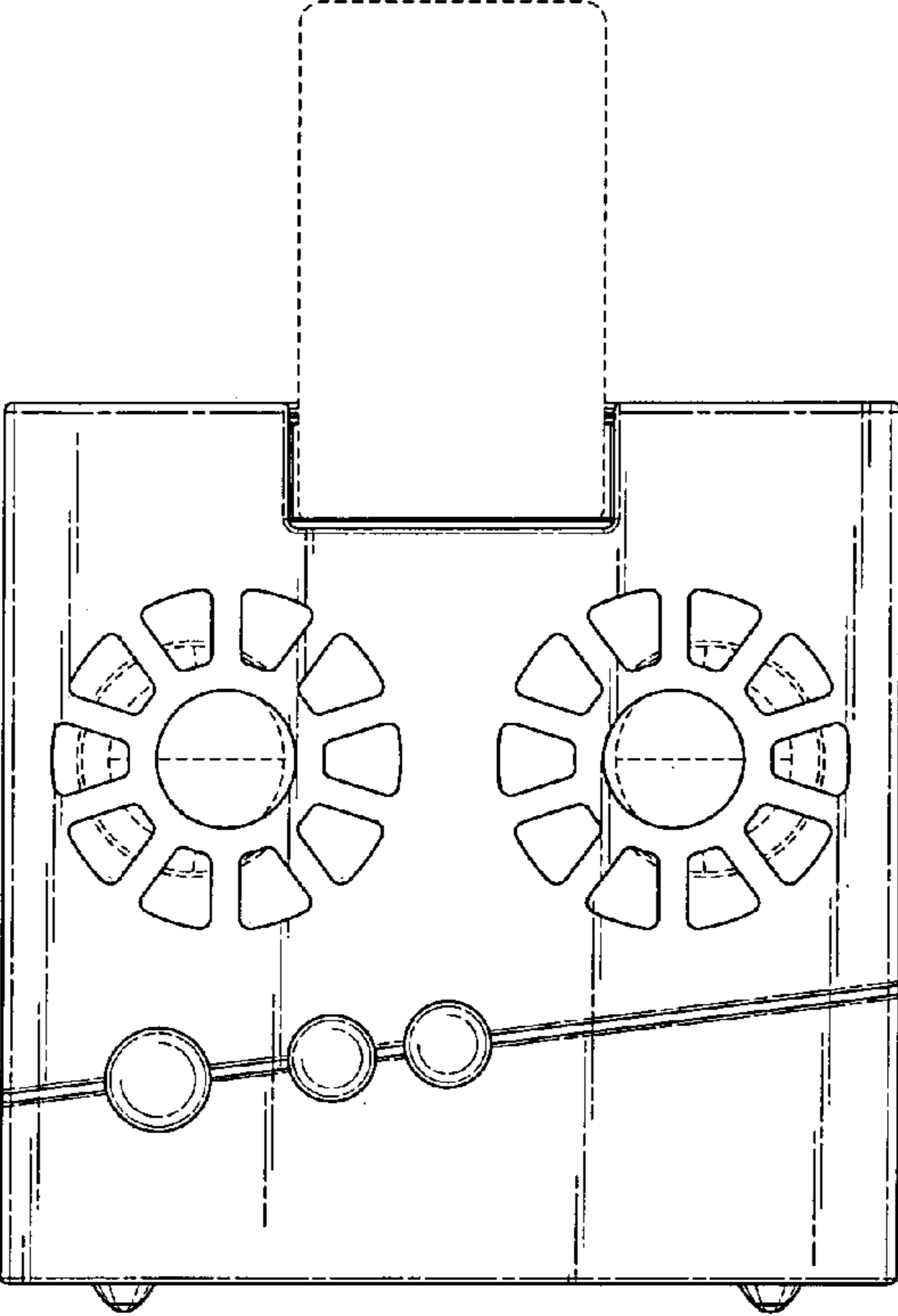

FIG. 1

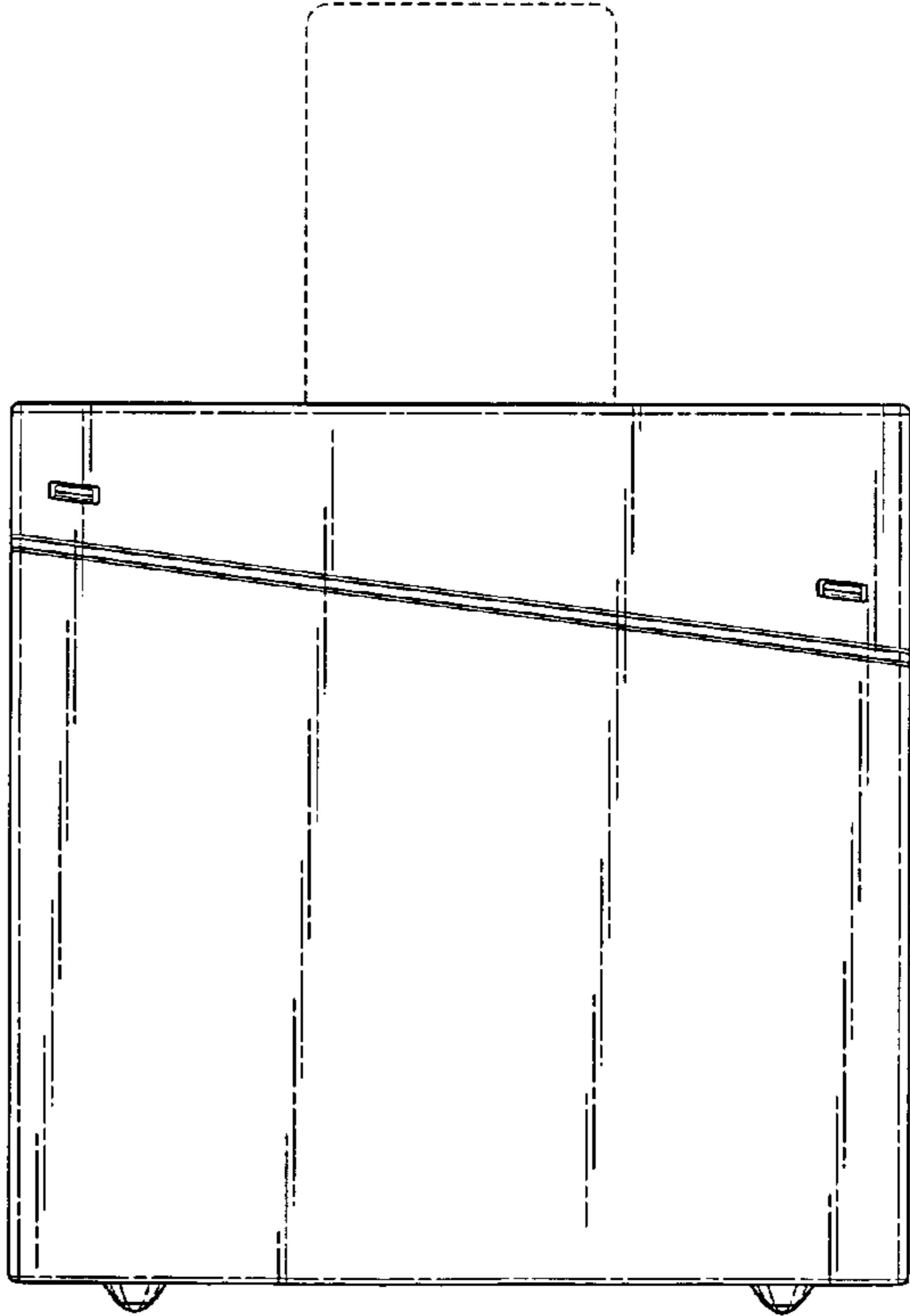

FIG. 2

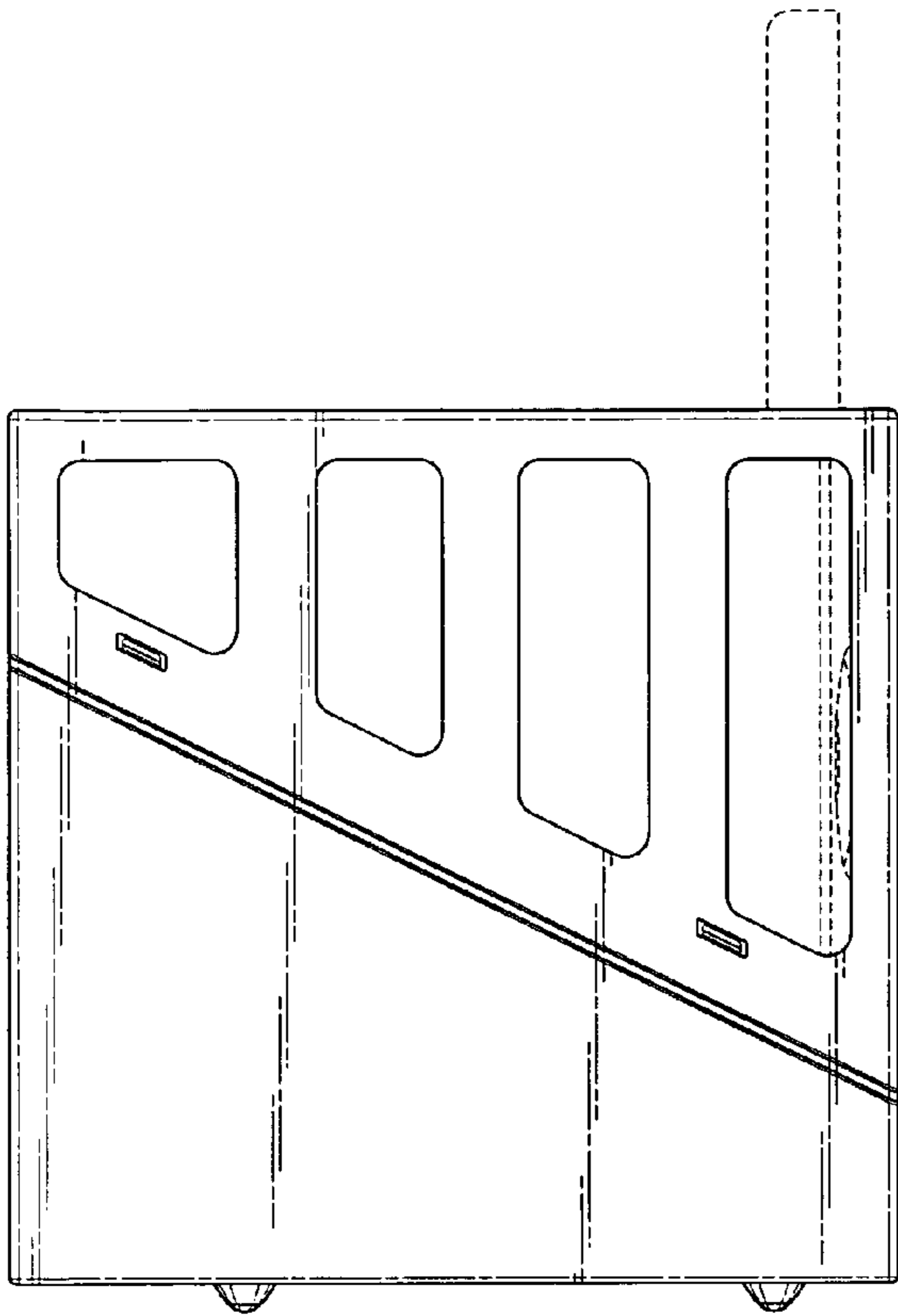

FIG. 3

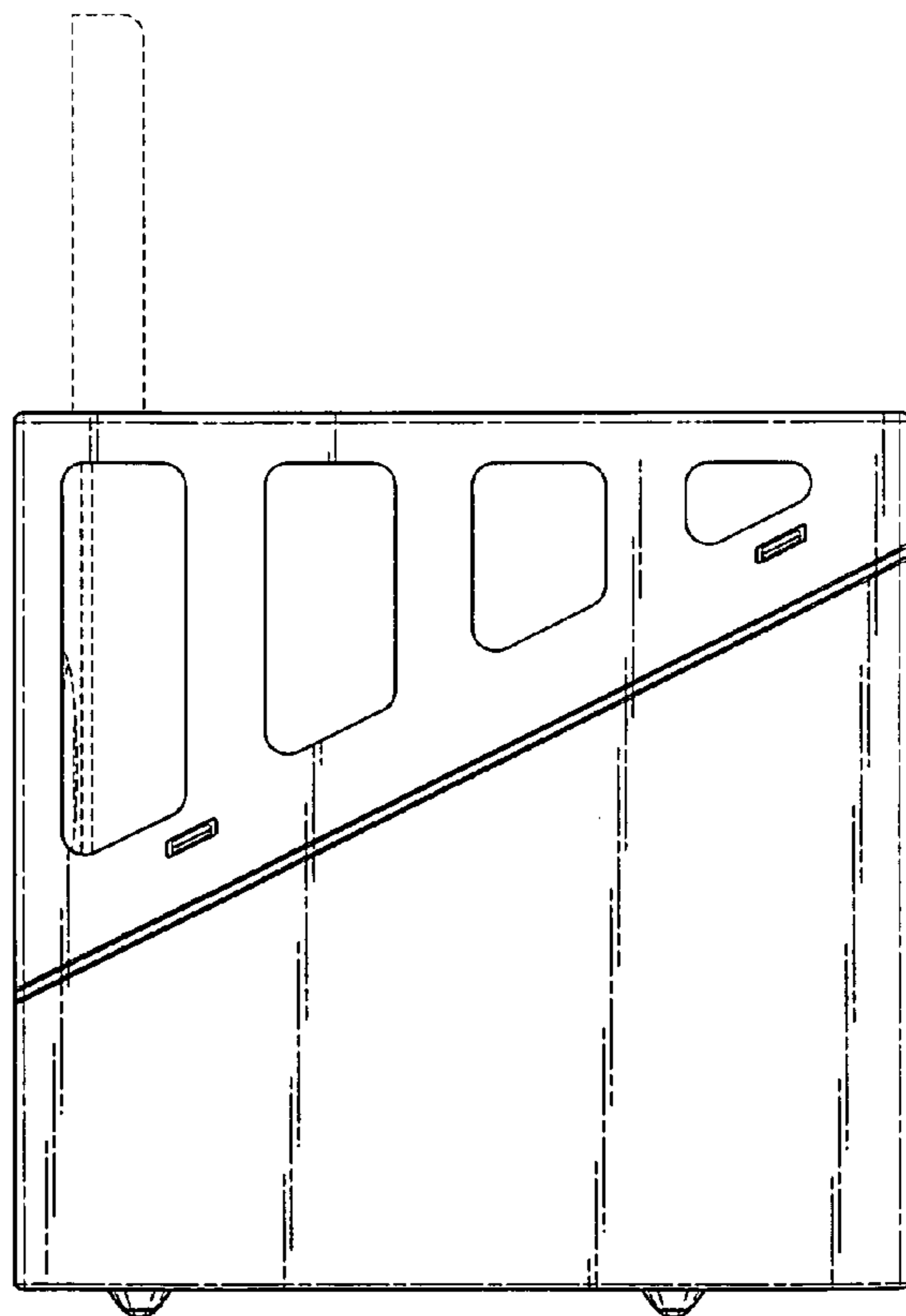

FIG. 4

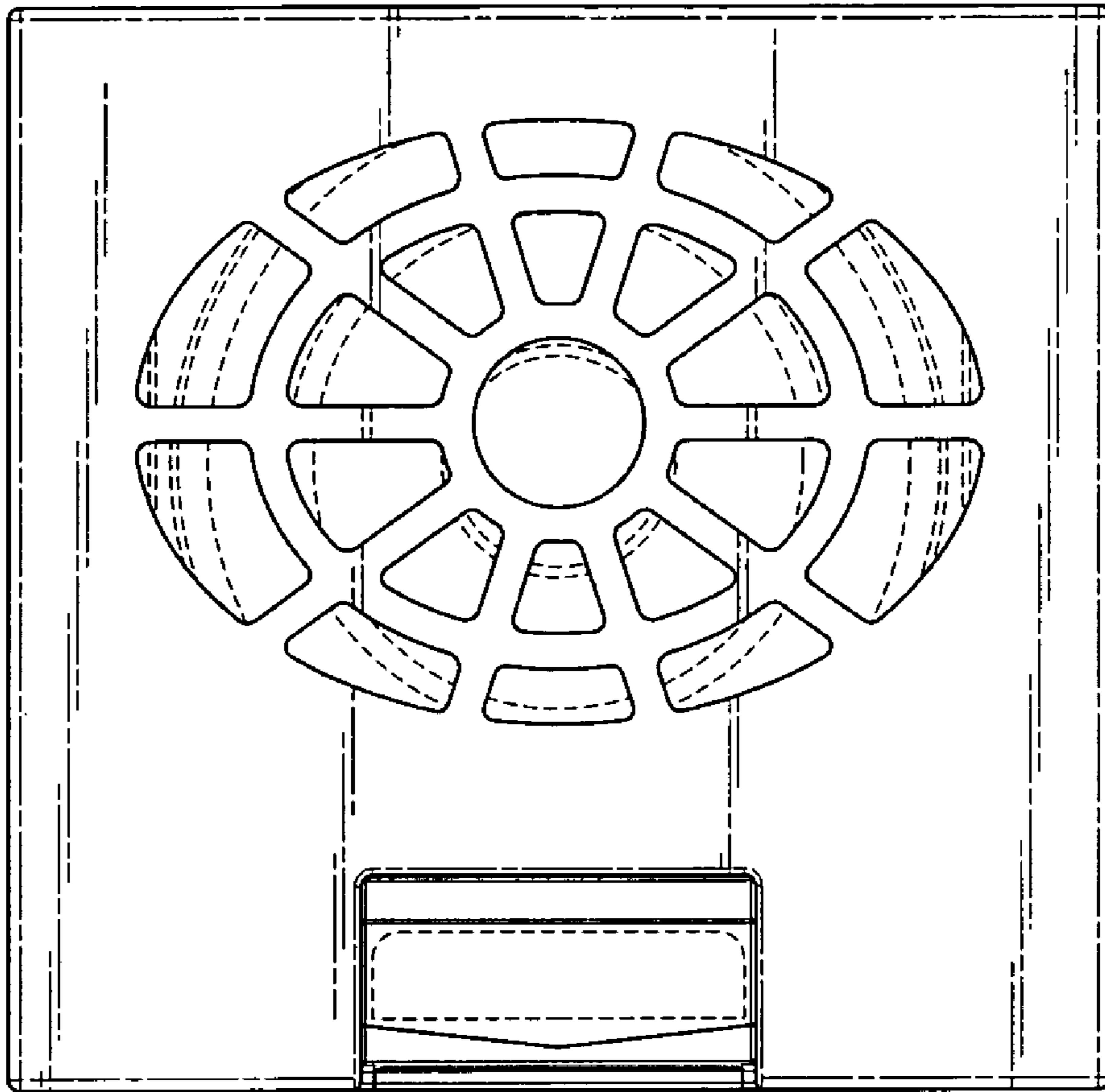

FIG. 5

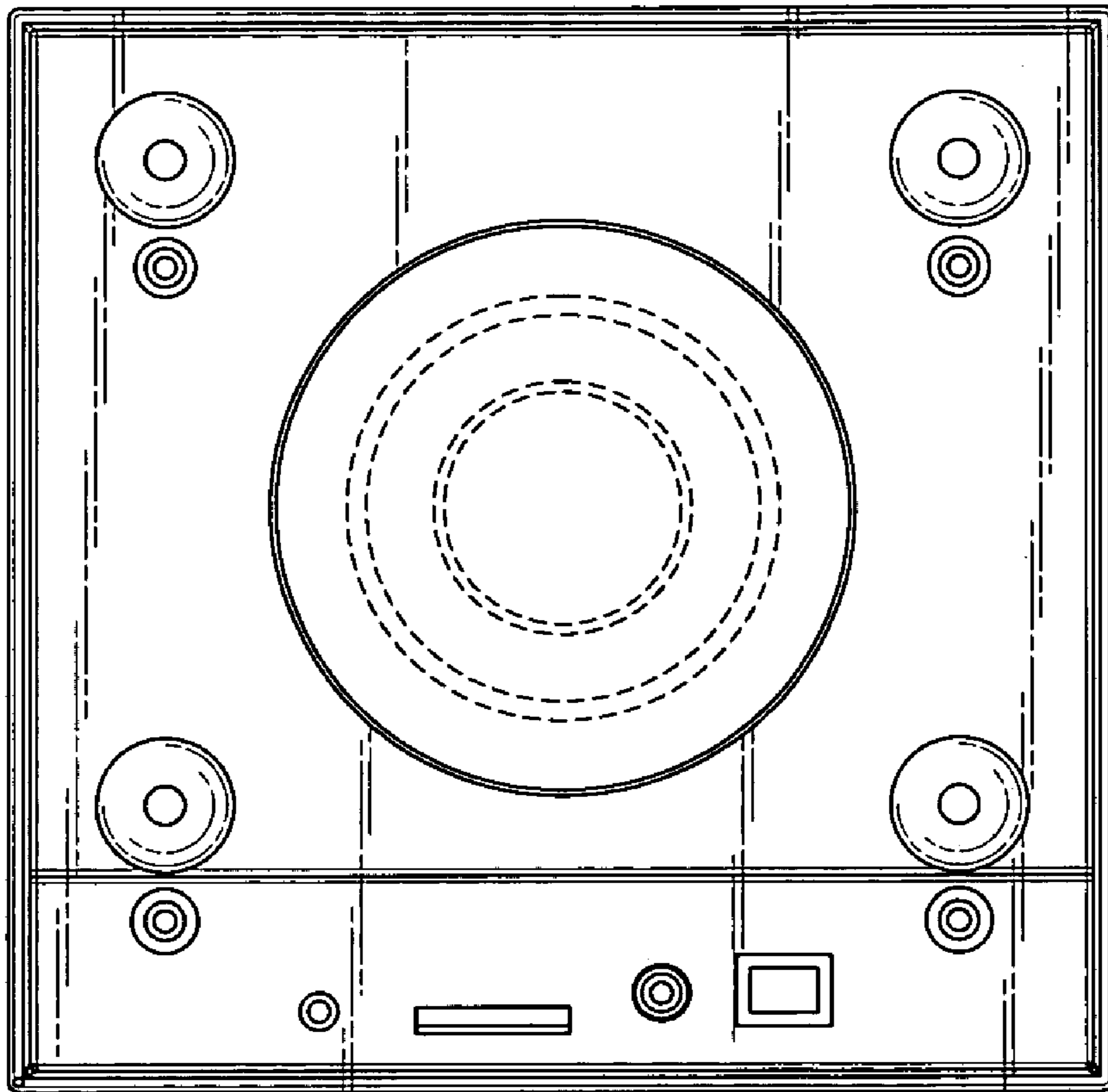

FIG. 6