



US00D578985S

(12) **United States Design Patent**  
**Kim et al.**

(10) **Patent No.:** **US D578,985 S**  
(45) **Date of Patent:** **\*\* Oct. 21, 2008**

(54) **MOBILE PHONE**

D555,132 S \* 11/2007 Kim et al. .... D14/138

(Continued)

(75) Inventors: **Kuk-Hwan Kim**, Seoul (KR); **Nam-Mi Kim**, Seoul (KR); **Chang-Soo Lee**, Incheon (KR)

(73) Assignee: **Samsung Electronics Co., Ltd.**, Suwon-si (KR)

(\*\*) Term: **14 Years**

(21) Appl. No.: **29/290,248**

(22) Filed: **Nov. 8, 2007**

(30) **Foreign Application Priority Data**

Aug. 10, 2007 (KR) ..... 30-2007-0034495

(51) **LOC (8) Cl.** ..... **14-03**

(52) **U.S. Cl.** ..... **D14/138**

(58) **Field of Classification Search** ..... D14/137, D14/138, 147, 218, 247-248, 341-347, 496; D10/65, 78, 104; D13/168; D18/7; 455/556.1, 455/566, 575.1, 575.3; 345/169  
See application file for complete search history.

(56) **References Cited**

**U.S. PATENT DOCUMENTS**

D502,703 S *	3/2005	Tsujimoto et al. ....	D14/346
D519,998 S *	5/2006	Park .....	D14/346
D527,000 S *	8/2006	Hong et al. ....	D14/346
D531,609 S *	11/2006	Kim et al. ....	D14/138
D531,977 S *	11/2006	Kim et al. ....	D14/138
D541,782 S *	5/2007	Kim et al. ....	D14/138
D543,176 S *	5/2007	Hyun et al. ....	D14/138
D544,460 S *	6/2007	Yau .....	D14/138
D545,291 S *	6/2007	Chuang .....	D14/138
D547,292 S *	7/2007	Kim et al. ....	D14/138
D548,213 S *	8/2007	Lee et al. ....	D14/138
D549,204 S *	8/2007	Cho .....	D14/138
D551,646 S *	9/2007	Kim et al. ....	D14/138
7,269,450 B2 *	9/2007	Lee et al. ....	455/575.1

**OTHER PUBLICATIONS**

LG V9000, announced Feb. 2006, [online], [retrieved on Feb. 20, 2007]. Retrieved from Internet ,<URL: http://www.gsmarena.com>.\*

LG U900, announced Apr. 2006, [online], [retrieved on Feb. 20, 2007]. Retrieved from Internet ,<URL: http://www.gsmarena.com>.\*

LG KU950, announced Feb. 2007, [online], [retrieved on Feb. 20, 2007]. Retrieved from Internet ,<URL: http://www.gsmarena.com>.\*

LG U960, announced 3<sup>rd</sup> quarter 2007, [online], [retrieved on Dec. 13, 2007]. Retrieved from Internet ,<URL: http://www.gsmarena.com>.\*

Samsung P930, announced Dec. 2006, [online], [retrieved on Feb. 8, 2007]. Retrieved from Internet ,<URL: http://www.gsmarena.com>.\*

*Primary Examiner*—Jeffrey D. Asch

*Assistant Examiner*—Bridget L Eland

(74) *Attorney, Agent, or Firm*—Staas & Halsey LLP

(57) **CLAIM**

The ornamental design for a mobile phone, as shown and described.

**DESCRIPTION**

FIG. 1 is a perspective view of a mobile phone;  
FIG. 2 is a front view of the mobile phone of FIG. 1;  
FIG. 3 is a rear view of the mobile phone of FIG. 1;  
FIG. 4 is left-side of the mobile phone of FIG. 1;  
FIG. 5 is right-side of the mobile phone of FIG. 1;  
FIG. 6 is top plan view of the mobile phone of FIG. 1;  
FIG. 7 is bottom plan view of the mobile phone of FIG. 1;  
FIG. 8 is an open perspective view of the mobile phone of FIG. 1; and,  
FIG. 9 is another open perspective view of the mobile phone of FIG. 1, where the display portion is horizontally rotated.

**1 Claim, 7 Drawing Sheets**

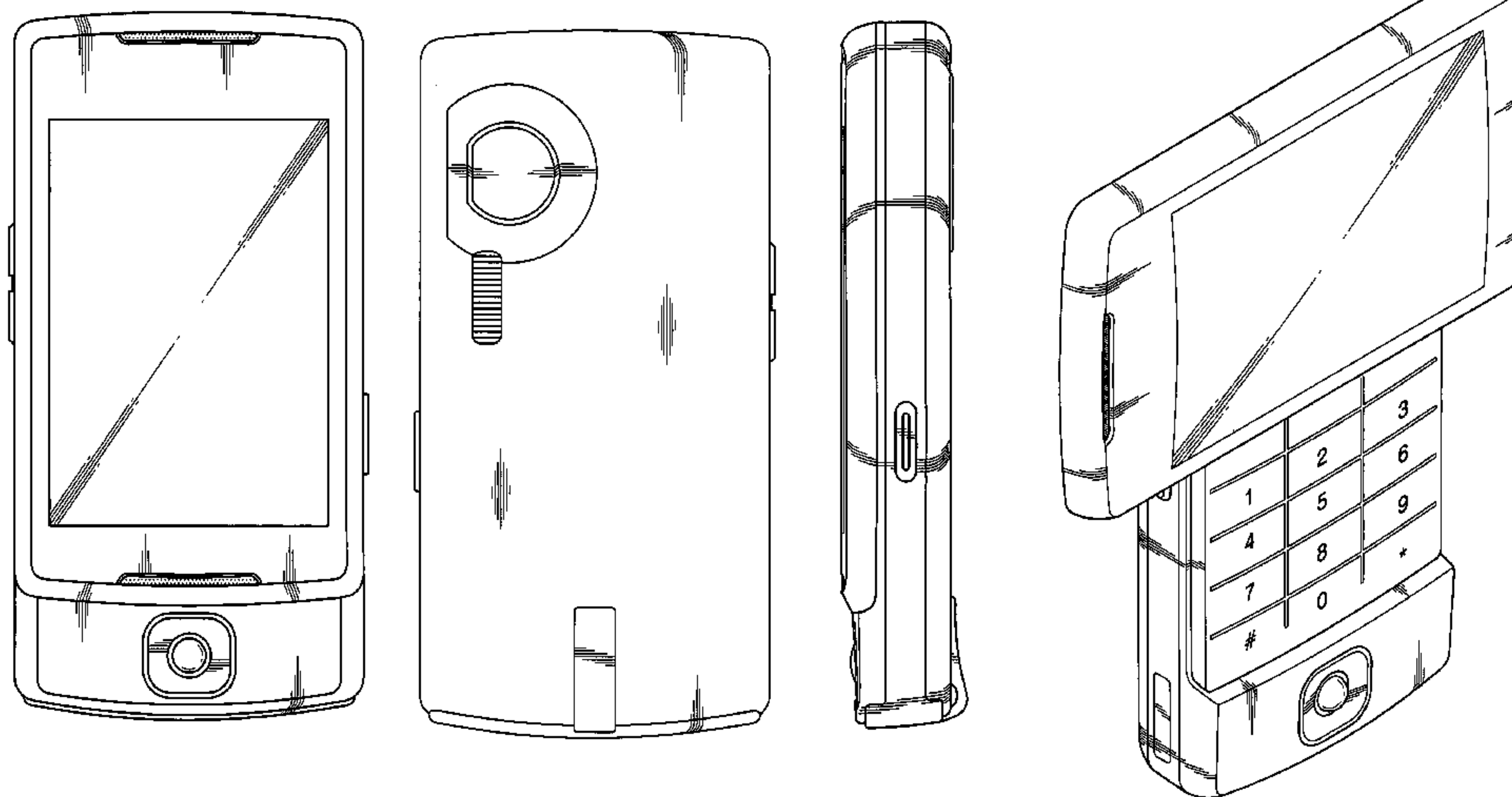

# US D578,985 S

Page 2

---

## U.S. PATENT DOCUMENTS

D555,623 S *	11/2007	Cho et al. ....	D14/138	D567,819 S *	4/2008	Devericks et al. ....	D14/496
D560,193 S *	1/2008	Sung et al. ....	D14/138	D568,286 S *	5/2008	Suk et al. ....	D14/138
D562,290 S *	2/2008	Cho et al. ....	D14/138	D569,365 S *	5/2008	Shin et al. ....	D14/138
D563,369 S *	3/2008	Kim et al. ....	D14/138	7,369,882 B2 *	5/2008	Hwang et al. ....	455/575.1
D563,936 S *	3/2008	Kim et al. ....	D14/138	2007/0103443 A1 *	5/2007	Park et al. ....	345/169
				2007/0123309 A1 *	5/2007	Sano et al. ....	455/566

\* cited by examiner

FIG. 1

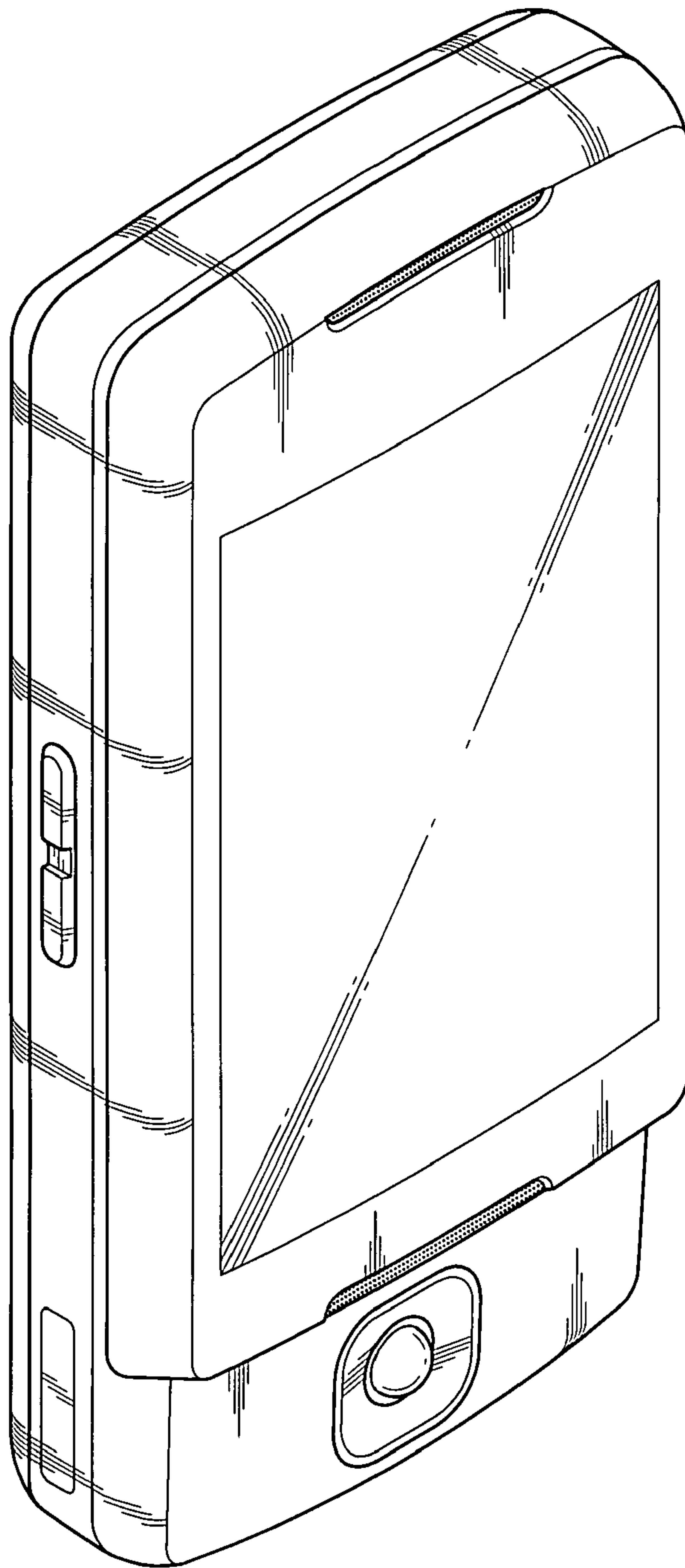

FIG. 2

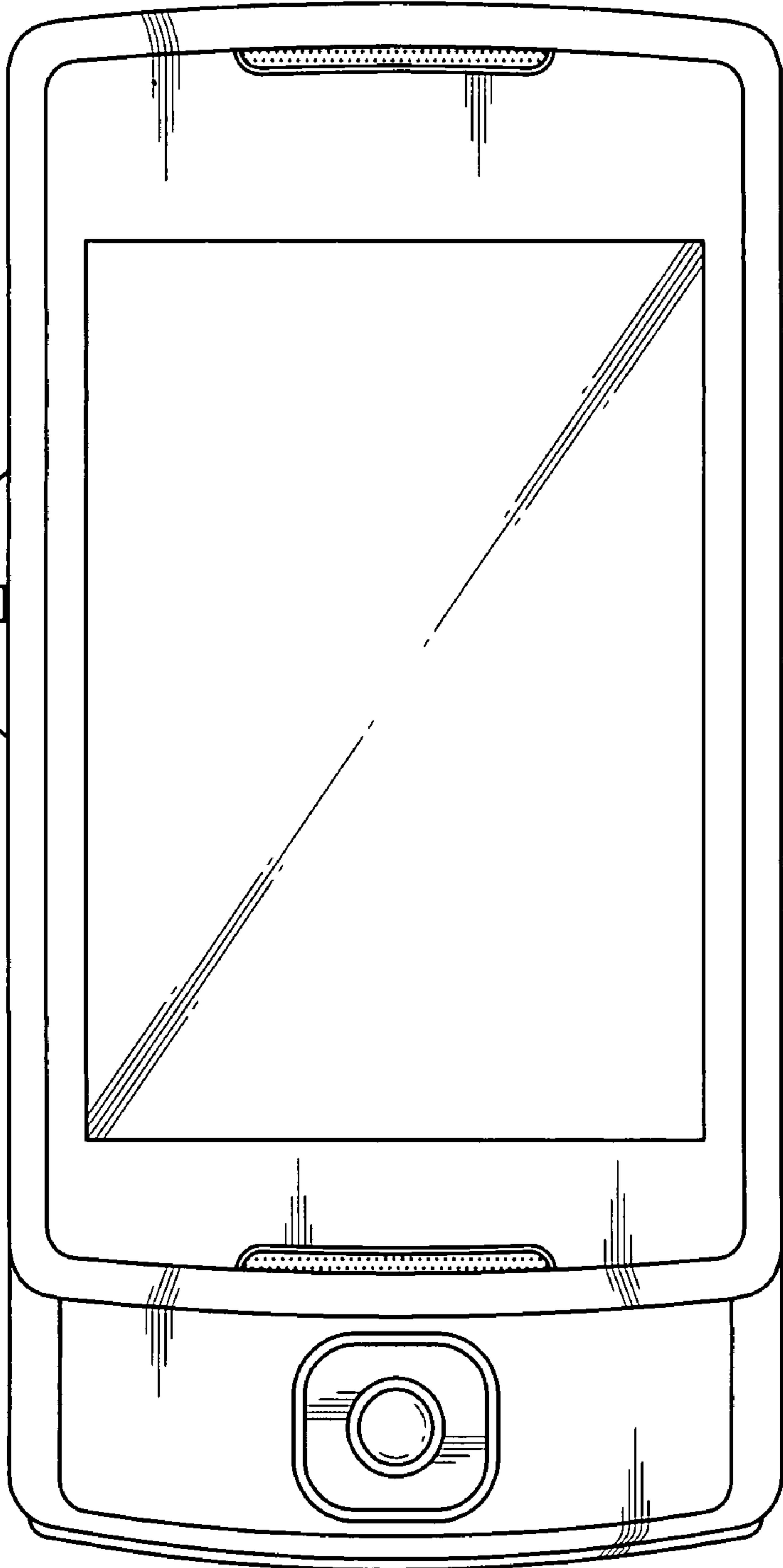

FIG. 3

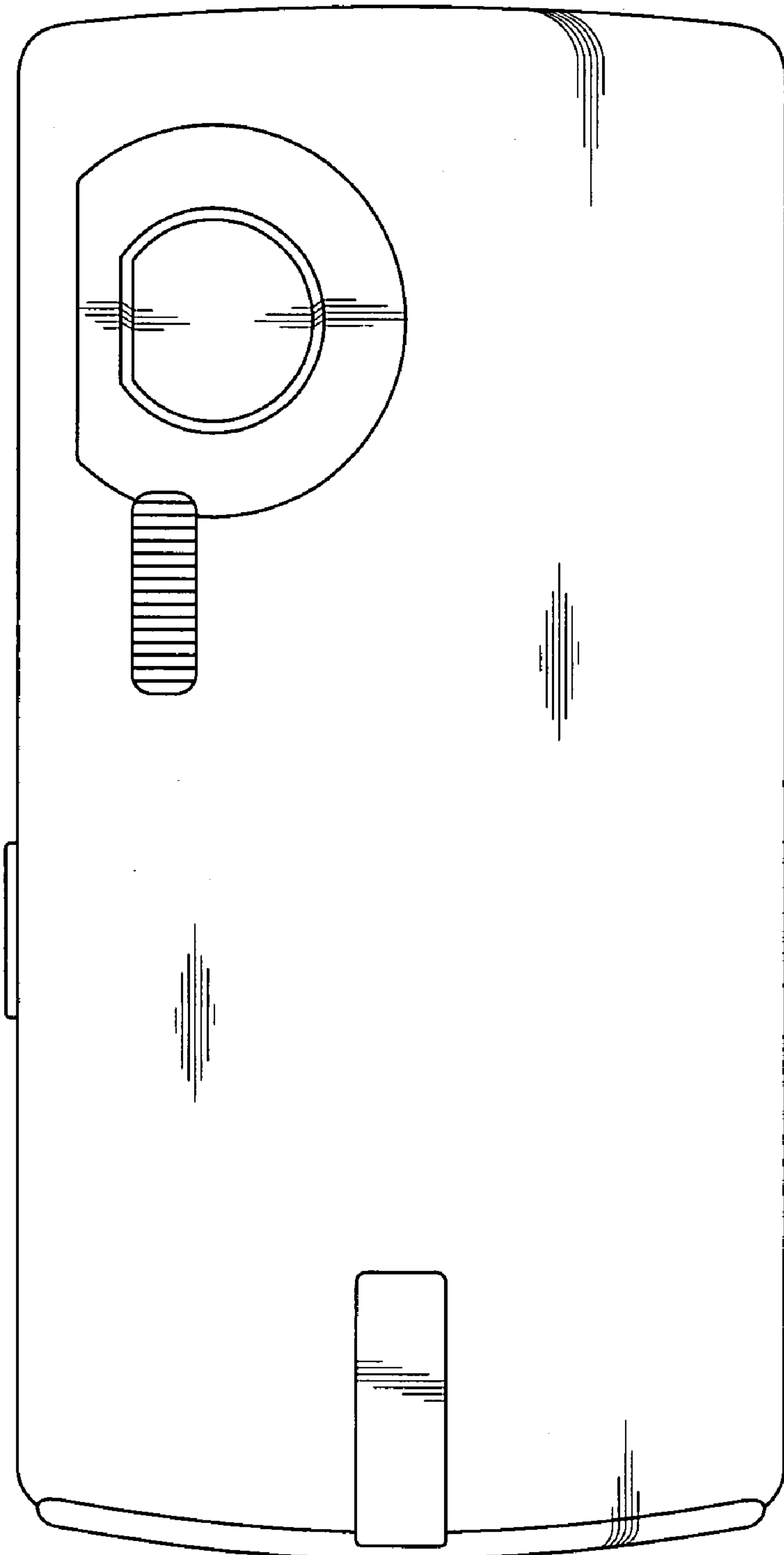

FIG. 4

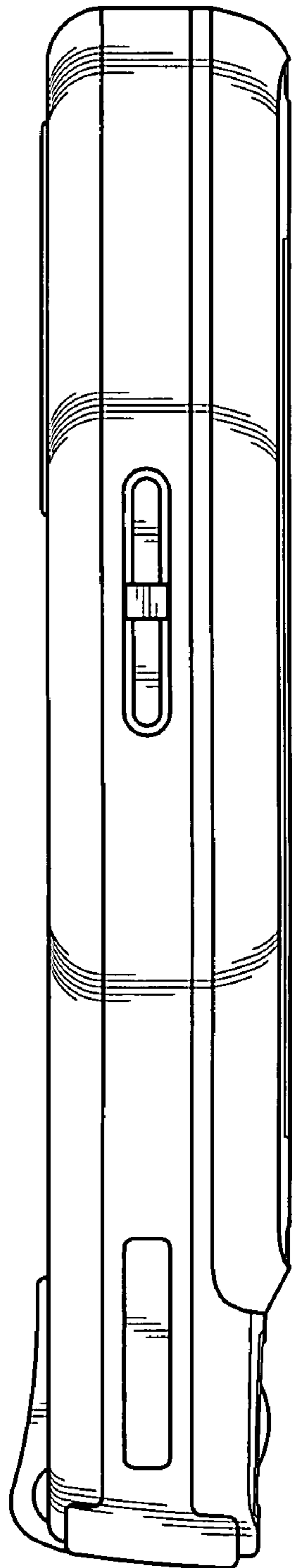

FIG. 5

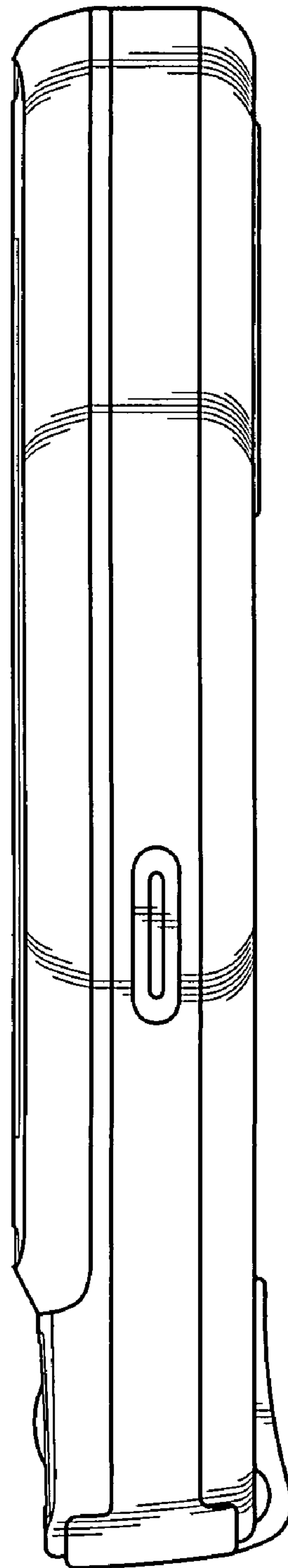

FIG. 6

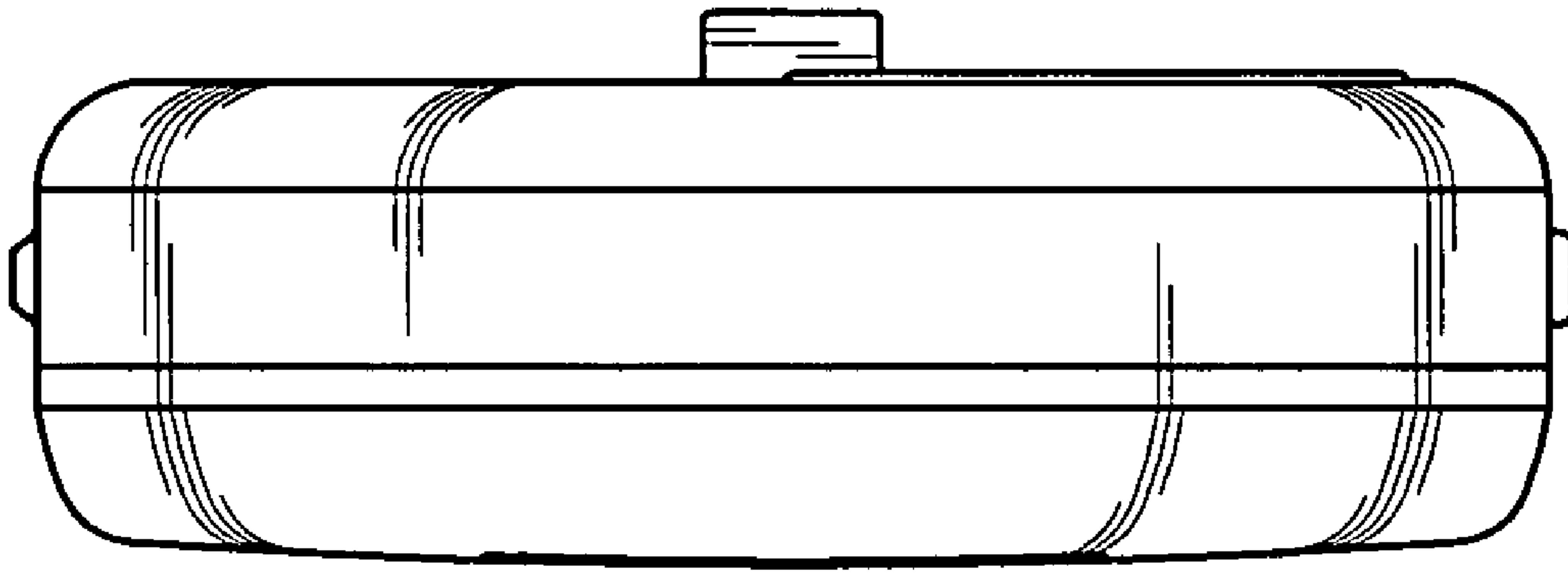

FIG. 7

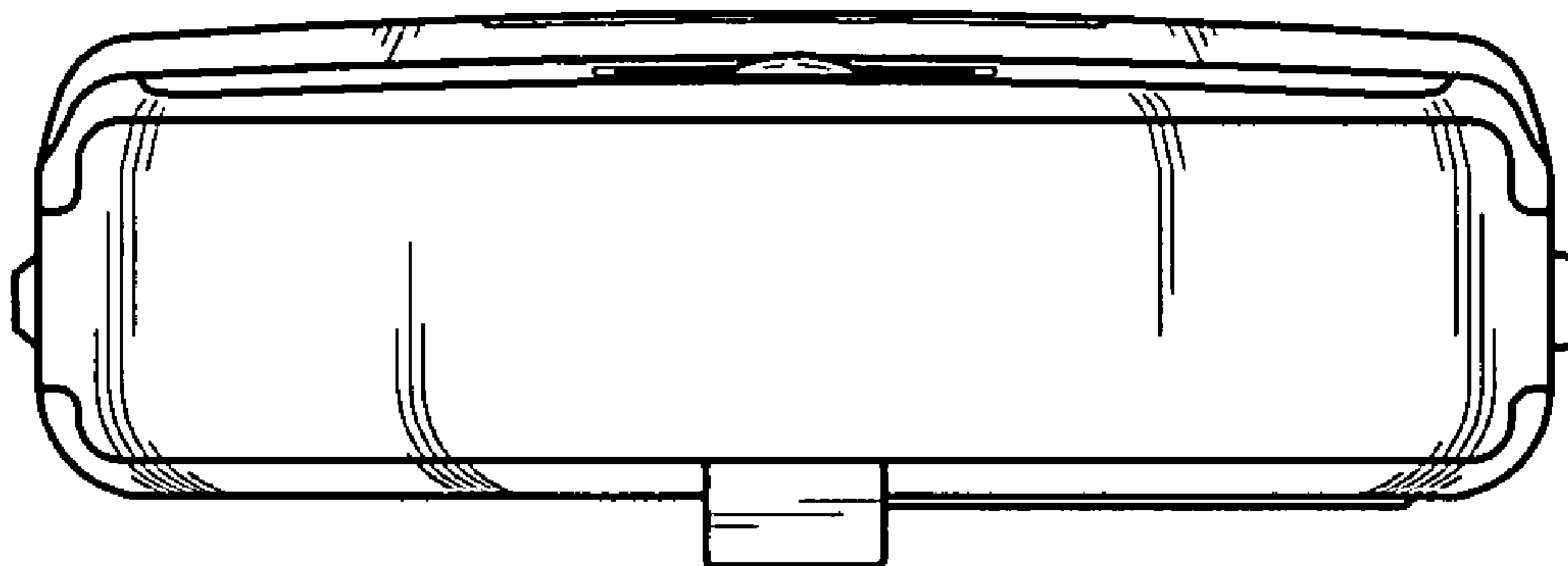



FIG. 8

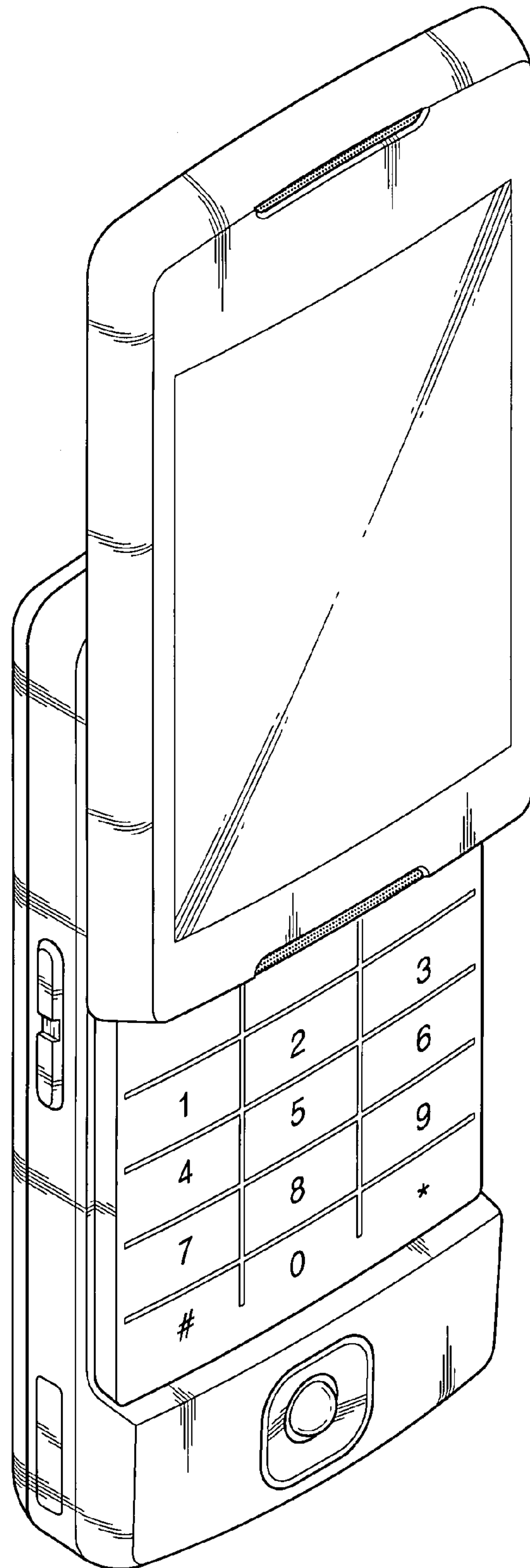



FIG. 9

