



US00D578977S

(12) **United States Design Patent**
Kim et al.

(10) **Patent No.:** **US D578,977 S**
(45) **Date of Patent:** **** Oct. 21, 2008**

(54) **MOBILE PHONE**

(75) Inventors: **Kuk-Hwan Kim**, Seoul (KR); **Nam-Mi Kim**, Seoul (KR); **Chang-Hwan Hwang**, Goyang-si (KR)

(73) Assignee: **Samsung Electronics Co., Ltd.**, Suwon-Si (KR)

(**) Term: **14 Years**

(21) Appl. No.: **29/272,154**

(22) Filed: **Feb. 2, 2007**

(30) **Foreign Application Priority Data**

Nov. 30, 2006 (KR) 30-2006-0047571

(51) **LOC (8) Cl.** **14-03**

(52) **U.S. Cl.** **D14/138**

(58) **Field of Classification Search** D14/138,
D14/496, 341-347; 455/575.3, 575.1
See application file for complete search history.

(56) **References Cited**

U.S. PATENT DOCUMENTS

D505,124 S *	5/2005	Takada	D14/138
D506,454 S *	6/2005	Kim et al.	D14/138
D508,034 S *	8/2005	Liao	D14/138
D508,476 S *	8/2005	Kim	D14/138
D510,078 S *	9/2005	Lee et al.	D14/138
D520,978 S *	5/2006	Lee	D14/138
D536,686 S *	2/2007	Miyata	D14/138
D537,061 S *	2/2007	Oh	D14/138
D546,310 S *	7/2007	Lee	D14/138
D551,639 S *	9/2007	Kim	D14/138
D552,577 S *	10/2007	Kim et al.	D14/138
D556,721 S *	12/2007	Lee	D14/138
D563,349 S *	3/2008	Kim et al.	D14/138

(Continued)

OTHER PUBLICATIONS

VK Mobile VK540 telephone, announced 2nd quarter 2004, [online], [site visited Jun. 20, 2008]. Available from Internet ,<URL: http://www.gsmarena.com>.*

Bird M08 telephone, announced 3rd quarter 2005, [online], [site visited Jun. 20, 2008]. Available from Internet ,<URL: http://www.gsmarena.com>.*

Samsung E780 telephone, announced 1st quarter 2006, [online], [site visited Jun. 20, 2008]. Available from Internet ,<URL: http://www.gsmarena.com>.*

Samsung ZV40 telephone, announced Jul. 2006, [online], [site visited Jun. 20, 2008]. Available from Internet ,<URL: http://www.gsmarena.com>.*

Samsung i250 telephone, announced Mar. 2004, [online], [site visited Jun. 20, 2008]. Available from Internet ,<URL: http://www.gsmarena.com>.*

VK Mobile VK3100 telephone, announced 4th quarter 2005, [online], [site visited Jun. 20, 2008]. Available from Internet ,<URL: http://www.gsmarena.com>.*

Primary Examiner—Jeffrey D Asch

(74) *Attorney, Agent, or Firm*—Staas & Halsey LLP

(57) **CLAIM**

The ornamental design for the mobile phone, as shown and described.

DESCRIPTION

FIG. 1 is a perspective view of a mobile phone;
FIG. 2 is a front view of the mobile phone of FIG. 1;
FIG. 3 is a rear view of the mobile phone of FIG. 1;
FIG. 4 is a left-side view of the mobile phone of FIG. 1;
FIG. 5 is a right-side view of the mobile phone of FIG. 1;
FIG. 6 is a top plan view of the mobile phone of FIG. 1;
FIG. 7 is a bottom plan view of the mobile phone of FIG. 1;
and,
FIG. 8 is an open perspective view of the mobile phone of FIG. 1.

1 Claim, 5 Drawing Sheets

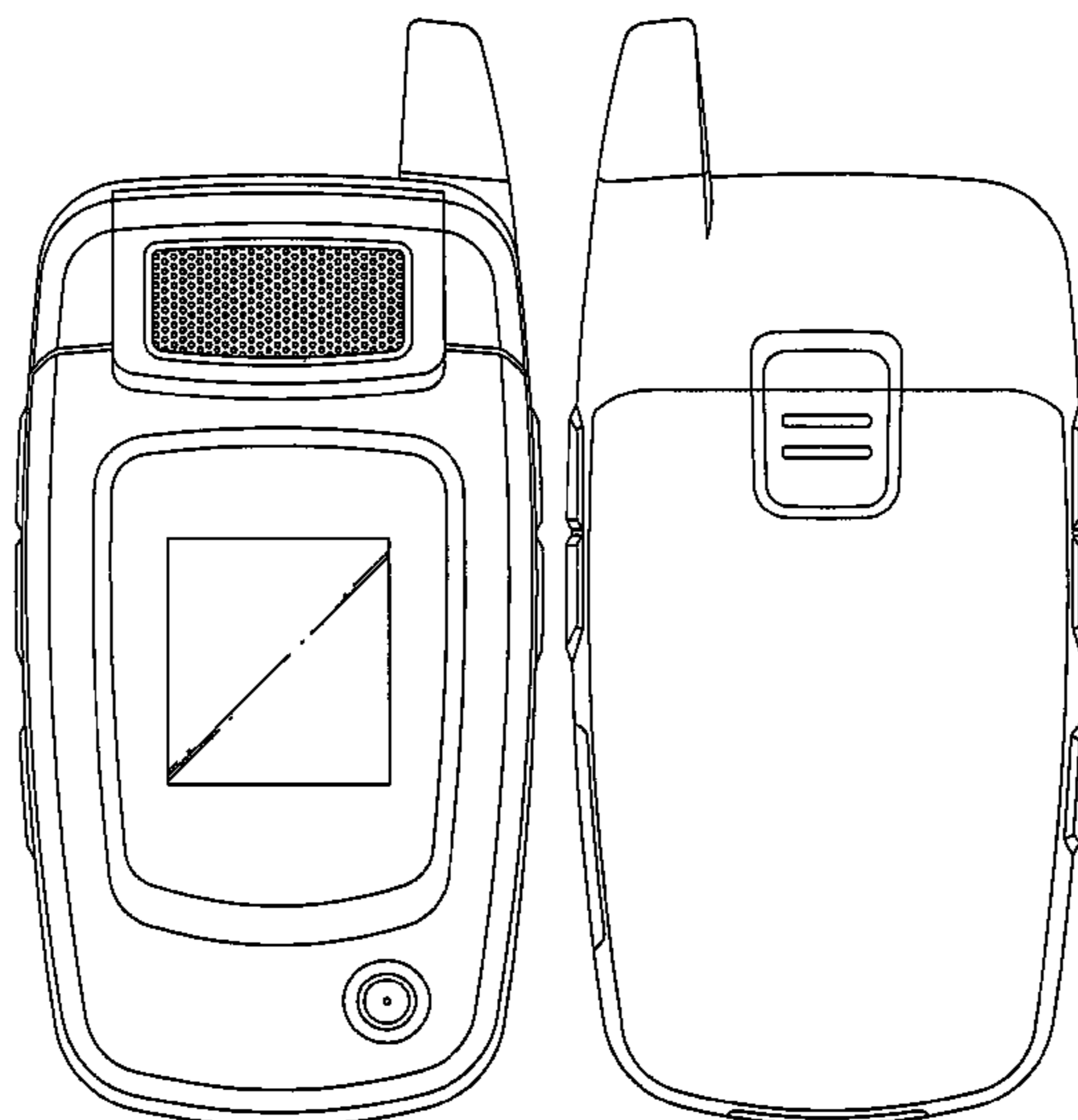

US D578,977 S

Page 2

U.S. PATENT DOCUMENTS

D563,360 S *	3/2008	Baik et al.	D14/138	D565,012 S *	3/2008	Lee et al.	D14/138
D563,361 S *	3/2008	Moon et al.	D14/138	D569,359 S *	5/2008	Park et al.	D14/138
D563,930 S *	3/2008	Kim et al.	D14/138	D569,361 S *	5/2008	Park	D14/138
D563,932 S *	3/2008	Song et al.	D14/138	D569,832 S *	5/2008	Lee et al.	D14/138
D564,487 S *	3/2008	Kim et al.	D14/138	D570,811 S *	6/2008	Lee et al.	D14/138
D565,008 S *	3/2008	Han et al.	D14/138	D571,335 S *	6/2008	Lee et al.	D14/138
				D571,336 S *	6/2008	Lee et al.	D14/138

* cited by examiner

FIG. 1

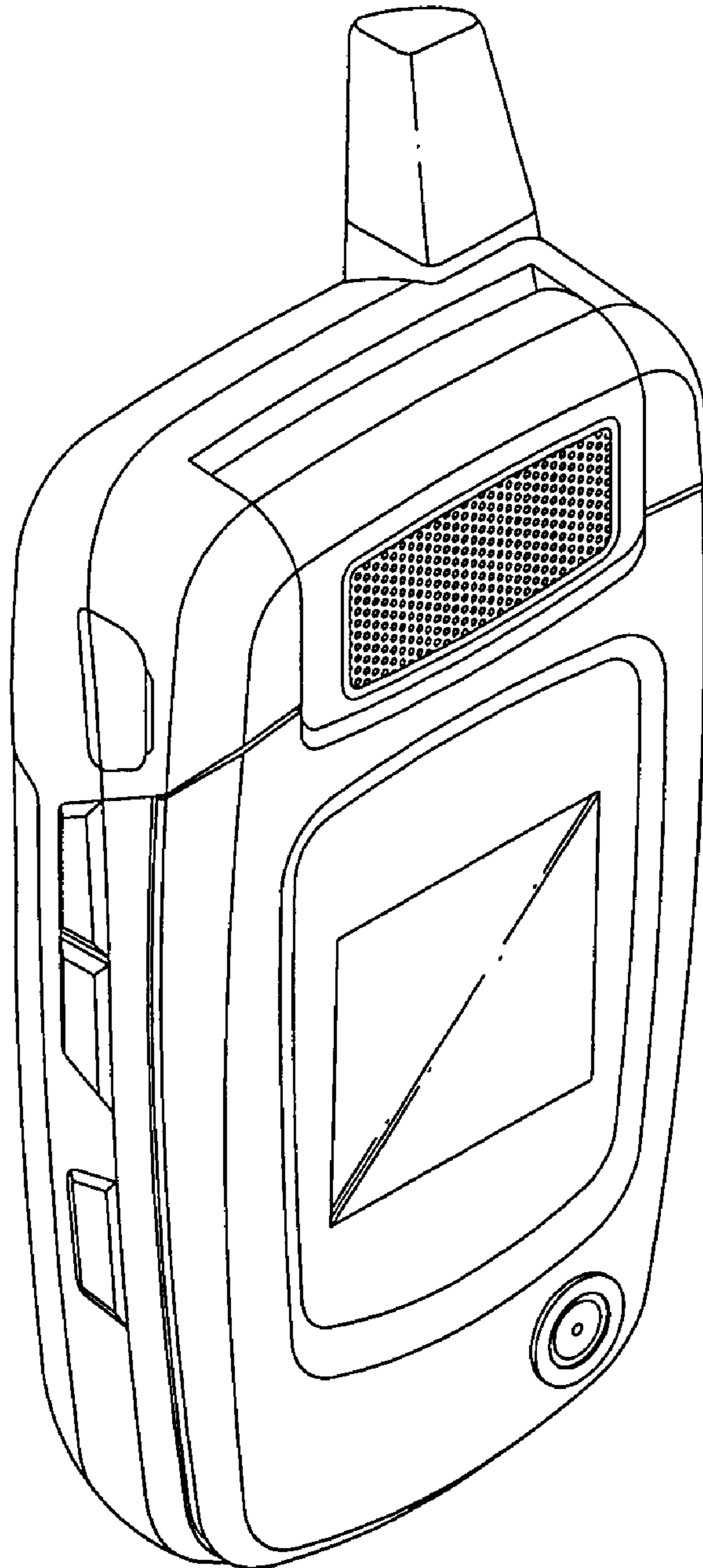

FIG. 2

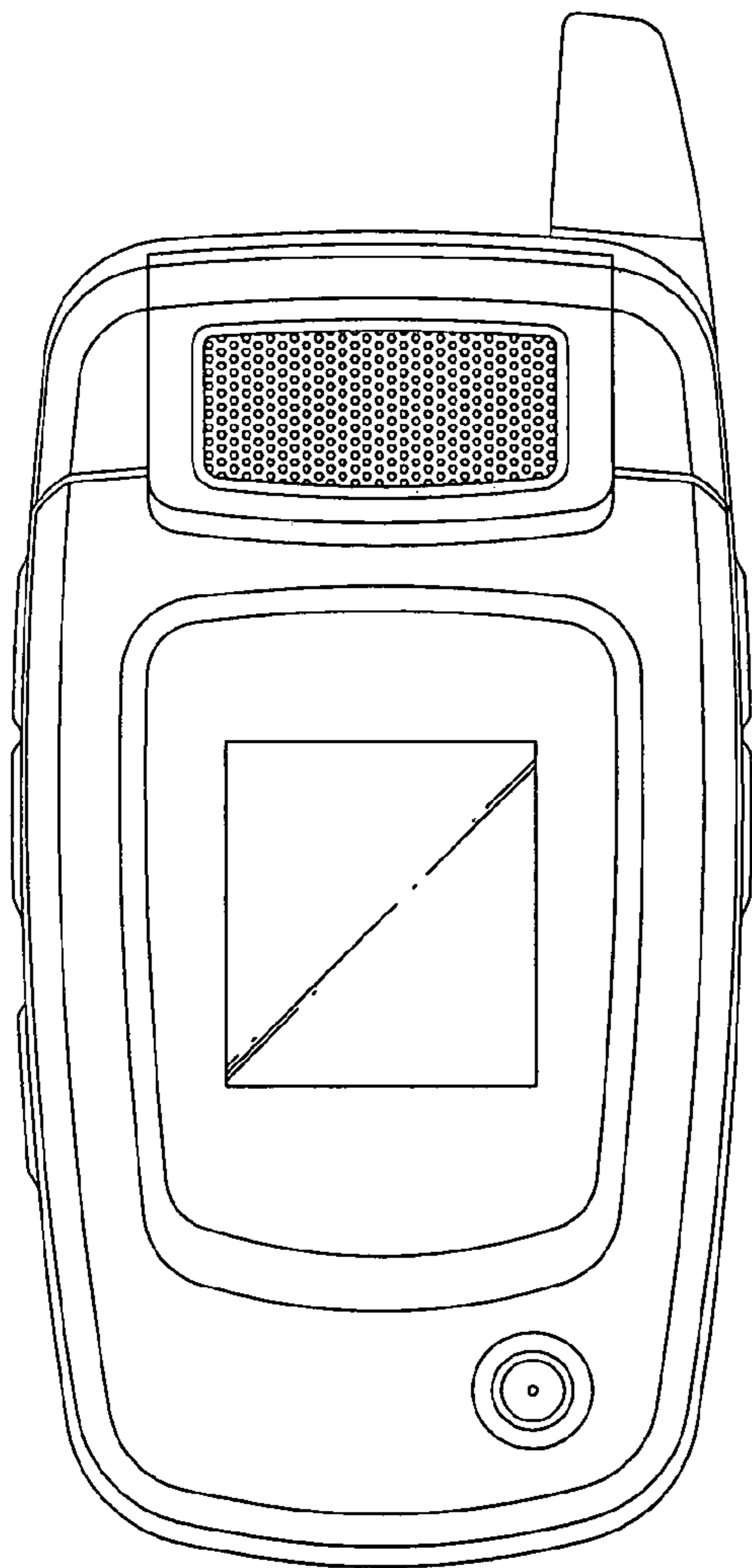

FIG. 3

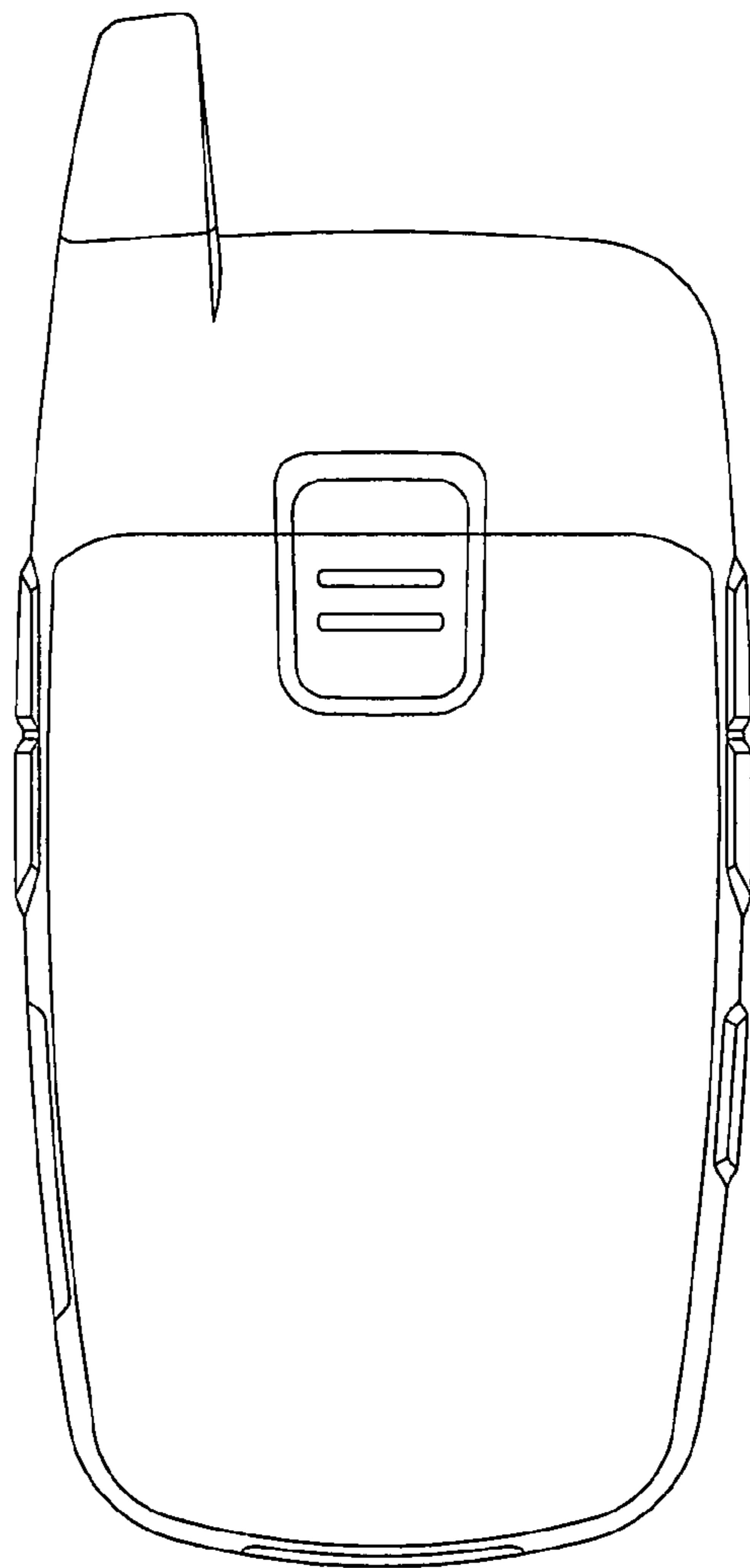

FIG. 4

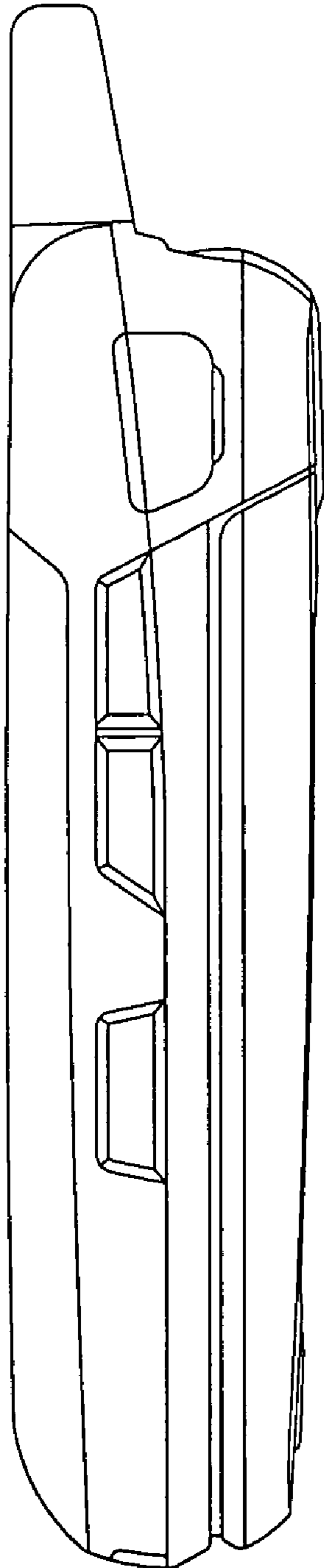

FIG. 5

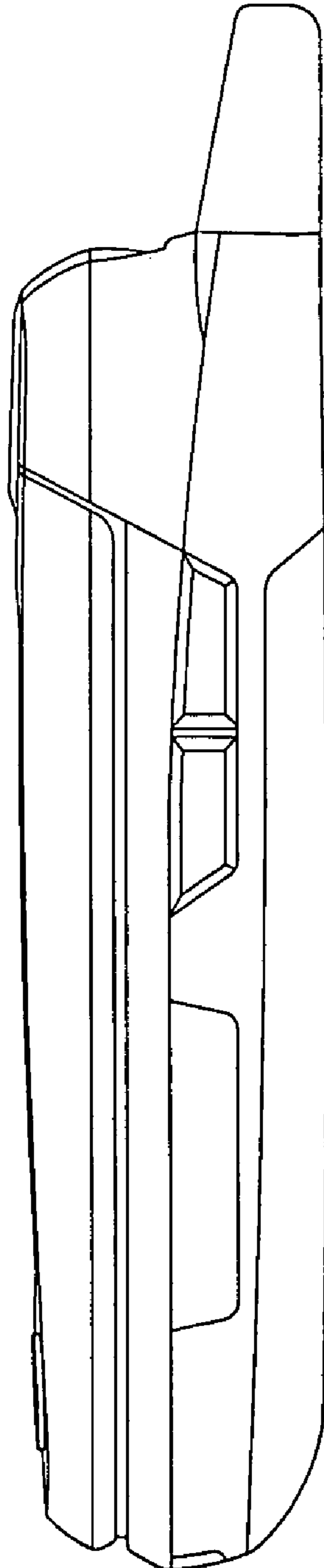

FIG. 6

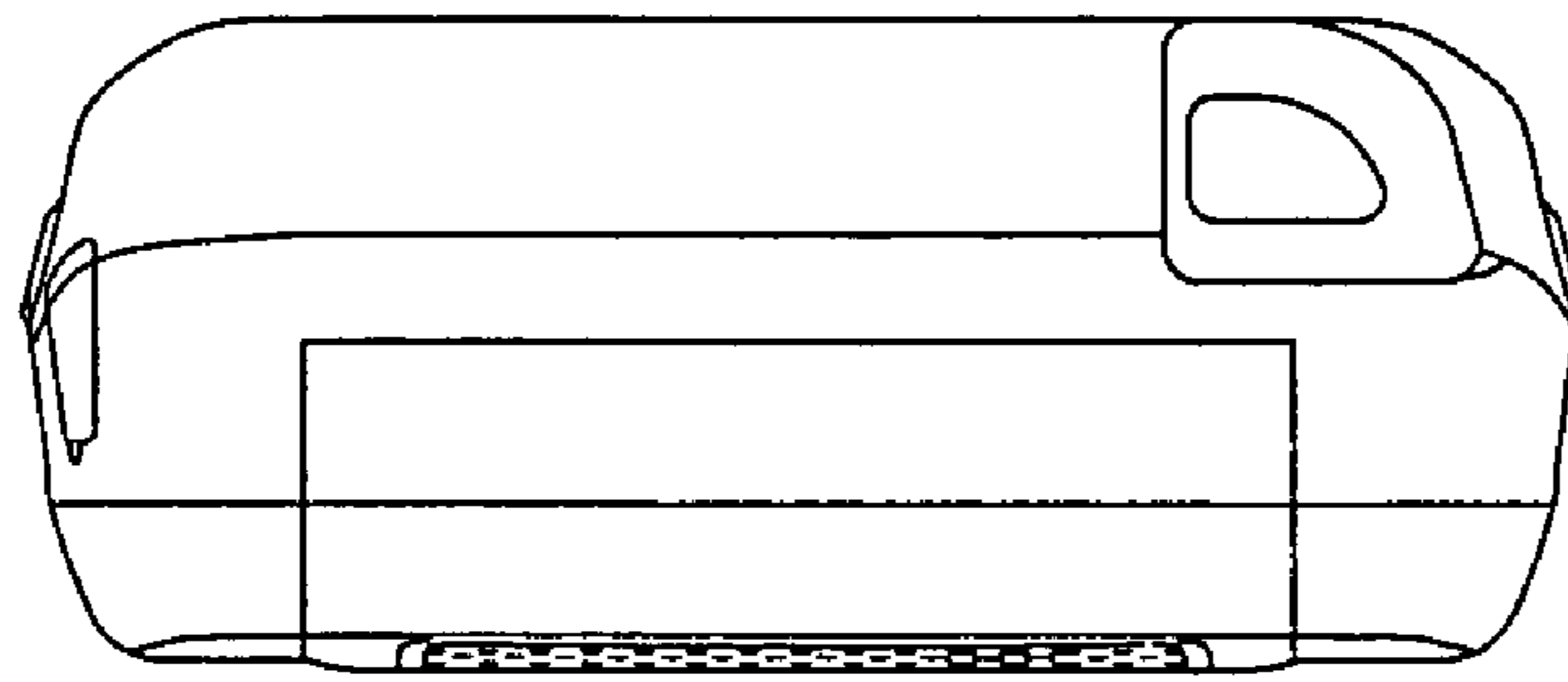

FIG. 7

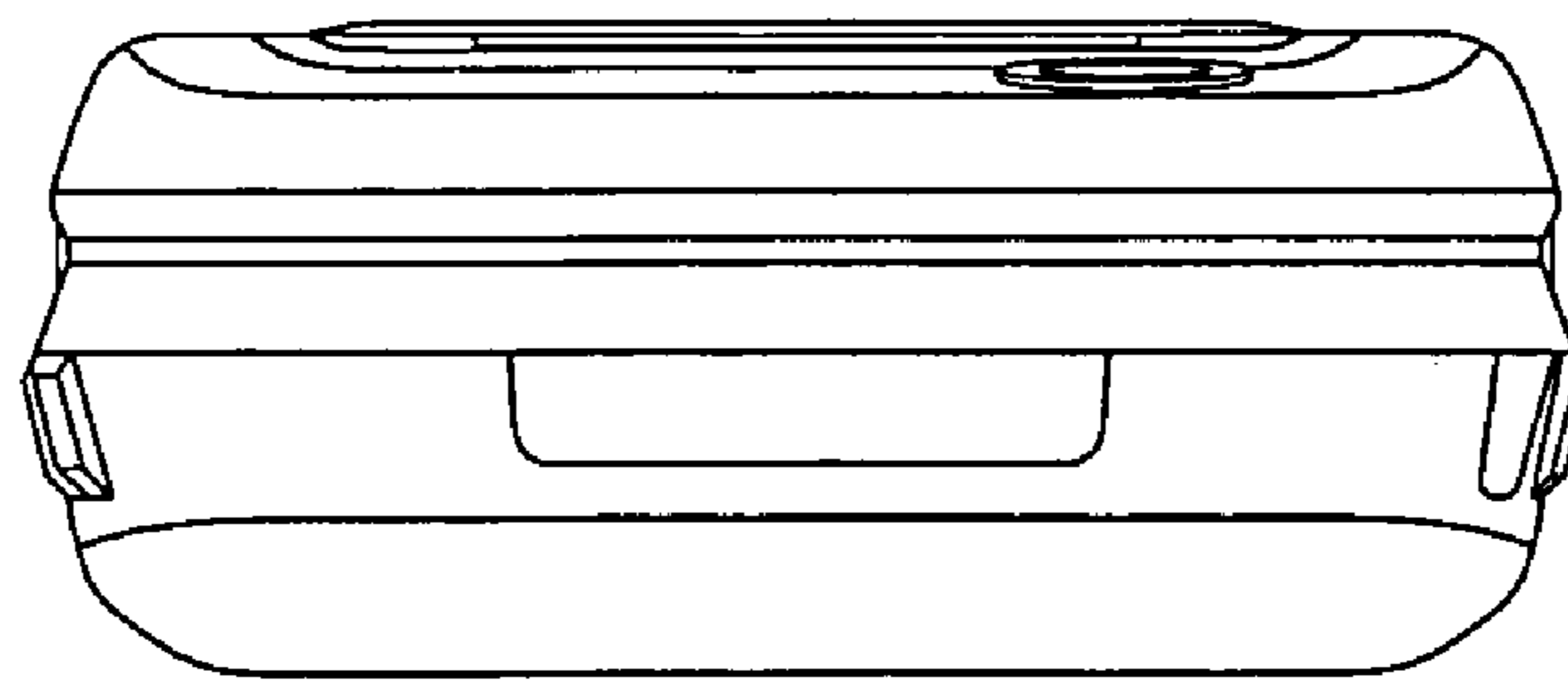

FIG. 8

