



US00D578883S

(12) **United States Design Patent**  
**Kisch**

(10) **Patent No.:** **US D578,883 S**  
(45) **Date of Patent:** **\*\* Oct. 21, 2008**

(54) **TRIANGULAR COLUMN BOX WITH  
EXTENDED LID DIVIDER**

(76) Inventor: **Raymond G. M. Kisch**, 2170 Academy  
Ave., Sanger, CA (US) 93657

(\*\*) Term: **14 Years**

(21) Appl. No.: **29/285,308**

(22) Filed: **Mar. 27, 2007**

(51) **LOC (8) Cl.** ..... **09-03**

(52) **U.S. Cl.** ..... **D9/432**

(58) **Field of Classification Search** ..... D9/430-433,  
D9/414-418, 420-429, 560, 737, 756, 631,  
D9/636, 640, 642; D3/273, 302, 304, 305,  
D3/307, 309-312, 314, 317, 318, 901, 905;  
206/421, 454, 457, 775-778, 784, 822; 220/500,  
220/523-529, 552, 555; 229/100, 103.3,  
229/104-106, 108, 108.1, 109, 110, 111,  
229/112, 117.09, 117.12, 117.15, 120, 125.015,  
229/160.1, 162.1, 182.1, 215, 247, 406, 407,  
229/902, 920, 922, 930, 942; D2/731, 748;  
D6/396, 407, 629, 633

See application file for complete search history.

(56) **References Cited**

**U.S. PATENT DOCUMENTS**

1,697,709 A \* 1/1929 Bliss ..... 229/122.26  
2,742,221 A \* 4/1956 Hickin ..... 229/174  
3,170,616 A \* 2/1965 Crozier ..... 206/199  
3,670,949 A \* 6/1972 Galanes ..... 229/120  
3,899,123 A \* 8/1975 Stollberg et al. .... 229/117.08  
4,304,351 A \* 12/1981 Stollberg ..... 229/122.24  
4,304,353 A \* 12/1981 Stollberg ..... 229/126  
4,389,013 A \* 6/1983 Hall et al. .... 206/509  
4,396,145 A \* 8/1983 Ditton ..... 229/120.17  
4,613,045 A \* 9/1986 Watson ..... 206/512  
4,709,852 A \* 12/1987 Stoll ..... 229/119  
D307,109 S \* 4/1990 Dasher et al. .... D9/418  
4,948,033 A \* 8/1990 Halsell et al. .... 229/122.33  
5,125,568 A \* 6/1992 Bauer ..... 229/172  
D348,607 S \* 7/1994 Young ..... D9/423

5,333,777 A \* 8/1994 Roth ..... 229/117.16  
5,335,844 A \* 8/1994 Young ..... 229/122.26  
5,390,847 A \* 2/1995 Young ..... 229/122.21  
D369,104 S \* 4/1996 Heiskell et al. .... D9/431  
5,535,941 A \* 7/1996 Garza ..... 229/191  
6,098,873 A \* 8/2000 Sheffer ..... 229/178  
6,311,891 B1 11/2001 Gardner  
6,719,191 B1 4/2004 Christensen et al.  
6,889,893 B2 \* 5/2005 Kent ..... 229/171  
7,255,262 B2 \* 8/2007 Duyst ..... 229/120.17  
D552,988 S \* 10/2007 Kisch ..... D9/432

(Continued)

**FOREIGN PATENT DOCUMENTS**

WO WO 3022692 A1 \* 9/2002  
WO WO 3072444 A1 \* 9/2003

*Primary Examiner*—T. Chase Nelson  
*Assistant Examiner*—Karen Acker  
(74) *Attorney, Agent, or Firm*—Richard A. Ryan

(57) **CLAIM**

The ornamental design for a triangular column box with extended lid divider, as shown and described.

**DESCRIPTION**

FIG. 1 is a perspective view of the triangular column box with extended lid divider of the present invention shown with the lid closed and the divider panels disposed inside the box between the columns;

FIG. 2 is a perspective view of FIG. 1 with the lid open to show the divider panels connected to the lid flaps, which are attached to the left and right side panels;

FIG. 3 is a top plan view of FIG. 1;

FIG. 4 is a right side elevational view of FIG. 1, the left side elevational view being a mirror image thereof;

FIG. 5 is a bottom plan view of FIG. 1; and,

FIG. 6 is a front elevational view of FIG. 1, the rear elevational view being a mirror image thereof.

**1 Claim, 3 Drawing Sheets**

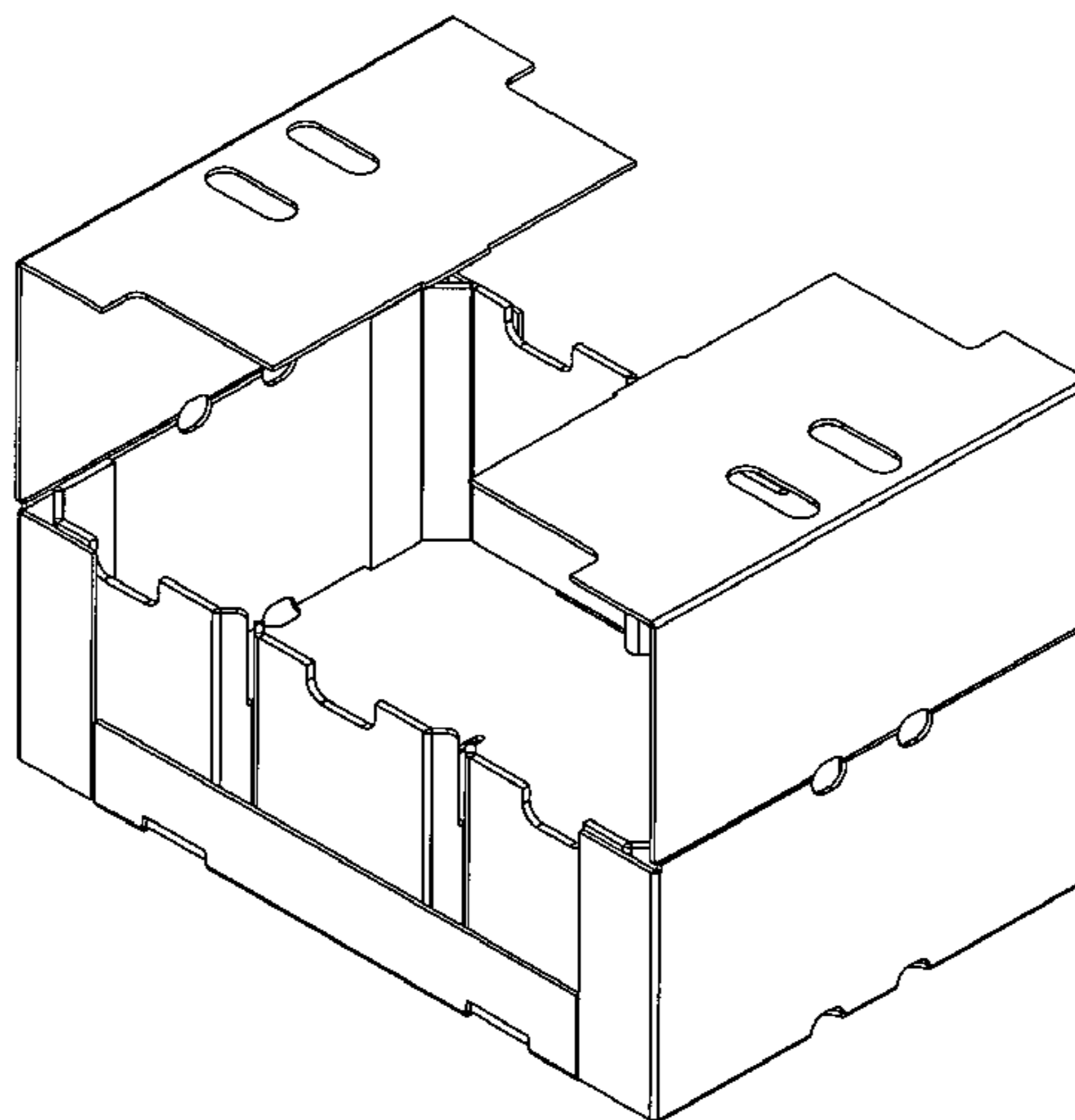

# US D578,883 S

Page 2

---

## U.S. PATENT DOCUMENTS

2003/0047592	A1 *	3/2003	Quaintance	.....	229/109	2004/0211824	A1 *	10/2004	Conway	.....	229/167
2003/0168502	A1 *	9/2003	Kisch	.....	229/120.34	2006/0213958	A1 *	9/2006	Valenzuela et al.	.....	229/120
2004/0007613	A1 *	1/2004	Quaintance	.....	229/177	2006/0283926	A1 *	12/2006	Durnin	.....	229/120.32
						2008/0110964	A1 *	5/2008	Churvis	.....	229/100

\* cited by examiner

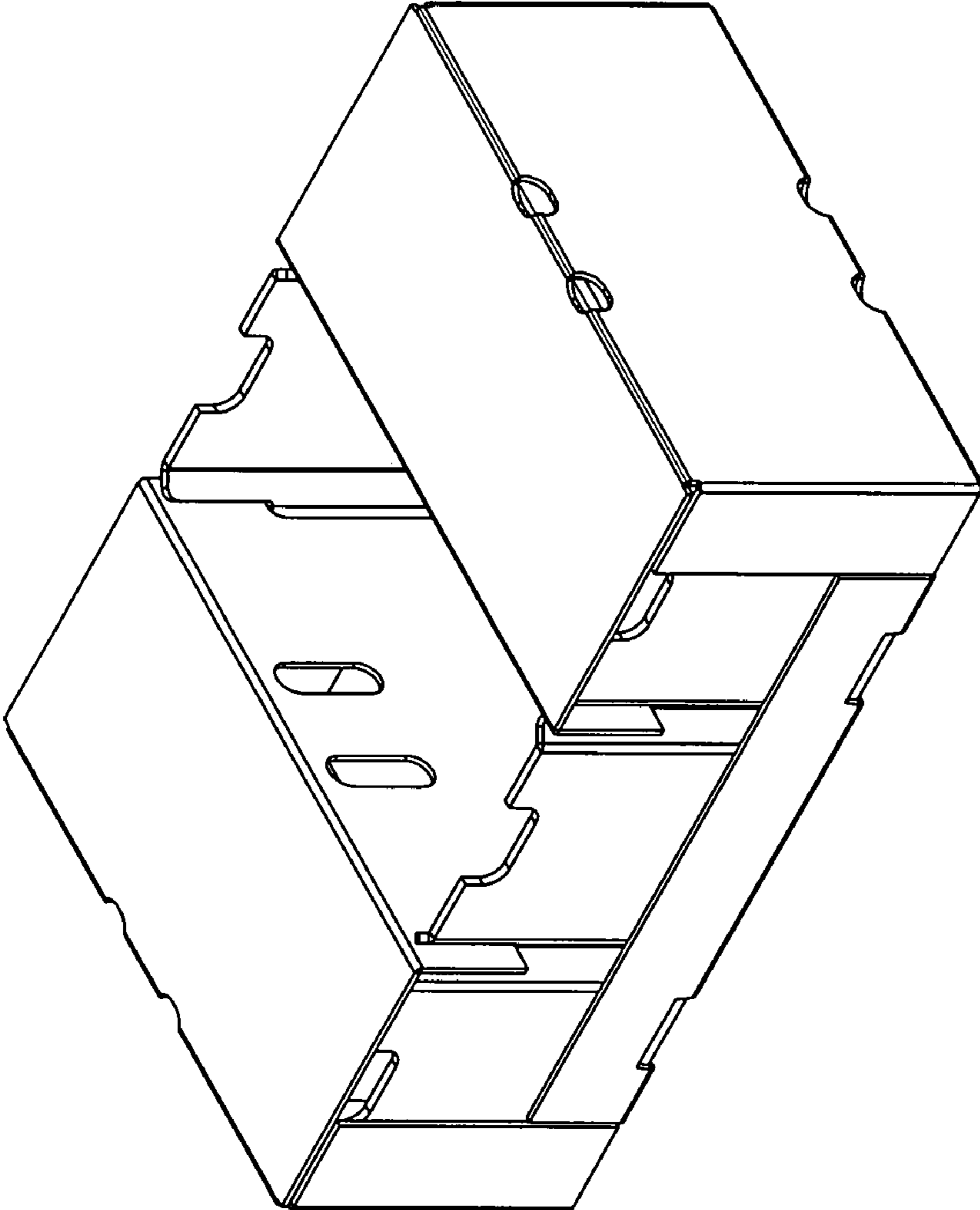

FIGURE 1

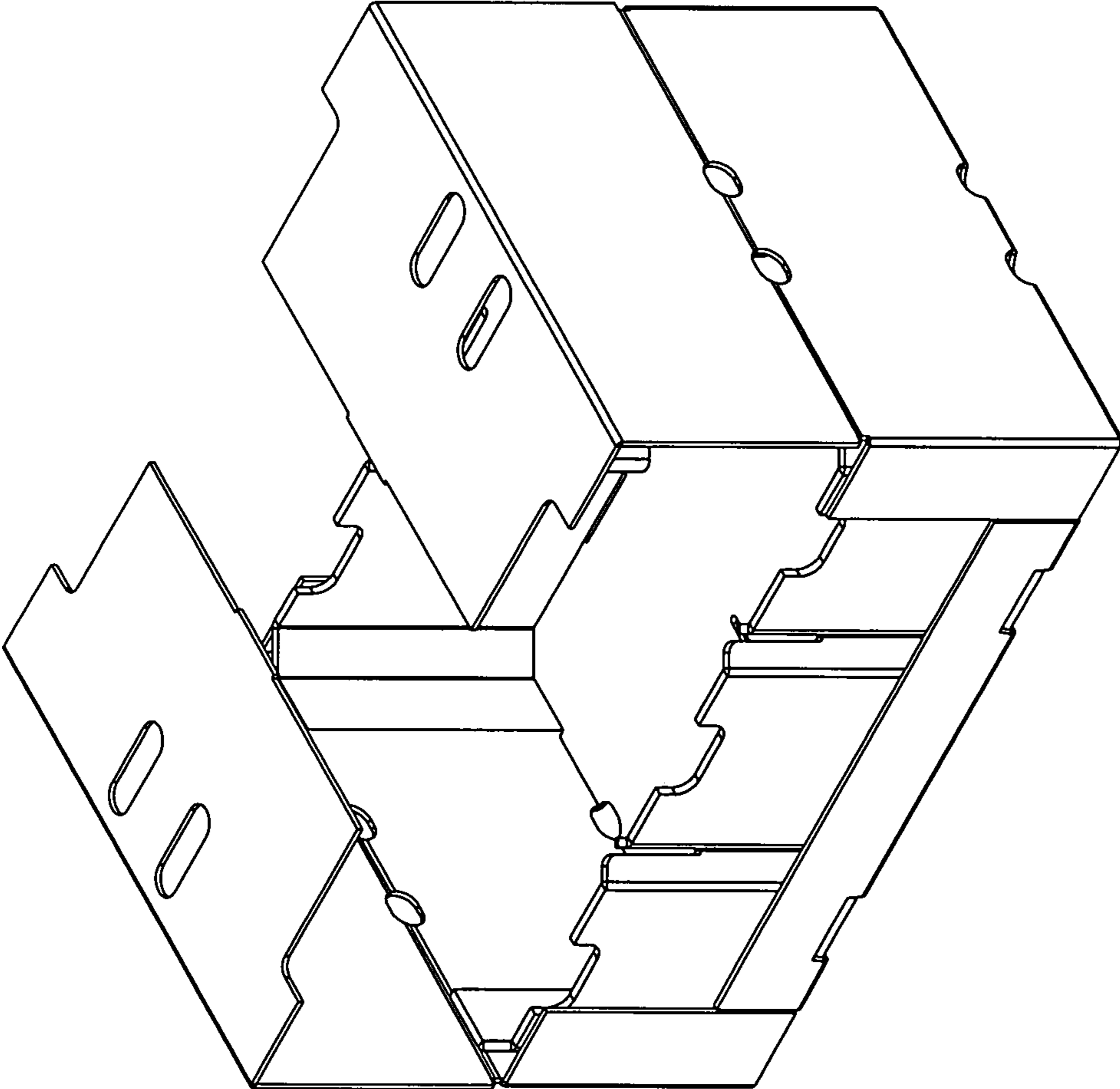

FIGURE 2

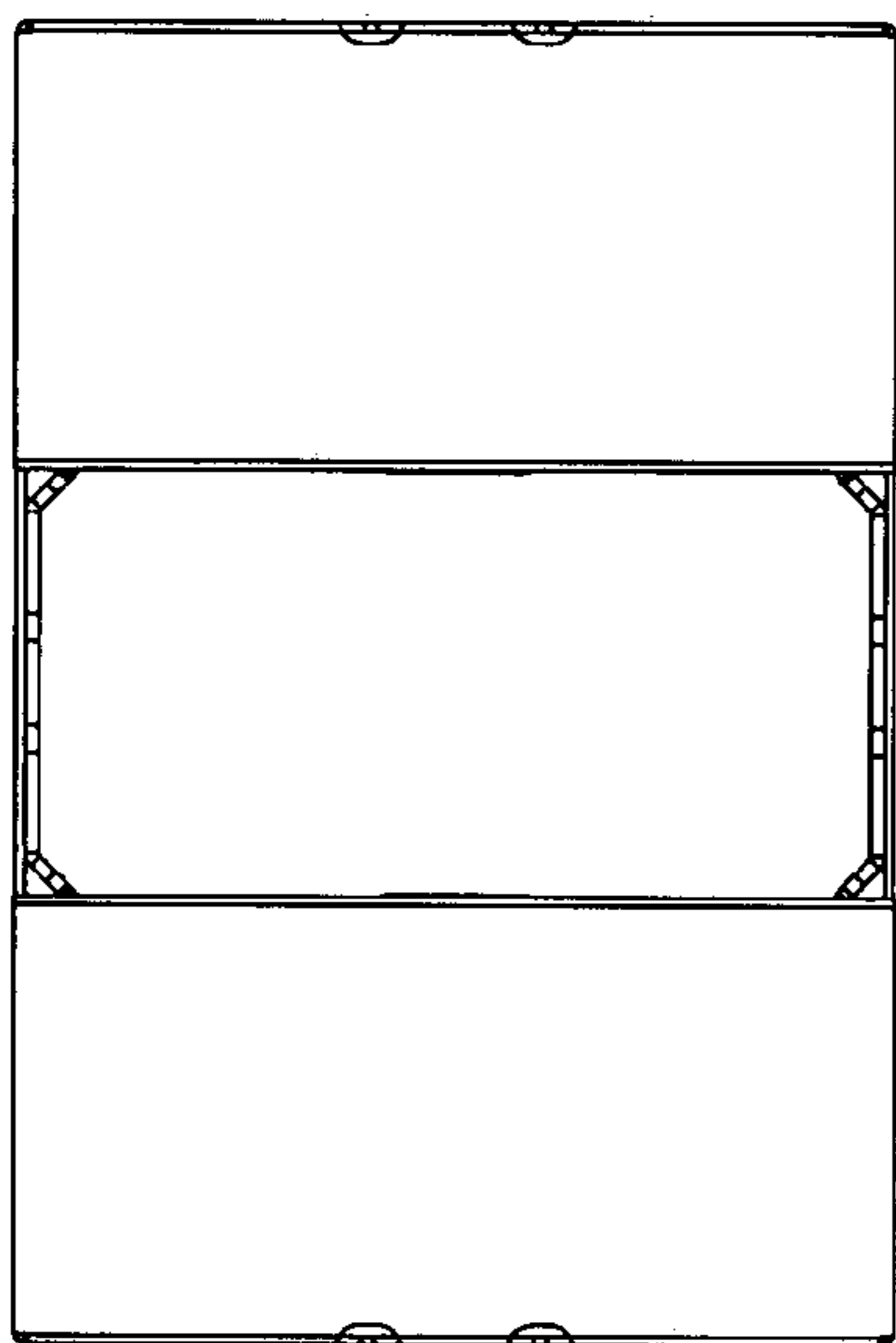

FIGURE 3

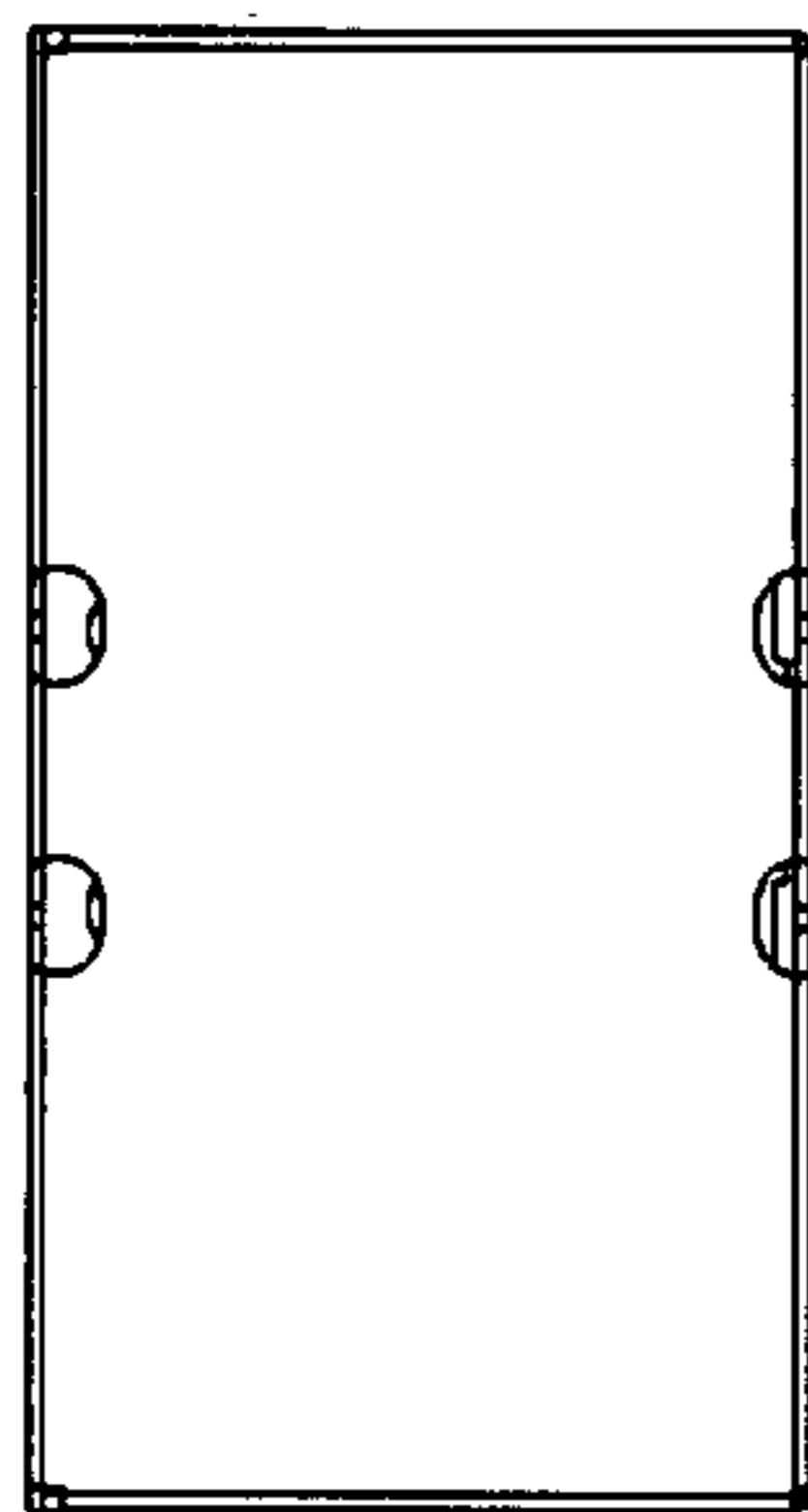

FIGURE 4

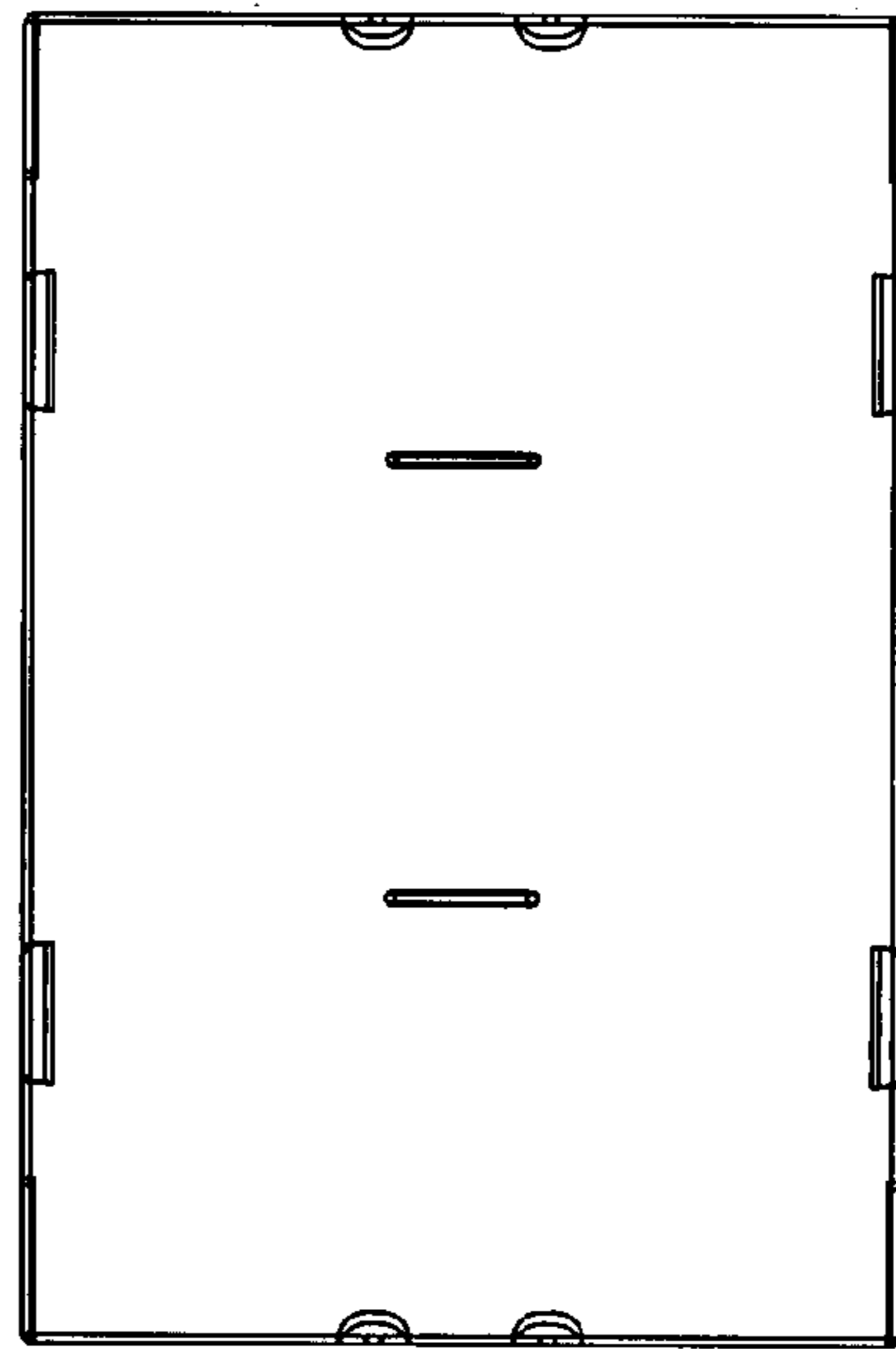

FIGURE 5

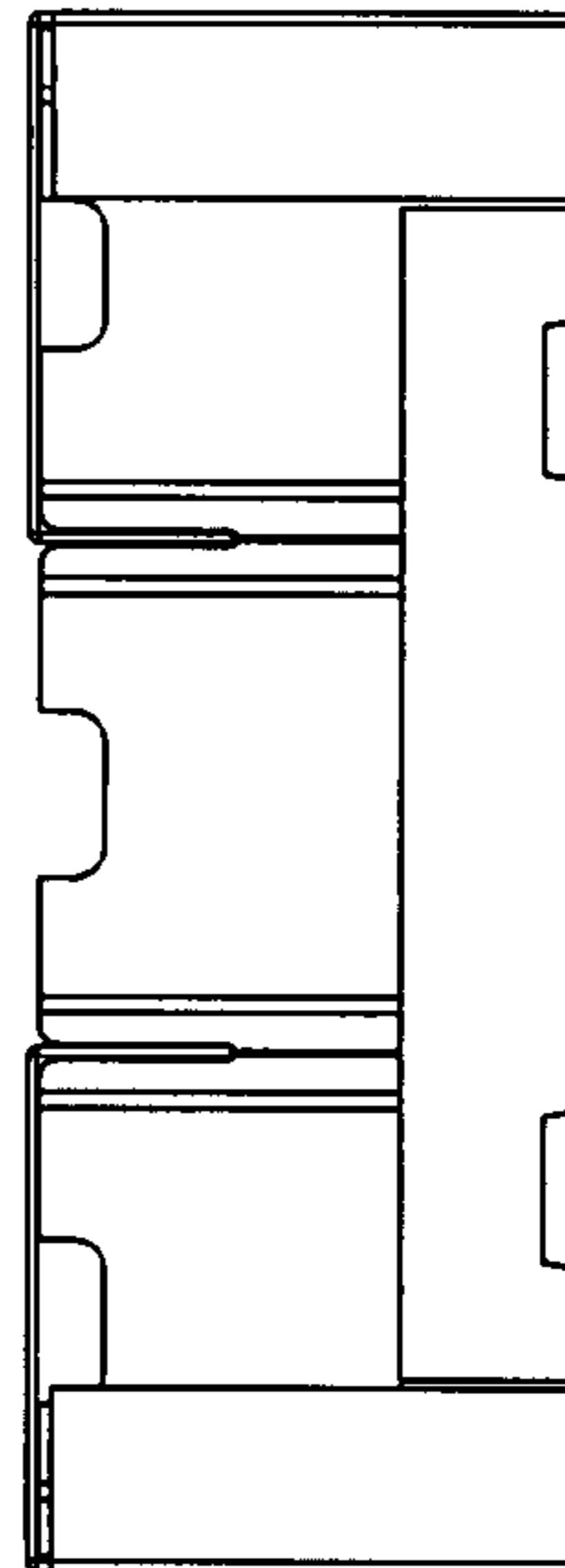

FIGURE 6