



US00D578753S

(12) **United States Design Patent**
Hsu

(10) **Patent No.:** **US D578,753 S**
(45) **Date of Patent:** **** Oct. 21, 2008**

(54) **HANDBAG**

(76) **Inventor:** **Lou Hsu**, 1918 Platinum St., Garland,
TX (US) 75042

(**) **Term:** **14 Years**

(21) **Appl. No.:** **29/298,296**

(22) **Filed:** **Dec. 3, 2007**

(51) **LOC (8) Cl.** **03-01**

(52) **U.S. Cl.** **D3/232**

(58) **Field of Classification Search** D3/232-234,
D3/240-246, 318, 322, 324; 150/100, 103-104,
150/107-110, 114, 118-119

See application file for complete search history.

(56) **References Cited**

U.S. PATENT DOCUMENTS

D374,985 S * 10/1996 Hoyt D3/246

D419,292 S * 1/2000 Barre D3/233

D505,009 S * 5/2005 Rambow et al. D3/244

* cited by examiner

Primary Examiner—Holly H Baynham

(74) *Attorney, Agent, or Firm*—Grady K. Bergen; Griggs
Bergen LLP

(57) **CLAIM**

The ornamental design for a handbag, as shown and
described.

DESCRIPTION

FIGS. 1-7 show a handbag showing my design in a first
configuration and FIGS. 8-14 show the handbag showing my
design in a second configuration; and wherein

FIG. 1 is a front perspective view of the handbag in the first
configuration;

FIG. 2 is a front elevational view of the handbag of FIG. 1;

FIG. 3 is a rear elevational view of the handbag of FIG. 1;

FIG. 4 is an elevational right side view the handbag of FIG. 1;

FIG. 5 an elevational left side view of the handbag of FIG. 1;

FIG. 6 is a bottom plan view of the handbag of FIG. 1;

FIG. 7 is a top plan view of the handbag of FIG. 1;

FIG. 8 is a front perspective view of the handbag in an
expanded position;

FIG. 9 is a front elevational view of the handbag of FIG. 8;

FIG. 10 is a rear elevational view of the handbag of FIG. 8;

FIG. 11 is an elevational right side view the handbag of FIG.
8;

FIG. 12 is an elevational left side view of the handbag of FIG.
8;

FIG. 13 is a bottom plan view of the handbag of FIG. 8; and,

FIG. 14 is a top plan view of the handbag of FIG. 8.

The broken lines are included for the purpose of illustrating
portions of the handbag that form no part of the claimed
design.

1 Claim, 10 Drawing Sheets

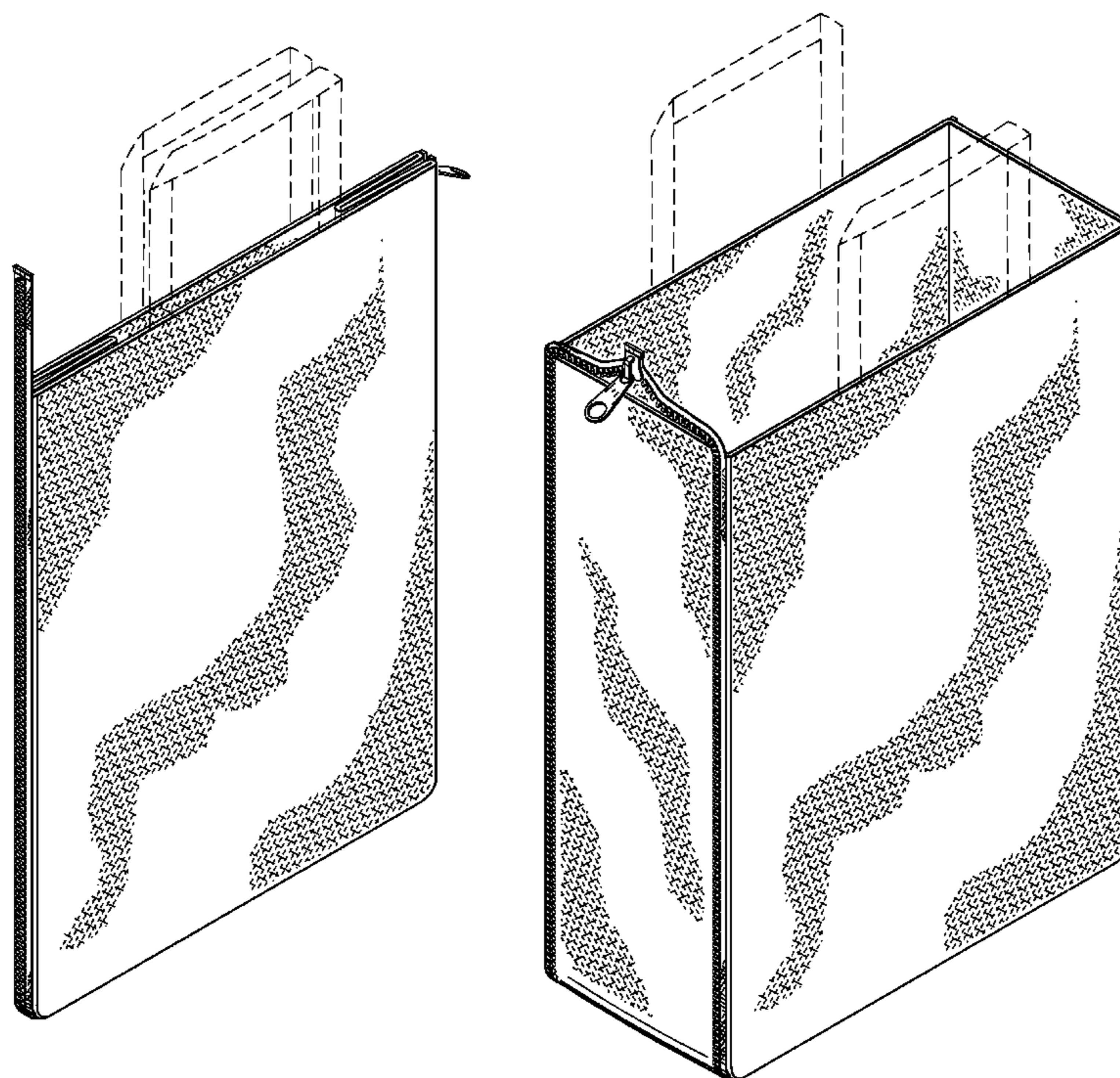

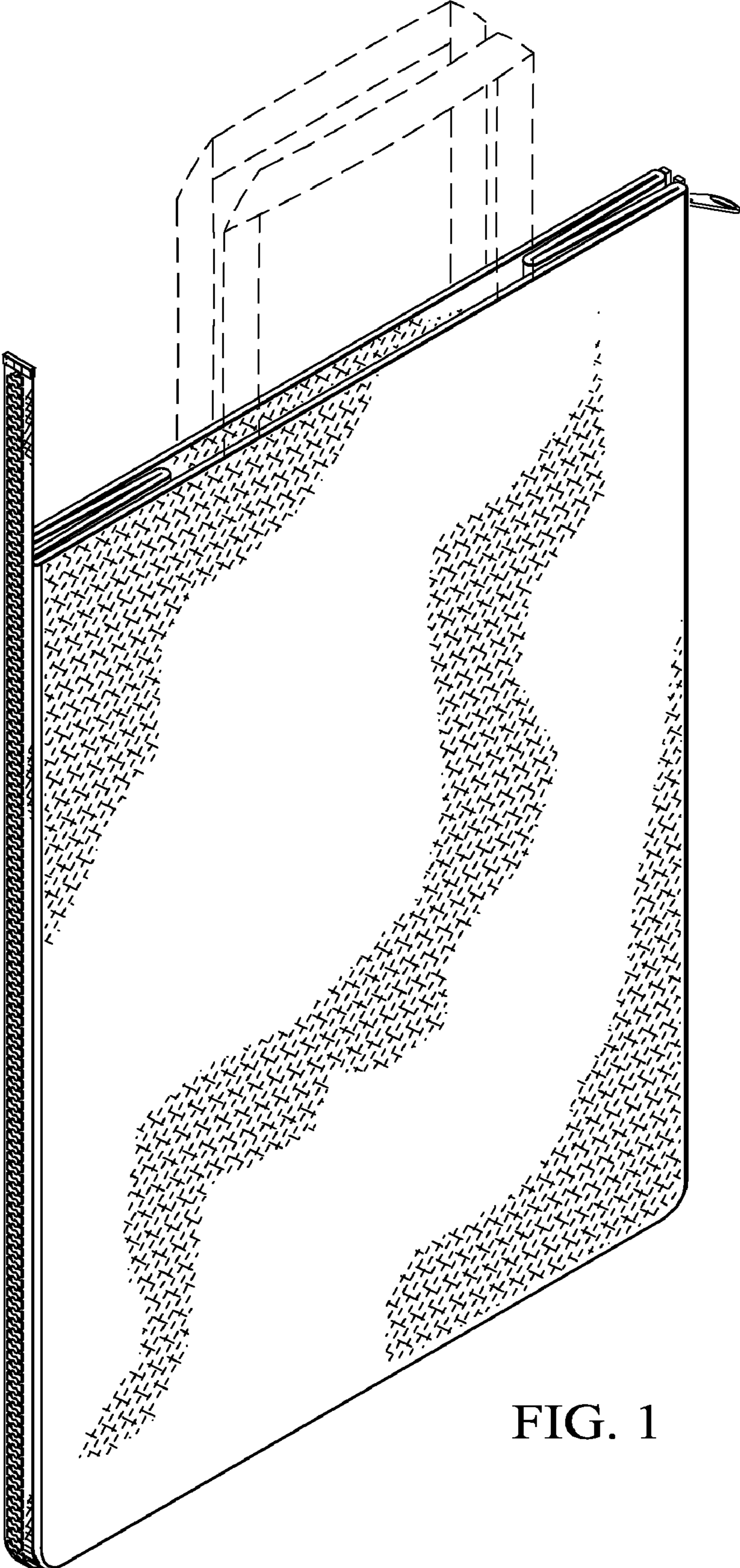

FIG. 1

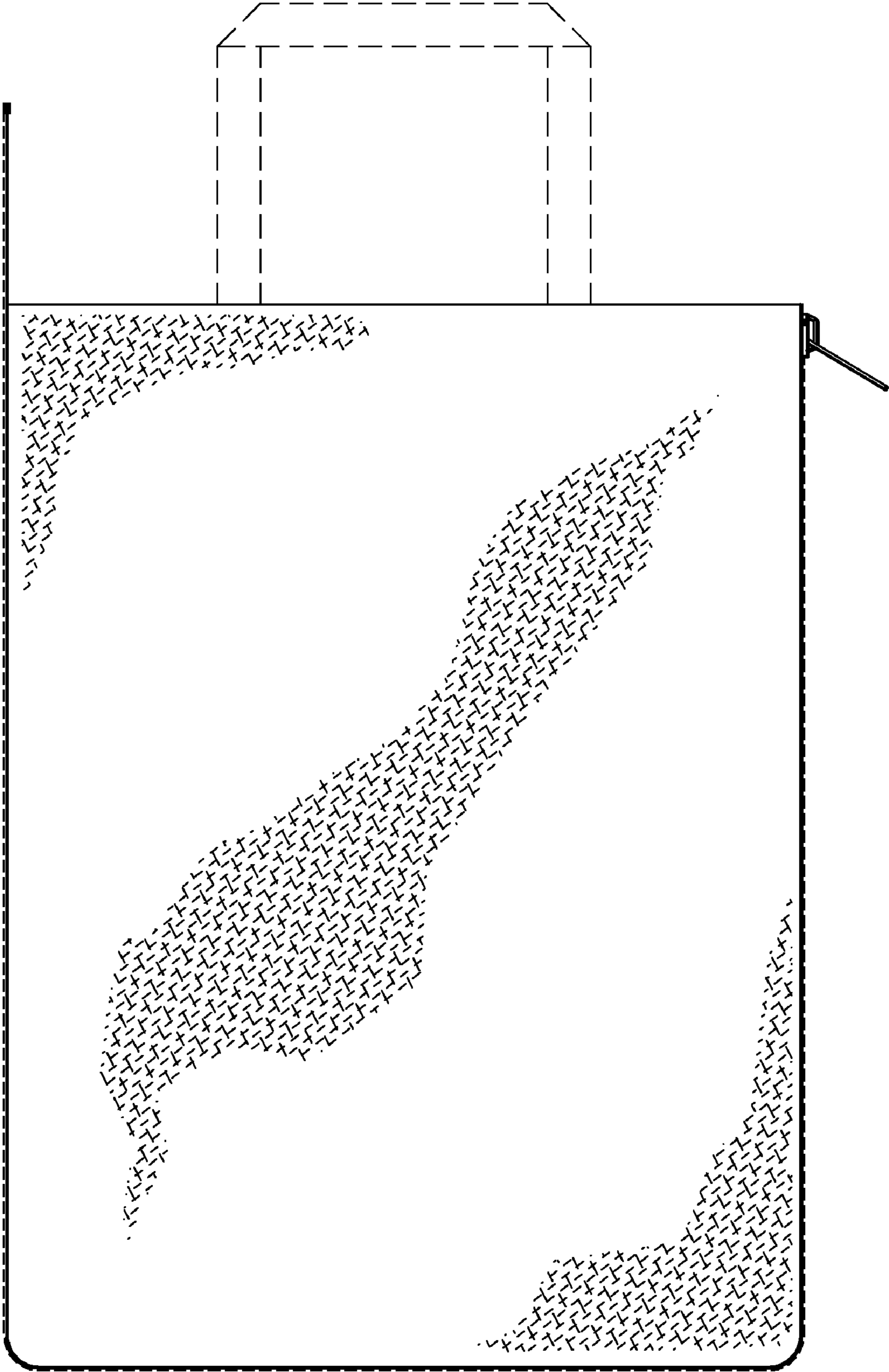

FIG. 2

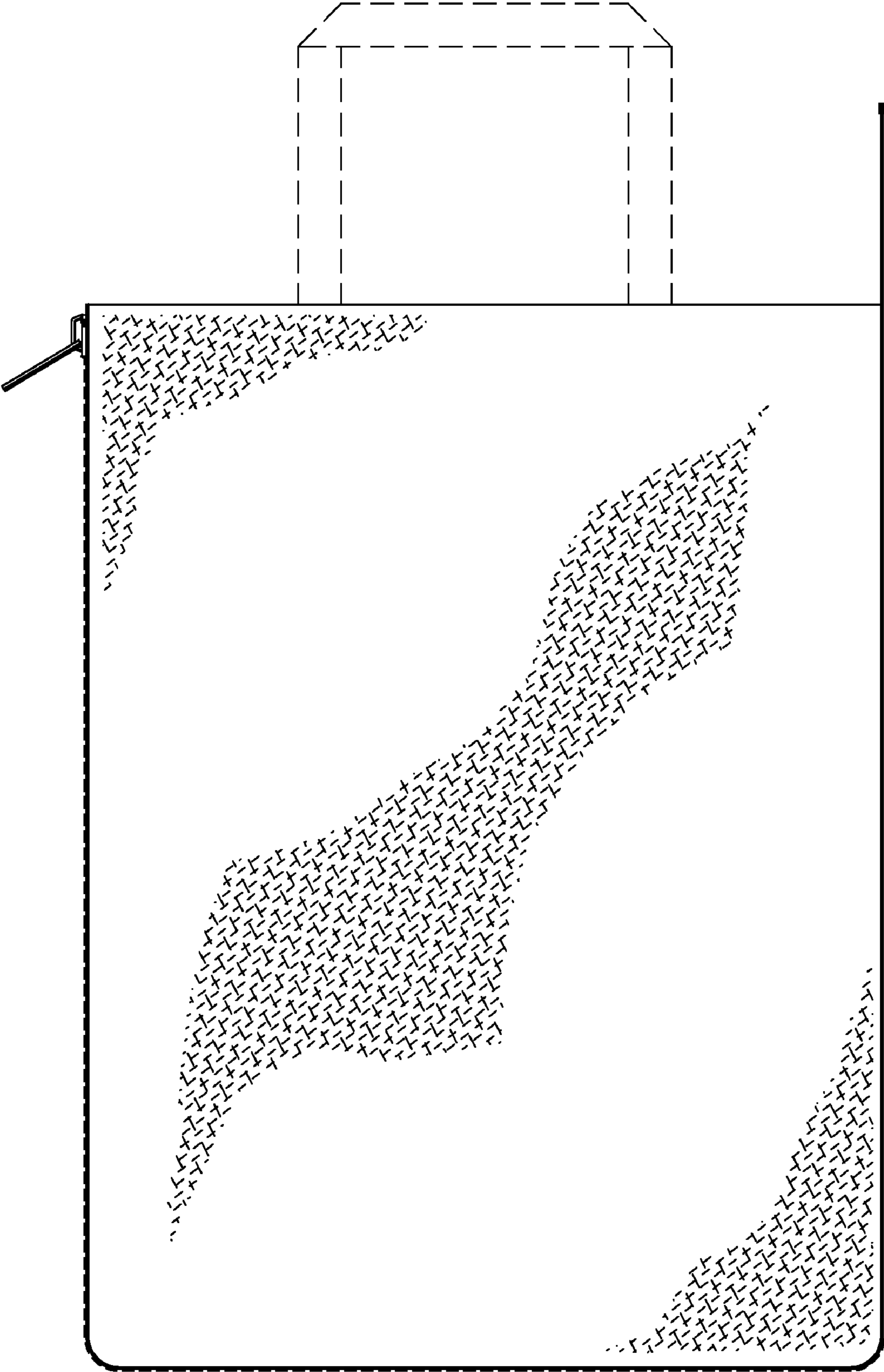

FIG. 3

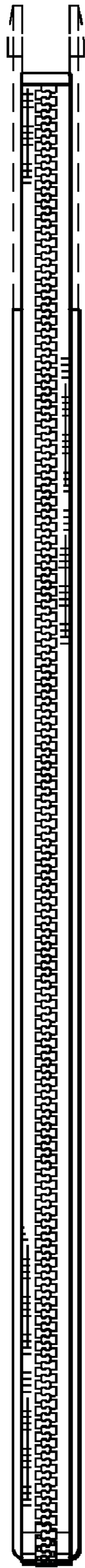

FIG. 4

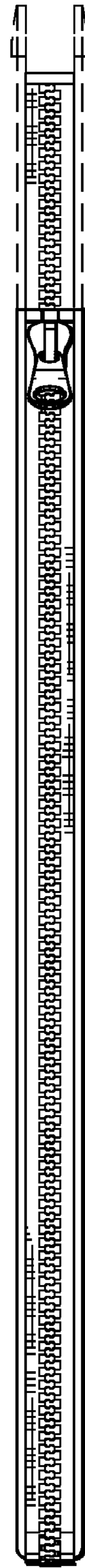

FIG. 5

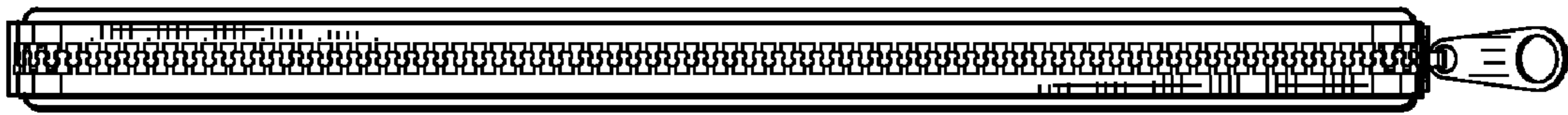

FIG. 6

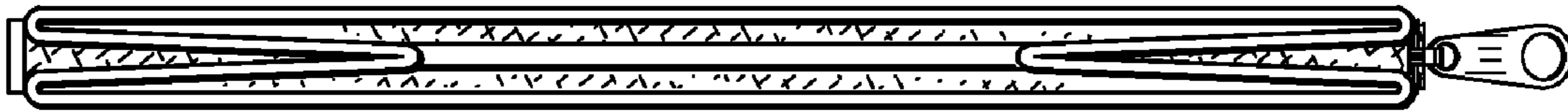

FIG. 7

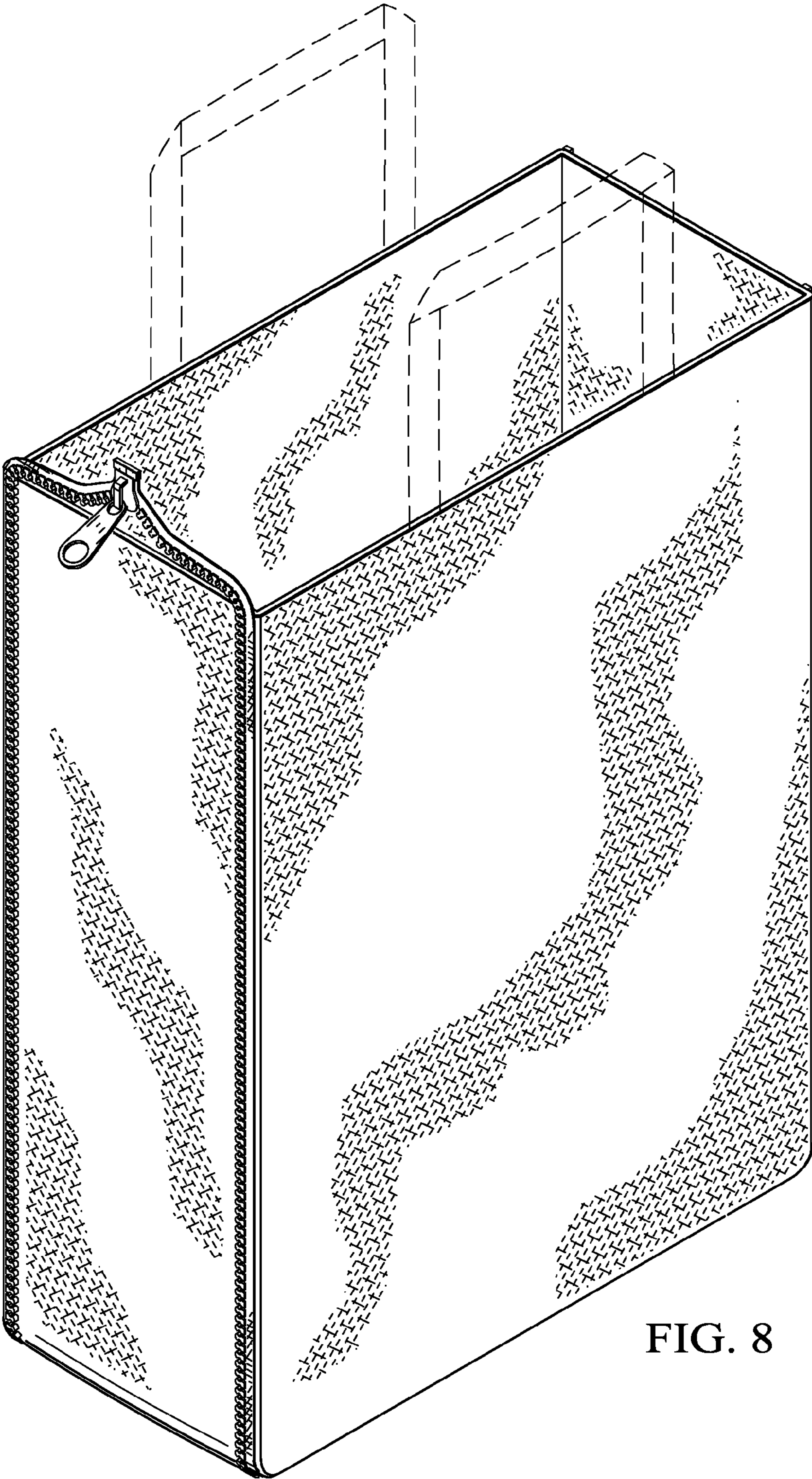

FIG. 8

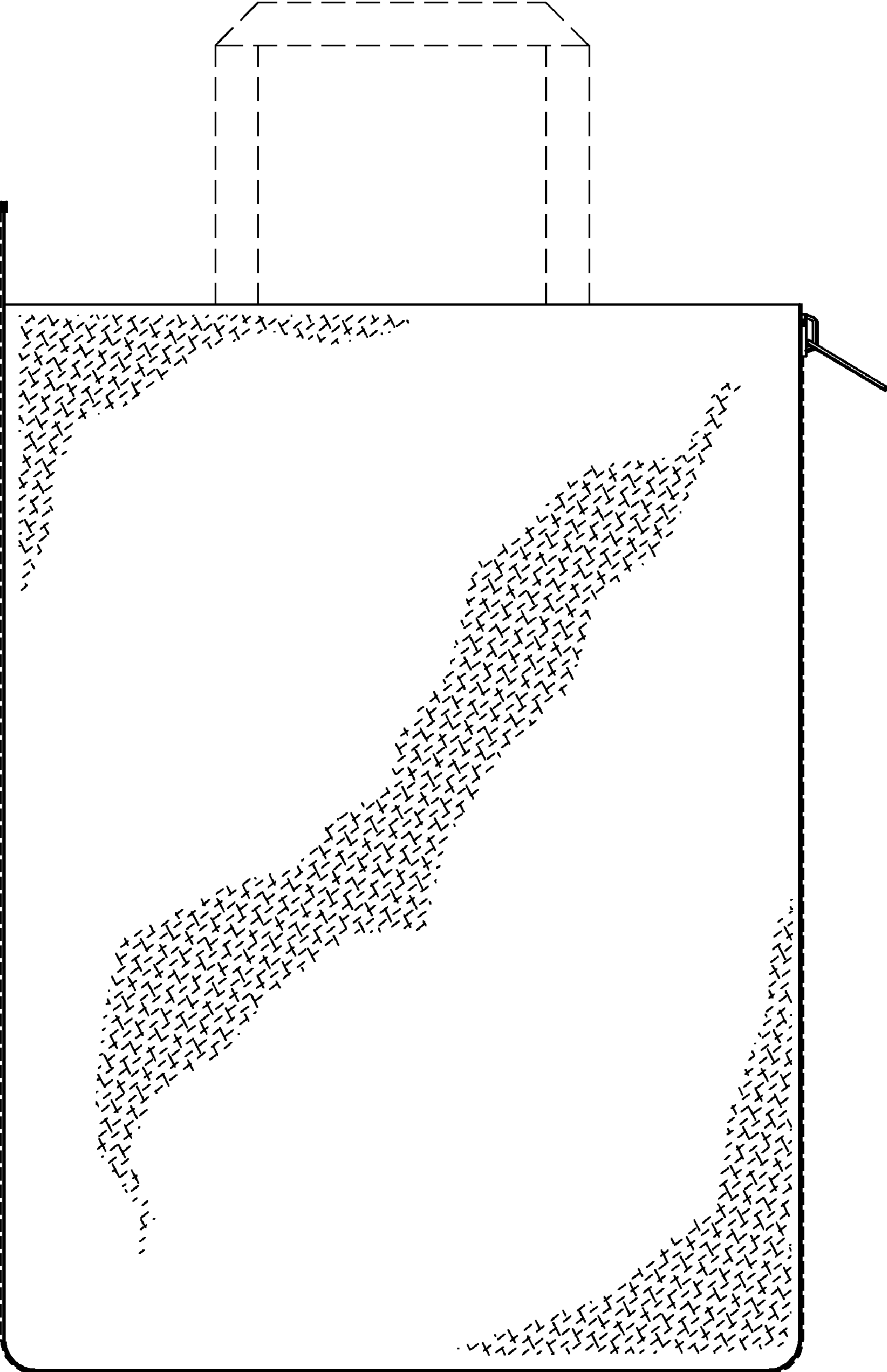

FIG. 9

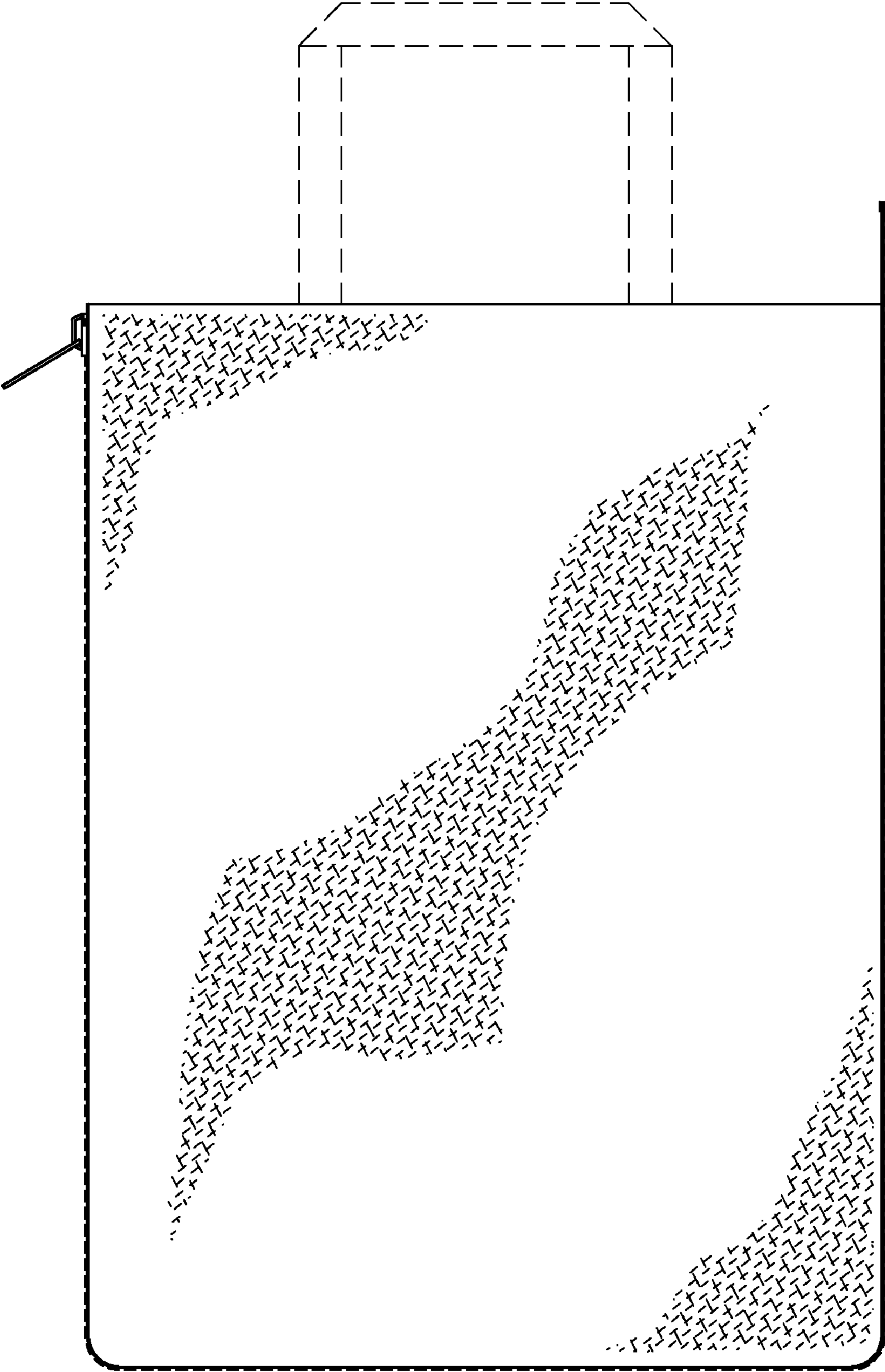

FIG. 10

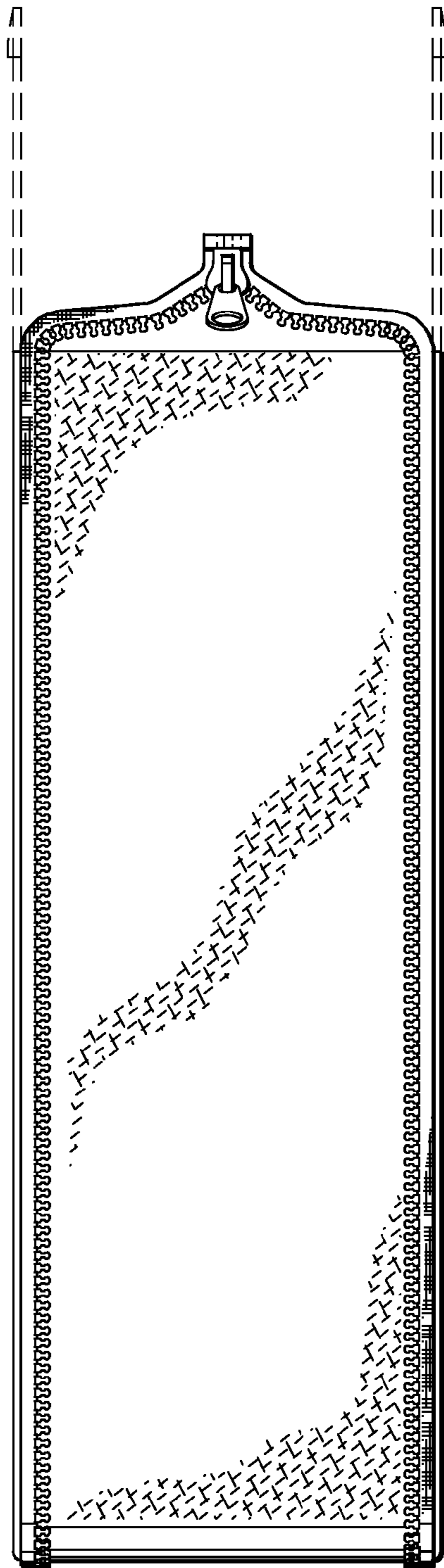

FIG. 11

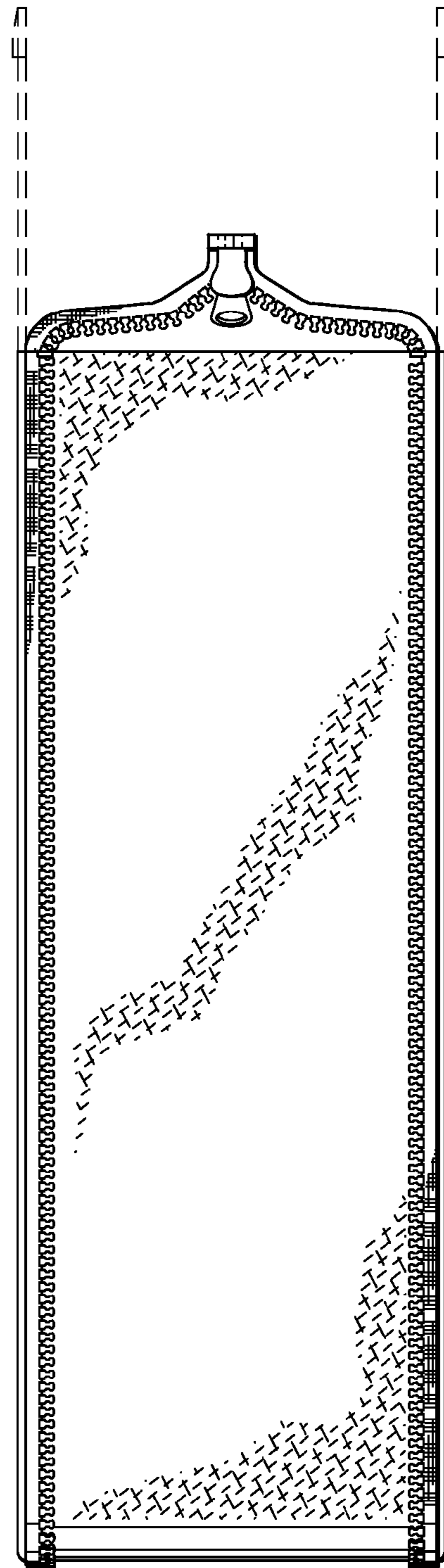

FIG. 12

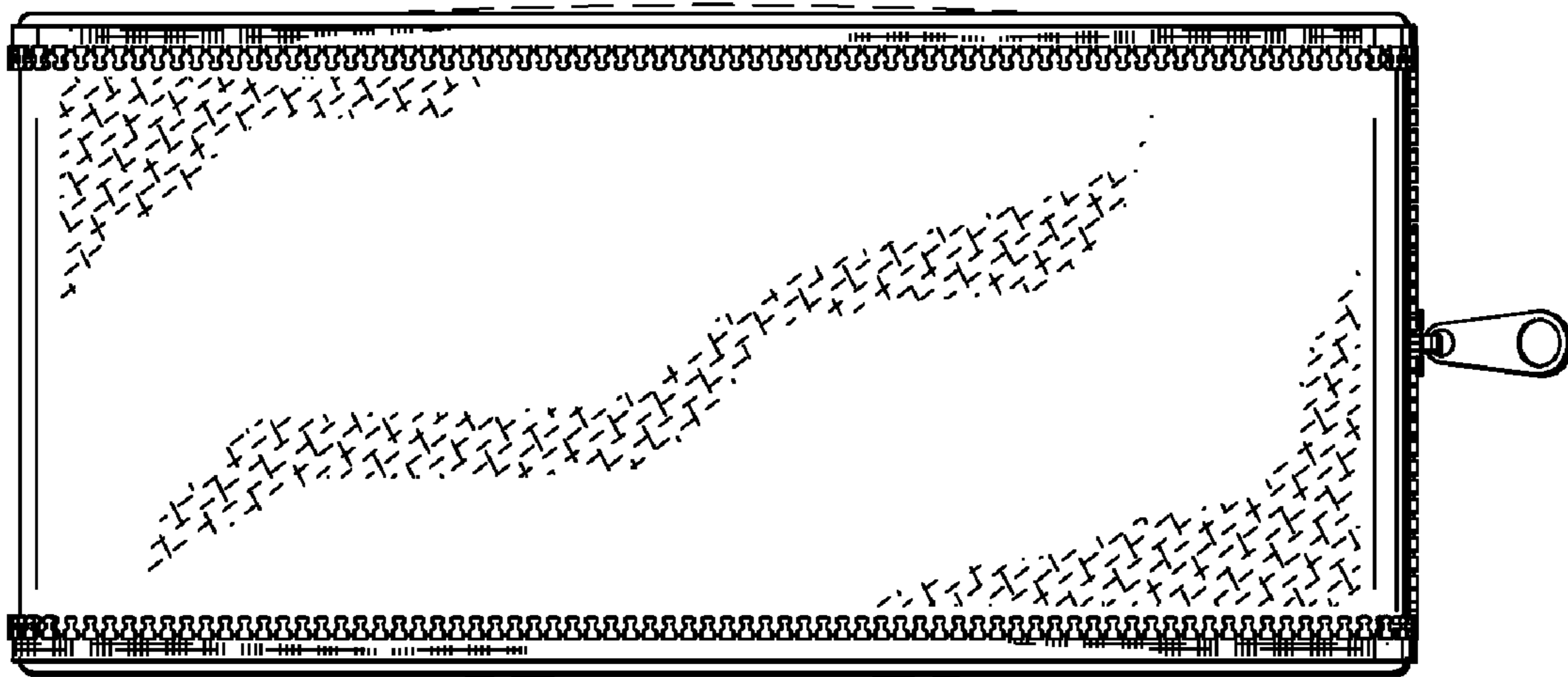

FIG. 13

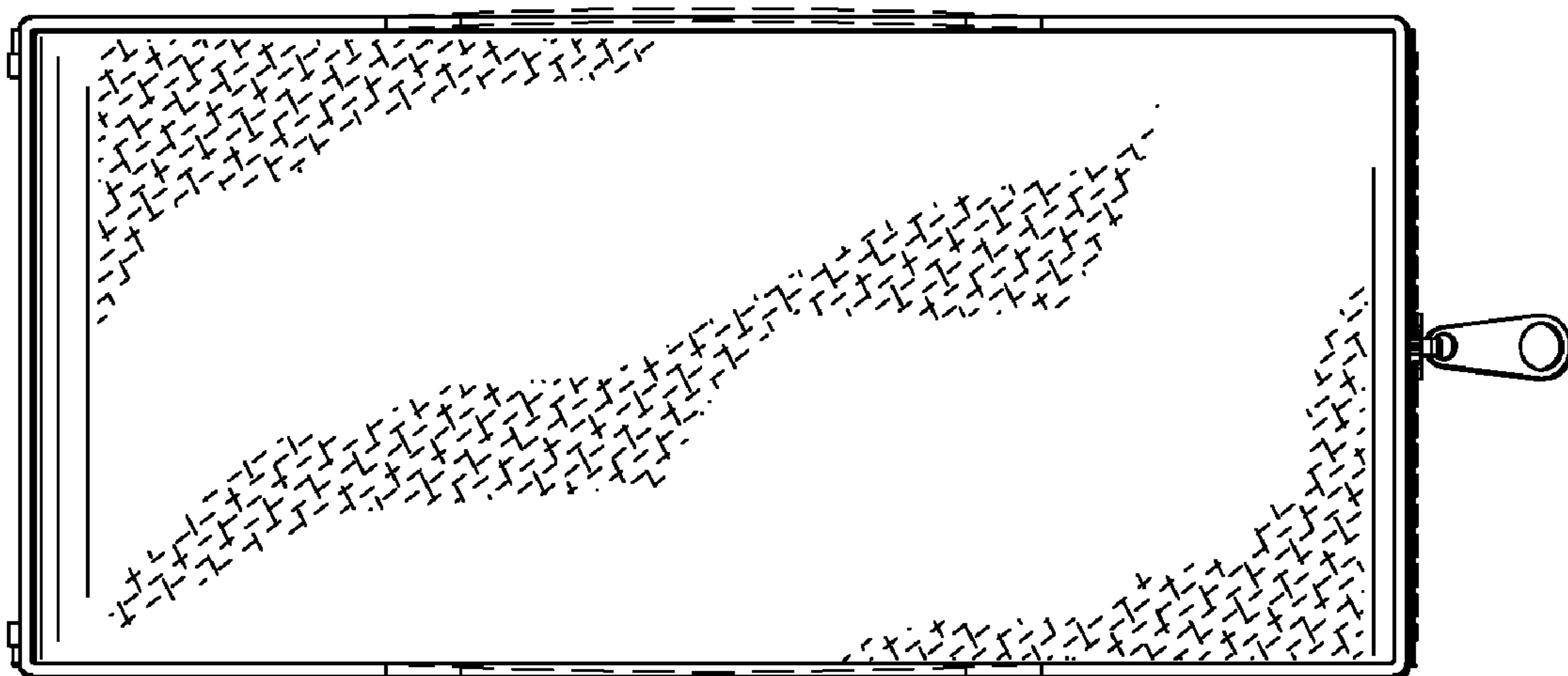

FIG. 14