



US00D578712S

(12) **United States Design Patent**  
**Kouchi et al.**

(10) **Patent No.:** **US D578,712 S**  
(45) **Date of Patent:** **\*\* Oct. 14, 2008**

(54) **HEAD-UP DISPLAY FOR MOTORCYCLES**

(75) Inventors: **Kaoru Kouchi**, Hyogo (JP); **Motoaki Kanou**, Hyogo (JP); **Ai Watabe**, Hyogo (JP)

(73) Assignee: **Kawasaki Jukogyo Kabushiki Kaisha**, Kobe-shi (JP)

(\*\*) Term: **14 Years**

(21) Appl. No.: **29/292,473**

(22) Filed: **Oct. 12, 2007**

(30) **Foreign Application Priority Data**

Apr. 13, 2007 (JP) ..... 2007-009955

(51) **LOC (8) Cl.** ..... **07-02**

(52) **U.S. Cl.** ..... **D29/122**

(58) **Field of Classification Search** ..... D29/102–107, D29/122; 2/410–412, 414, 416–425, 5, 6.6–6.8, 2/452, DIG. 11, 8.1, 9, 10; 128/201.22, 207.17; D26/51; 362/105–107

See application file for complete search history.

(56) **References Cited**

**U.S. PATENT DOCUMENTS**

D296,719 S *	7/1988	Lester	.....	D29/103
D359,145 S *	6/1995	Harrison et al.	.....	D29/102
D360,058 S *	7/1995	Reede	.....	D29/103
D406,400 S *	3/1999	Munns	.....	D29/107
D454,987 S *	3/2002	Hahm	.....	D29/122
6,439,733 B1 *	8/2002	Fischer et al.	.....	362/106

D474,862 S *	5/2003	Perez, Sr.	.....	D29/106
2005/0174753 A1 *	8/2005	Cao et al.	.....	362/106
2007/0097668 A1 *	5/2007	Choi	.....	362/105
2007/0217184 A1 *	9/2007	Berry	.....	362/105

\* cited by examiner

*Primary Examiner*—Ruth McInroy

(74) *Attorney, Agent, or Firm*—Alleman Hall McCoy Russell & Tuttle LLP

(57) **CLAIM**

The ornamental design for a head-up display for motorcycles, as shown and described.

**DESCRIPTION**

FIG. 1 is a front view of a head-up display for motorcycles, according to the present invention.

FIG. 2 is a rear view of the head-up display of FIG. 1.

FIG. 3 is a top view of the head-up display of FIG. 1.

FIG. 4 is a bottom view of the head-up display of FIG. 1.

FIG. 5 is a left side view of the head-up display of FIG. 1.

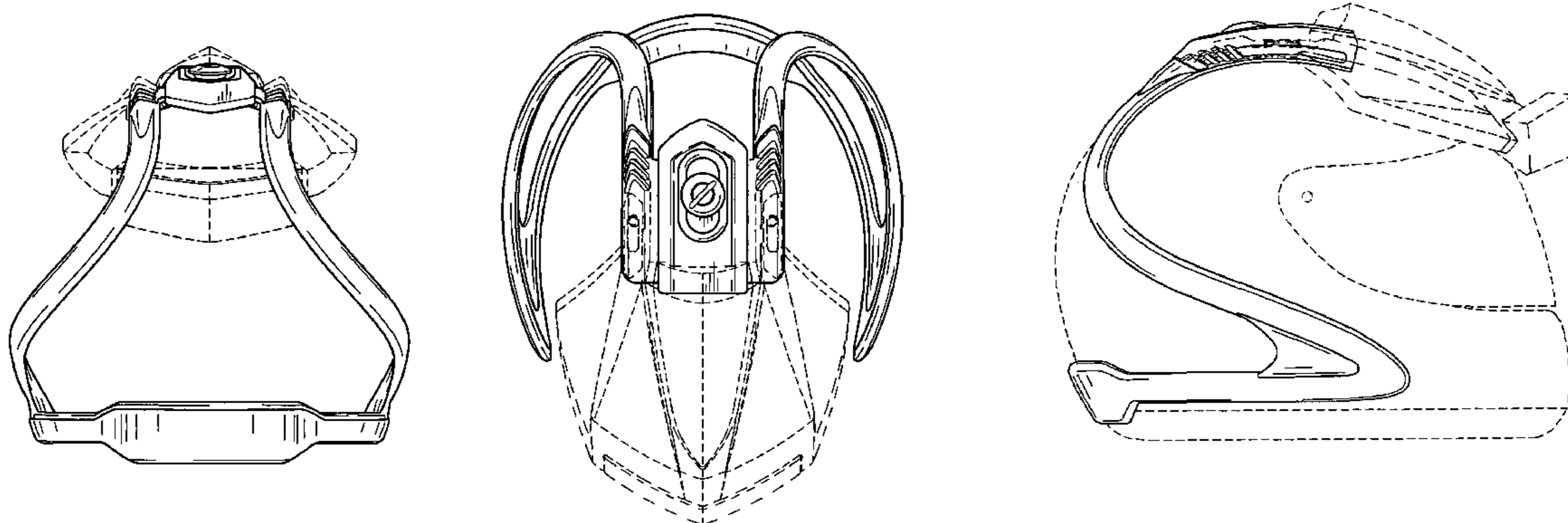
FIG. 6 is a right side view of the head-up display of FIG. 1.

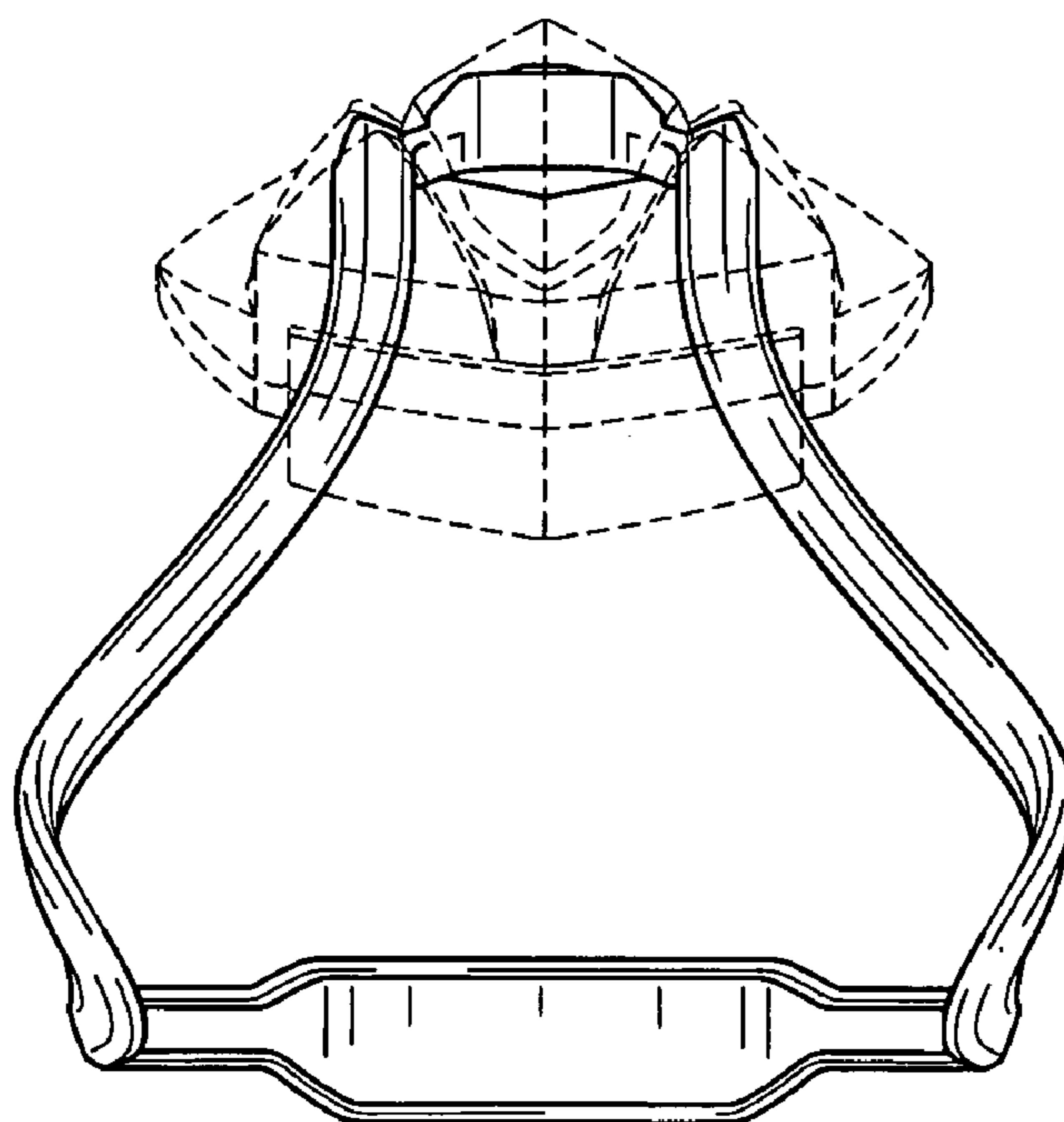
FIG. 7 is a left side view of the head-up display of FIG. 1 in a first orientation in a helmet environment; and,

FIG. 8 is a left side view of the head-up display of FIG. 1 in a second orientation in a helmet environment.

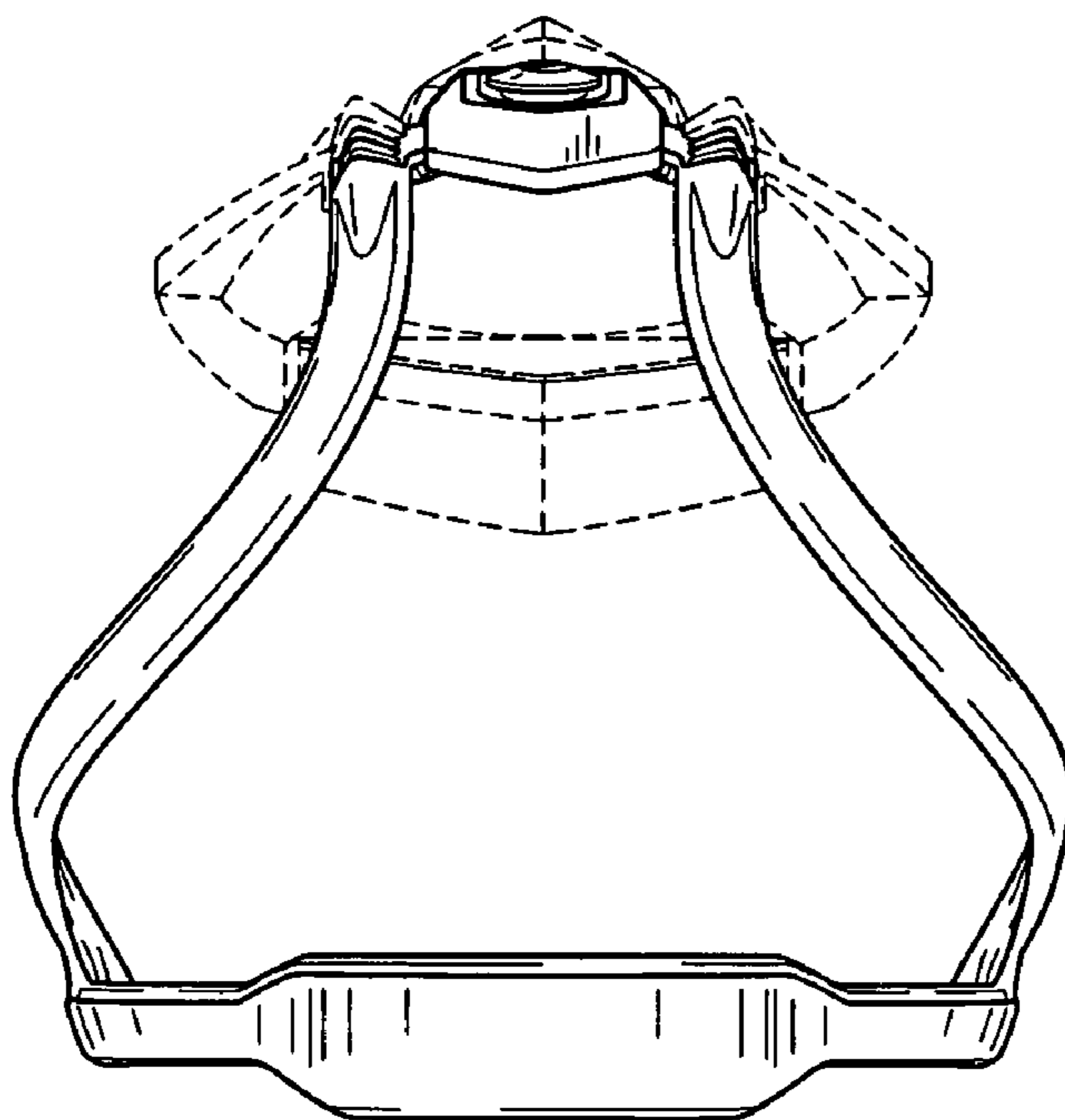
The broken lines are for illustrative purposes only, and form no part of the claimed design.

**1 Claim, 4 Drawing Sheets**

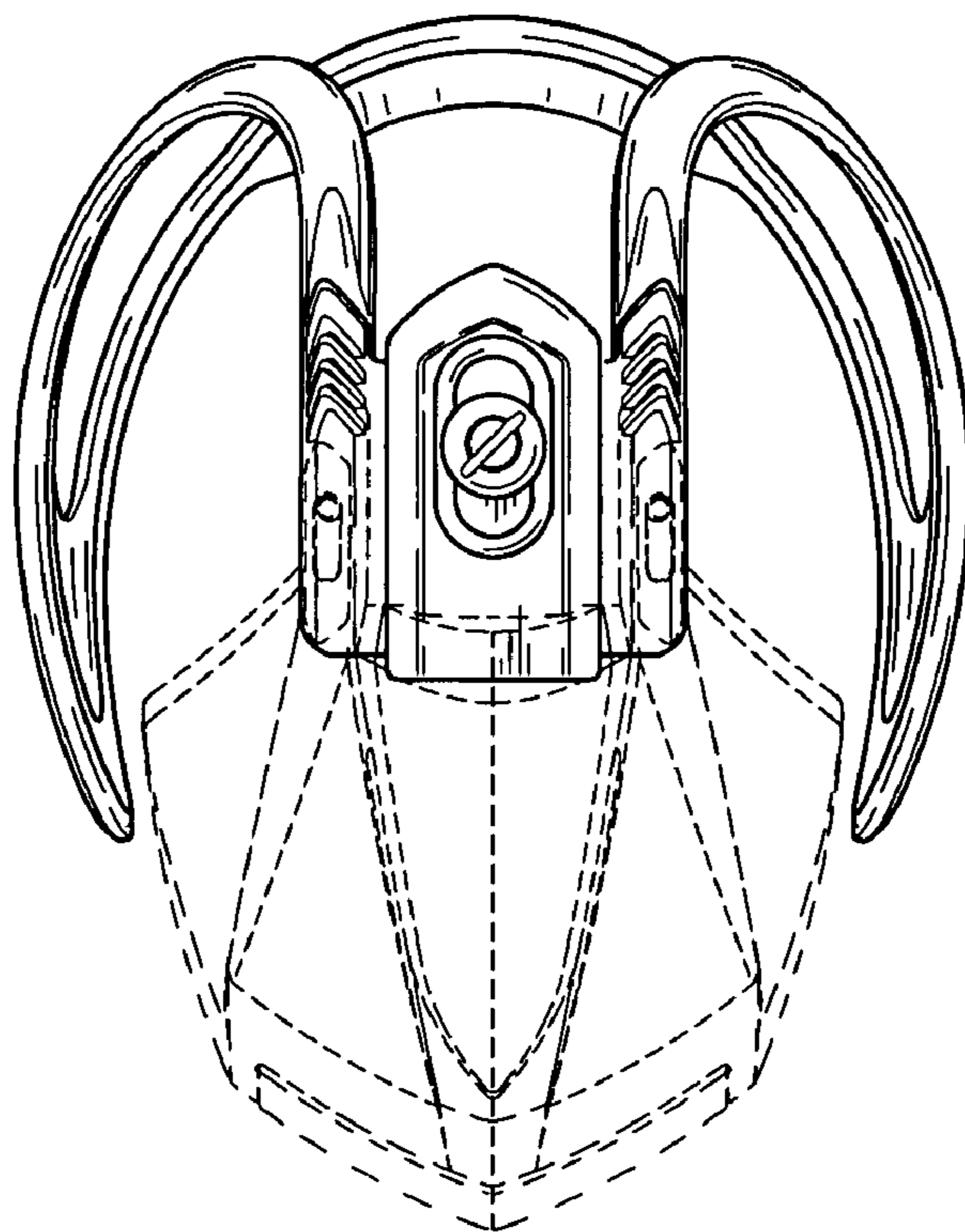




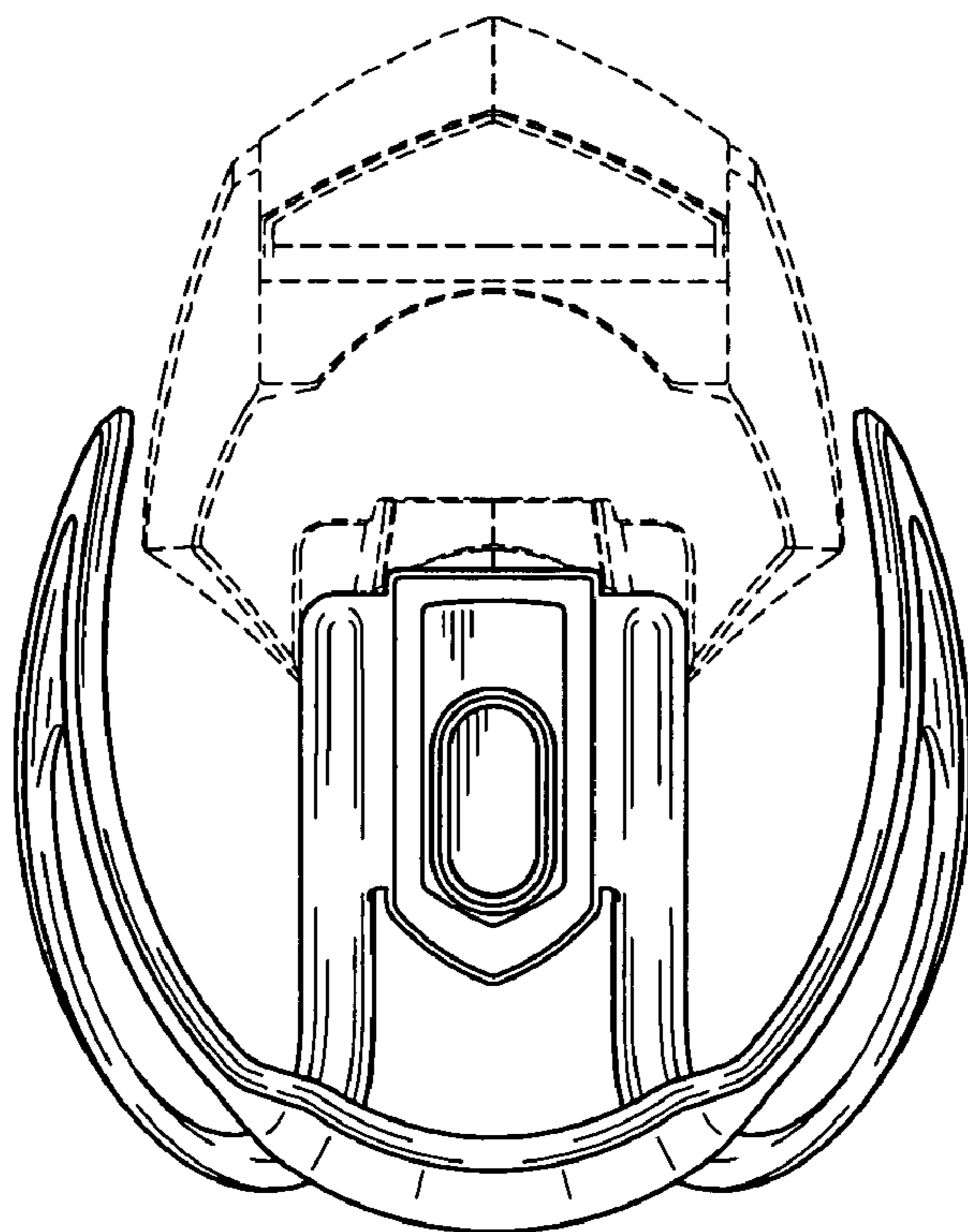
**FIG. 1**



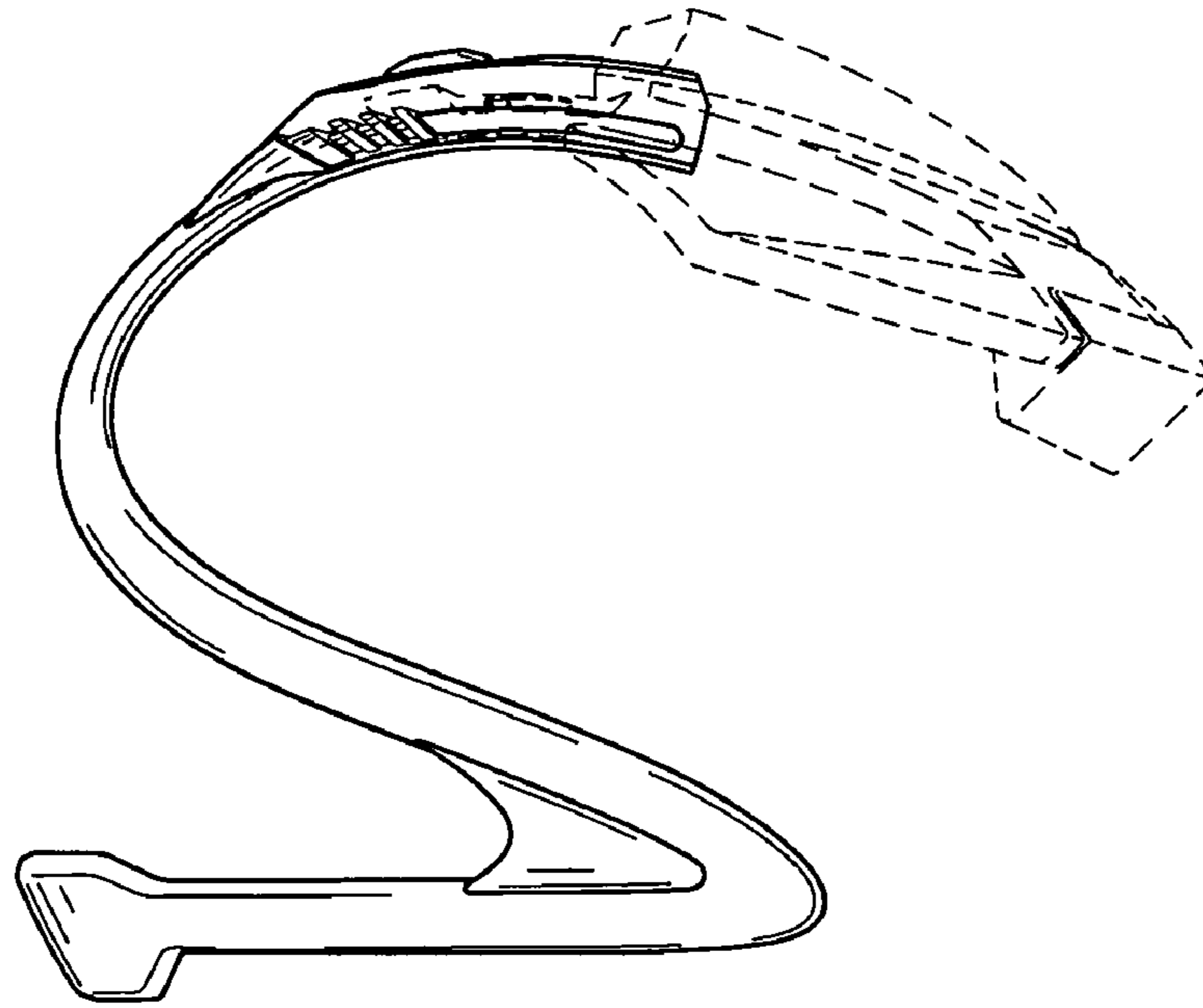
**FIG. 2**



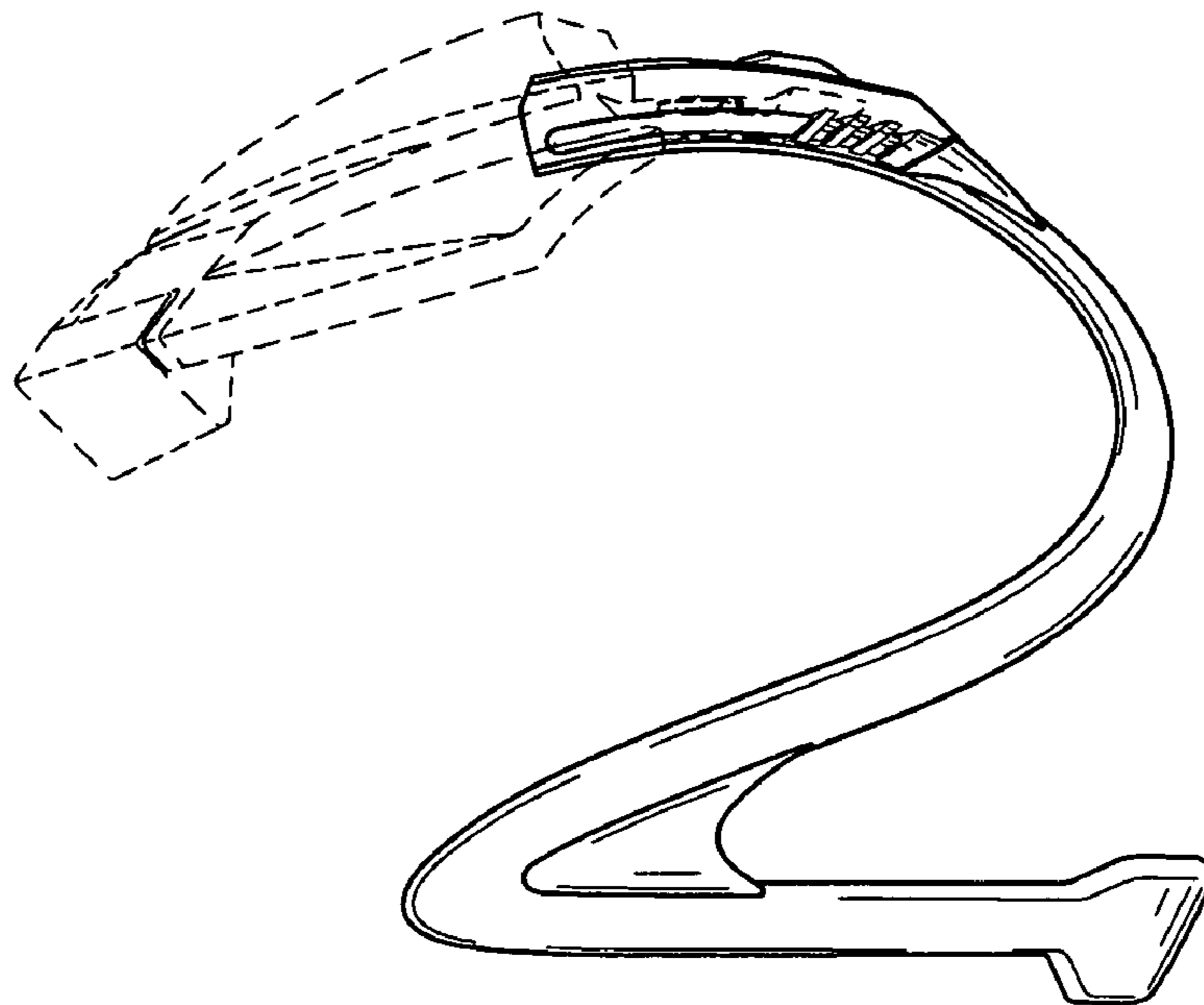
**FIG. 3**



**FIG. 4**

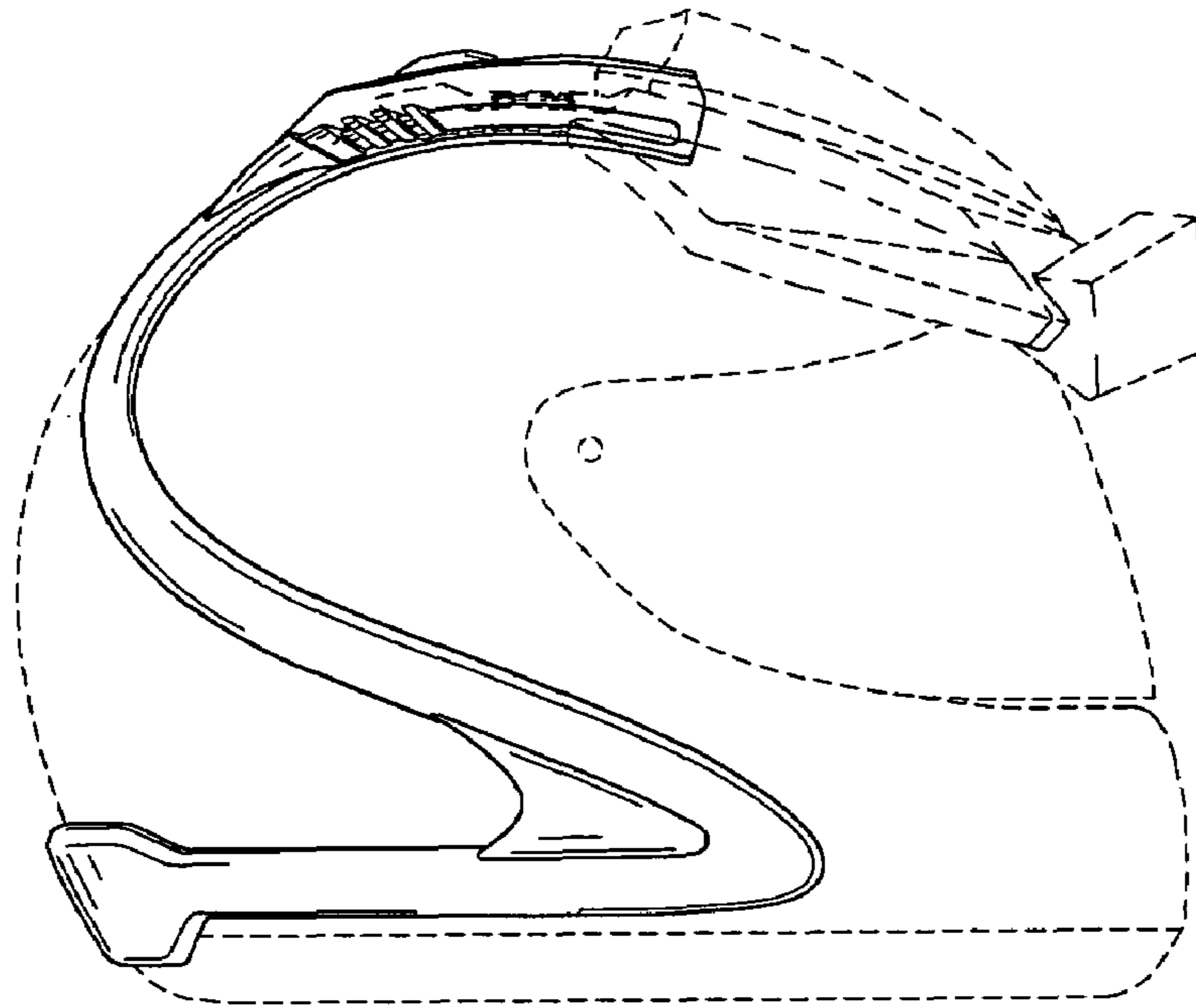


**FIG. 5**

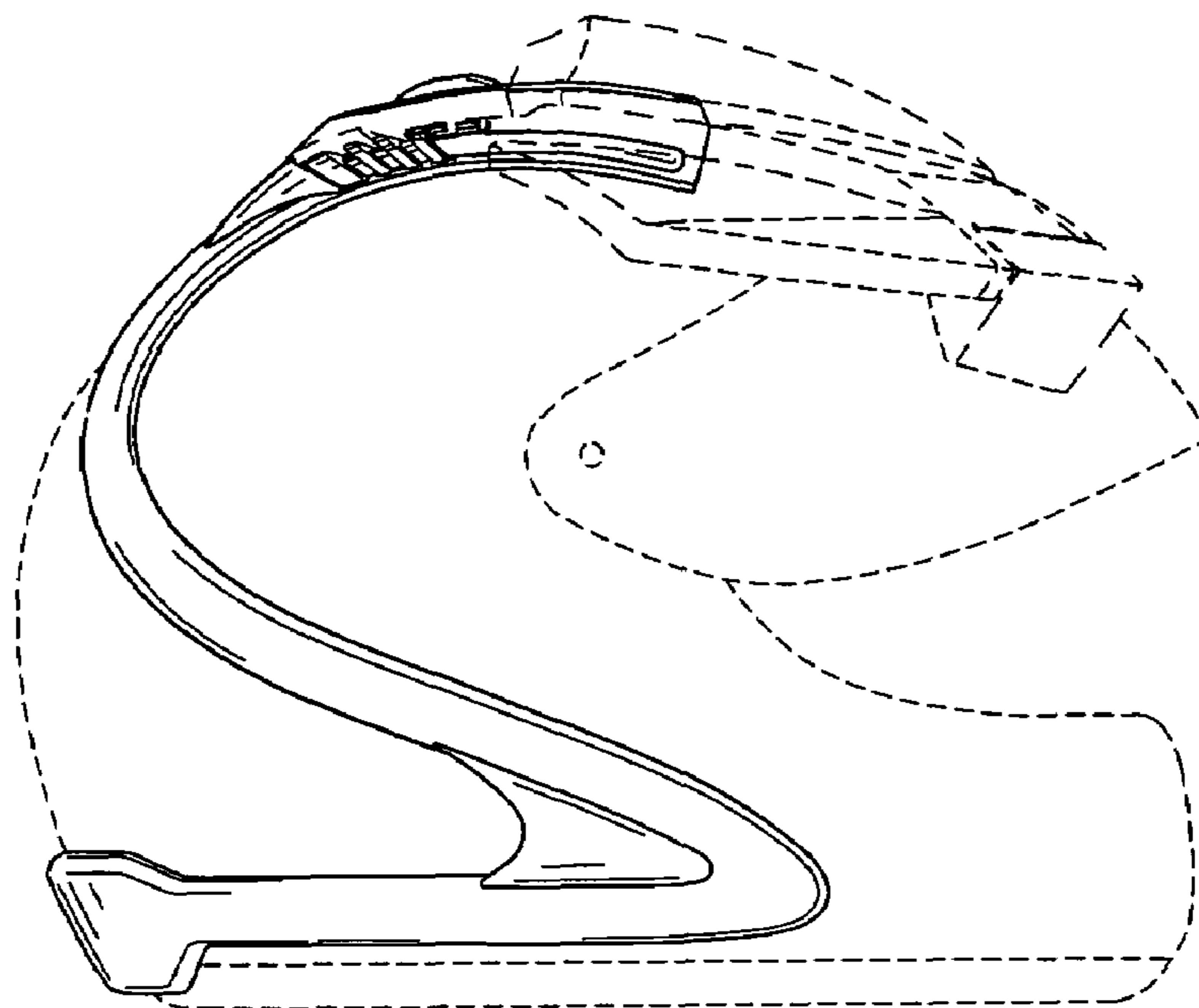


**FIG. 6**





**FIG. 7**



**FIG. 8**