



US00D578700S

(12) **United States Design Patent**
Chen

(10) **Patent No.:** **US D578,700 S**
(45) **Date of Patent:** **** Oct. 14, 2008**

(54) **LIGHTING FIXTURE**

(76) Inventor: **Chia-Teh Chen**, 5F., No. 30, Yisian Rd., Taipei City (TW)

(**) Term: **14 Years**

(21) Appl. No.: **29/300,604**

(22) Filed: **Apr. 17, 2008**

(51) **LOC (8) Cl.** **26-03**

(52) **U.S. Cl.** **D26/81**

(58) **Field of Classification Search** D26/81,
D26/83, 84, 142-144, 155; 362/147, 404,
362/405, 407

See application file for complete search history.

(56) **References Cited**

U.S. PATENT DOCUMENTS

D430,689	S	*	9/2000	Chiang	D26/80
D430,691	S	*	9/2000	Von Kluck	D26/85
D514,727	S	*	2/2006	Chen	D26/81
D521,175	S	*	5/2006	Dolan	D26/81
D553,782	S	*	10/2007	Nicholas	D26/81
2006/0146548	A1	*	7/2006	Pazula et al.	362/405

OTHER PUBLICATIONS

Fixture #F1759/6 BK from the Flat Iron Collection on p. 86, and All fixtures shown on p. 87 of the Murray-Feiss 2004 edition of "The Big Book" catalog.*

Fixture #1679AP, "Olympia" on p. 160 of the Kichler Lighting Catalog #104; © 2004.*

Fixture #1604OZ, "Benton" on p. s500 of the Kichler Lighting supplemental 2005 catalog.*

* cited by examiner

Primary Examiner—Clare E Heflin

(74) *Attorney, Agent, or Firm*—Rosenberg, Klein & Lee

(57) **CLAIM**

The ornamental design for a "lighting fixture," as shown and described.

DESCRIPTION

FIG. 1 is a perspective view of a "lighting fixture" showing my new design;

FIG. 2 is a front view thereof;

FIG. 3 is a rear view thereof;

FIG. 4 is a left side view thereof;

FIG. 5 is a right side view thereof;

FIG. 6 is a top view thereof;

FIG. 7 is a bottom view thereof; and,

FIG. 8 is a perspective view showing the practical usage thereof.

The broken lines shown on the drawings form no part of the claimed design.

1 Claim, 8 Drawing Sheets

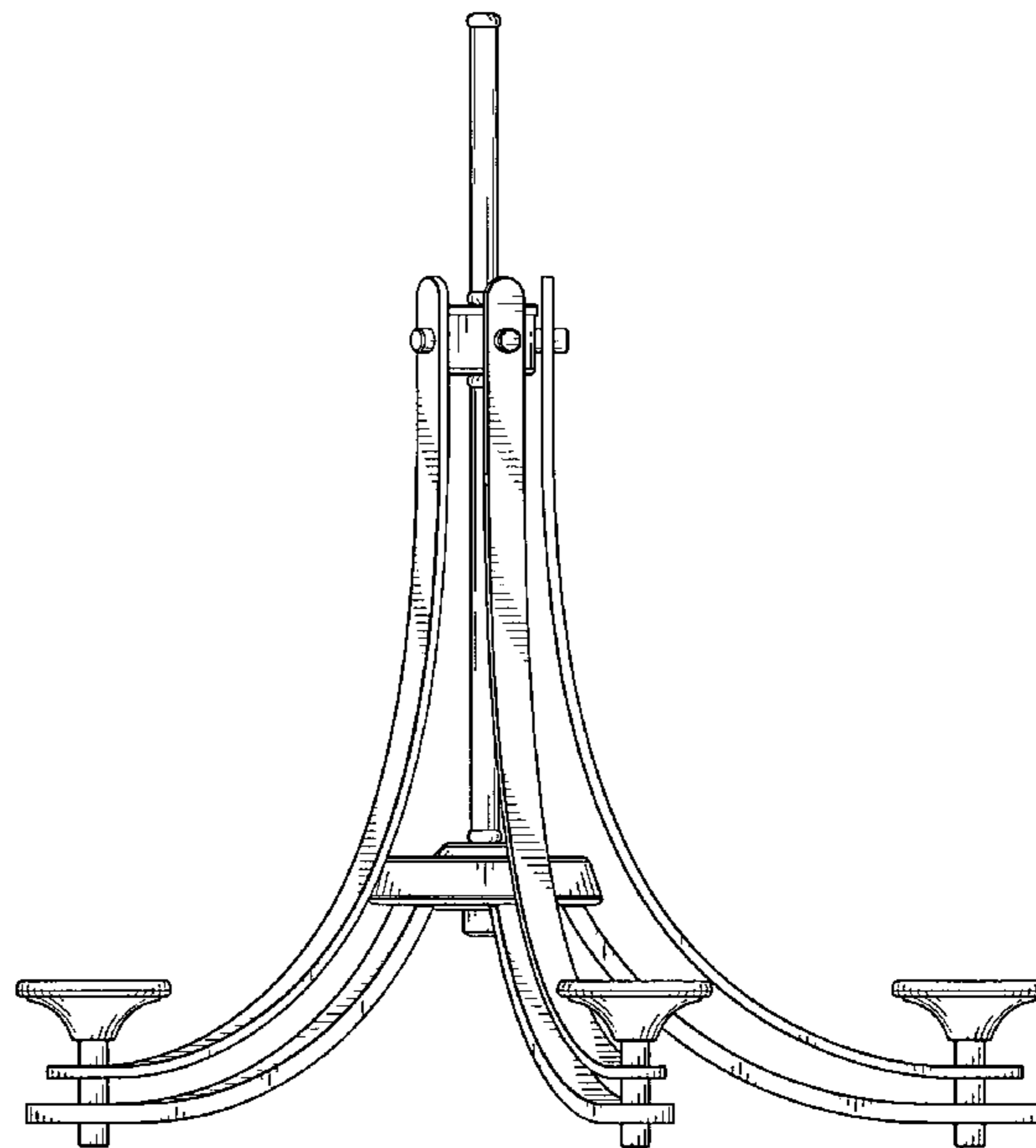
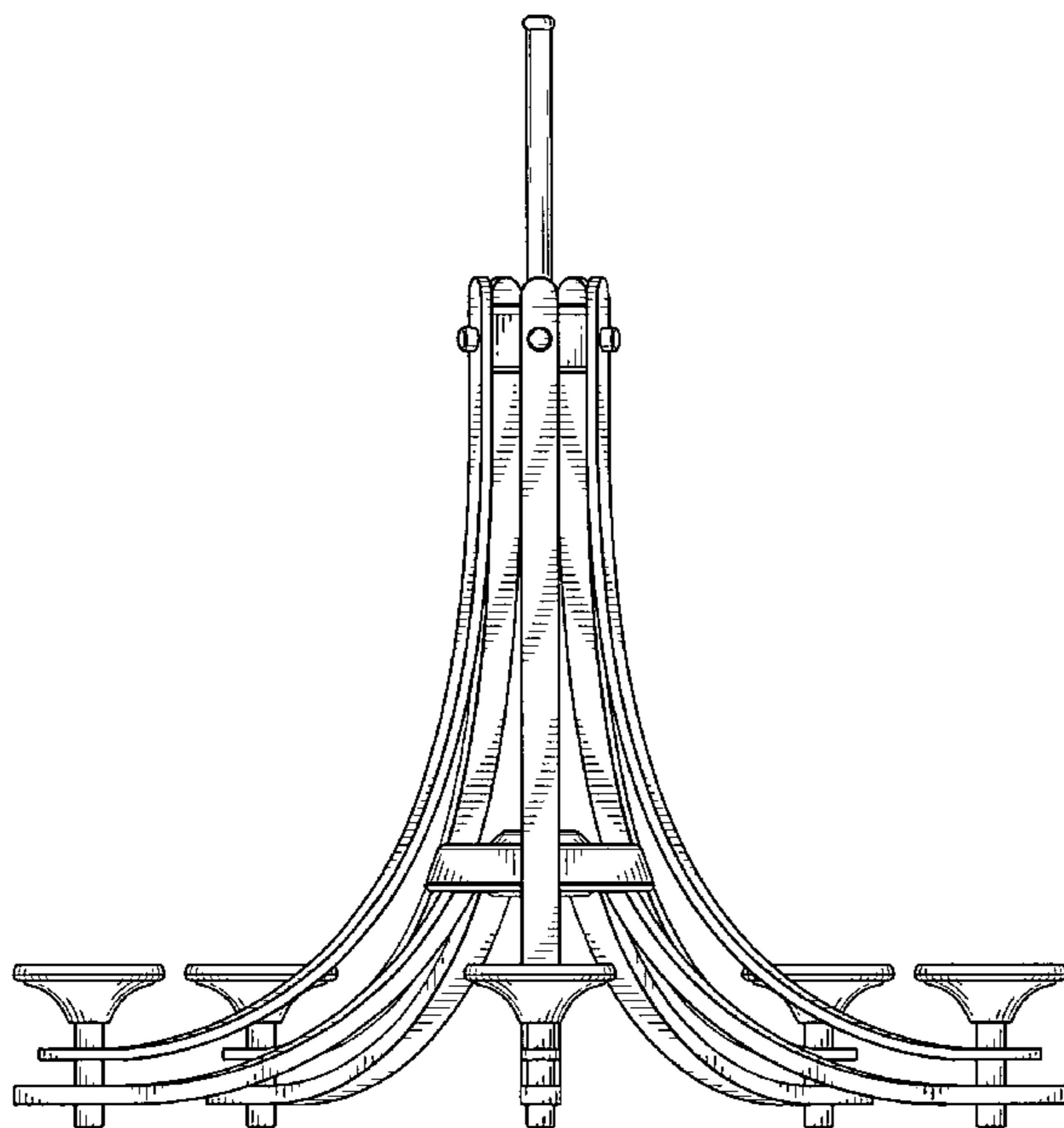

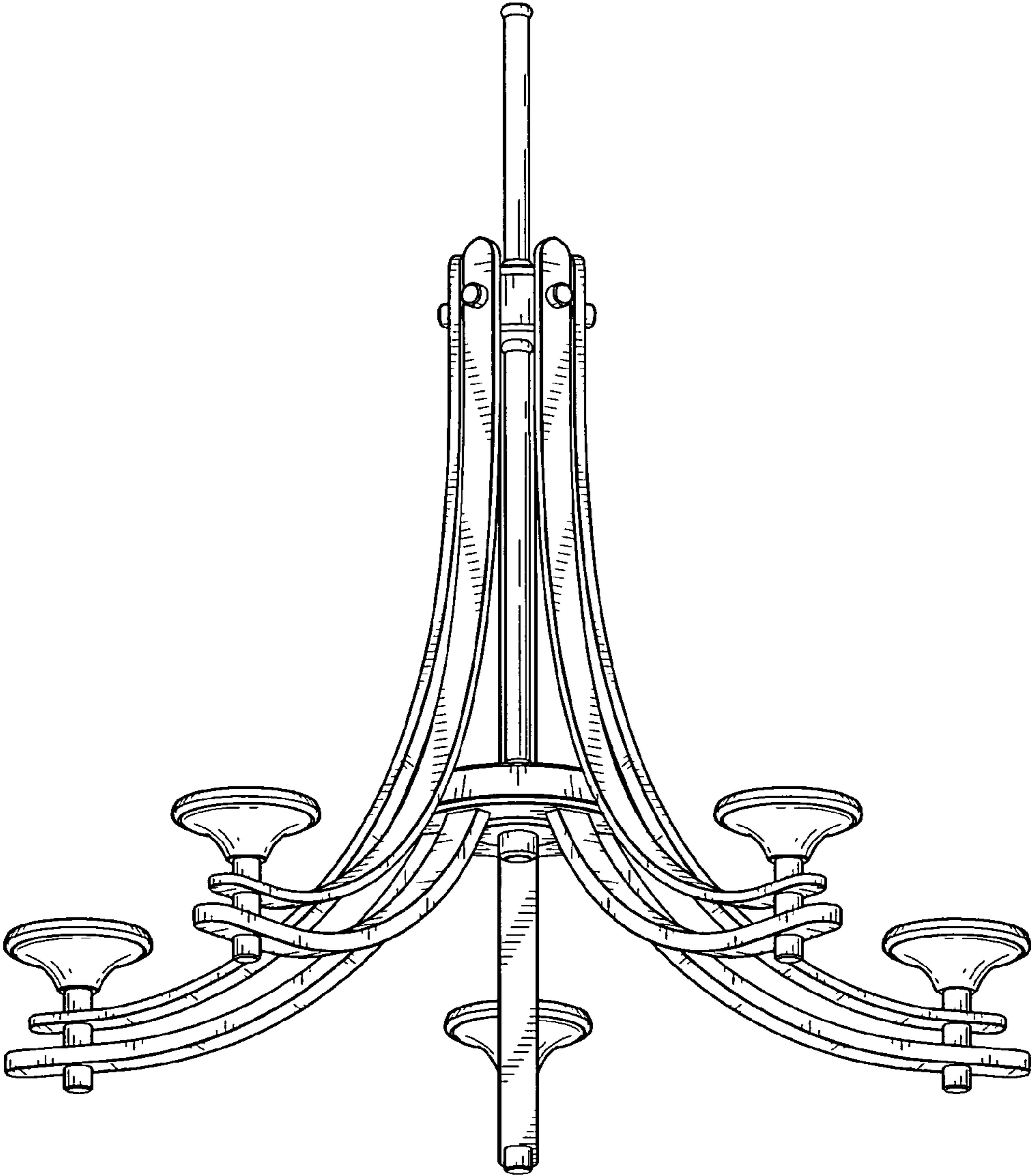

FIG. 1

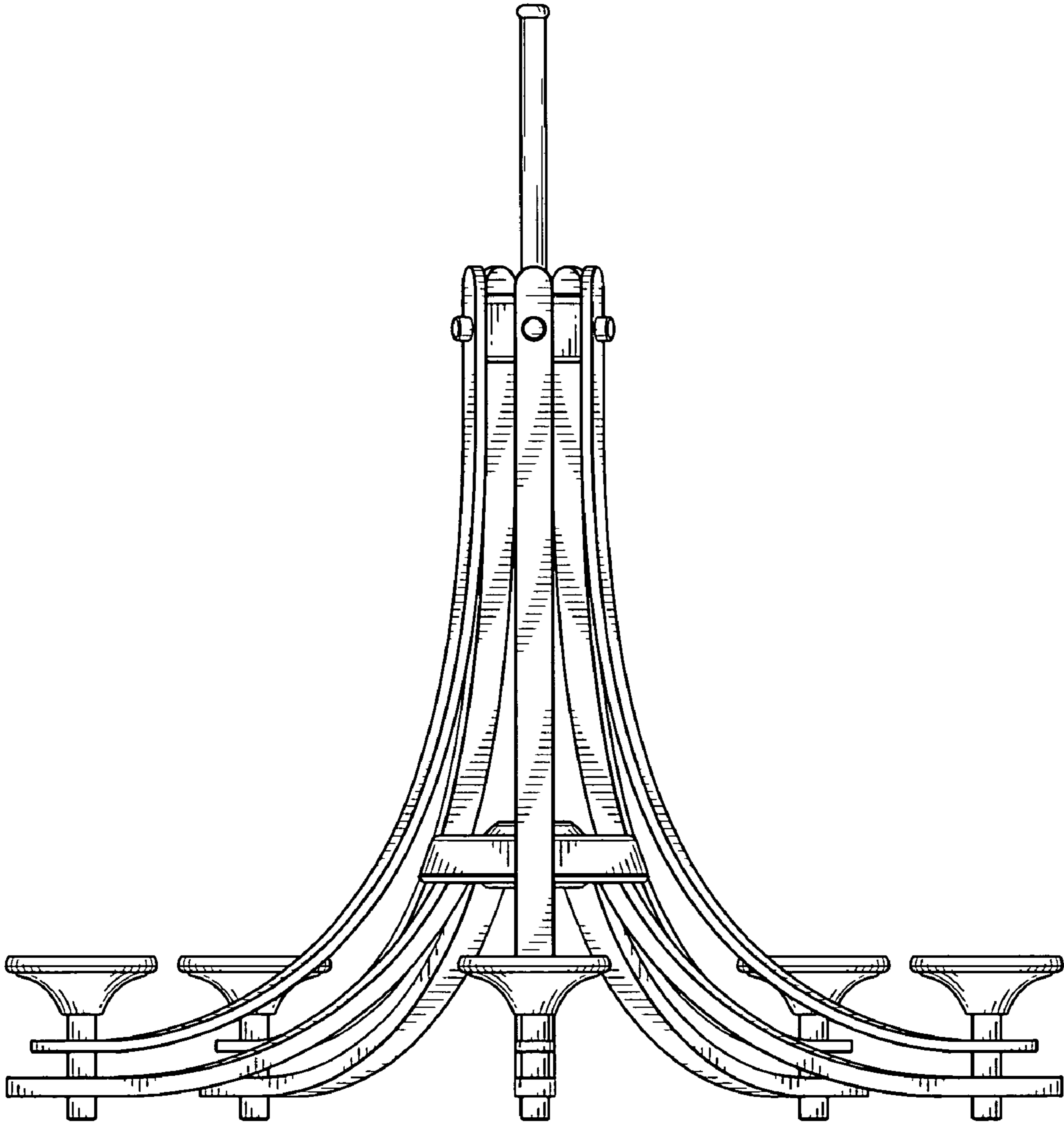

FIG. 2

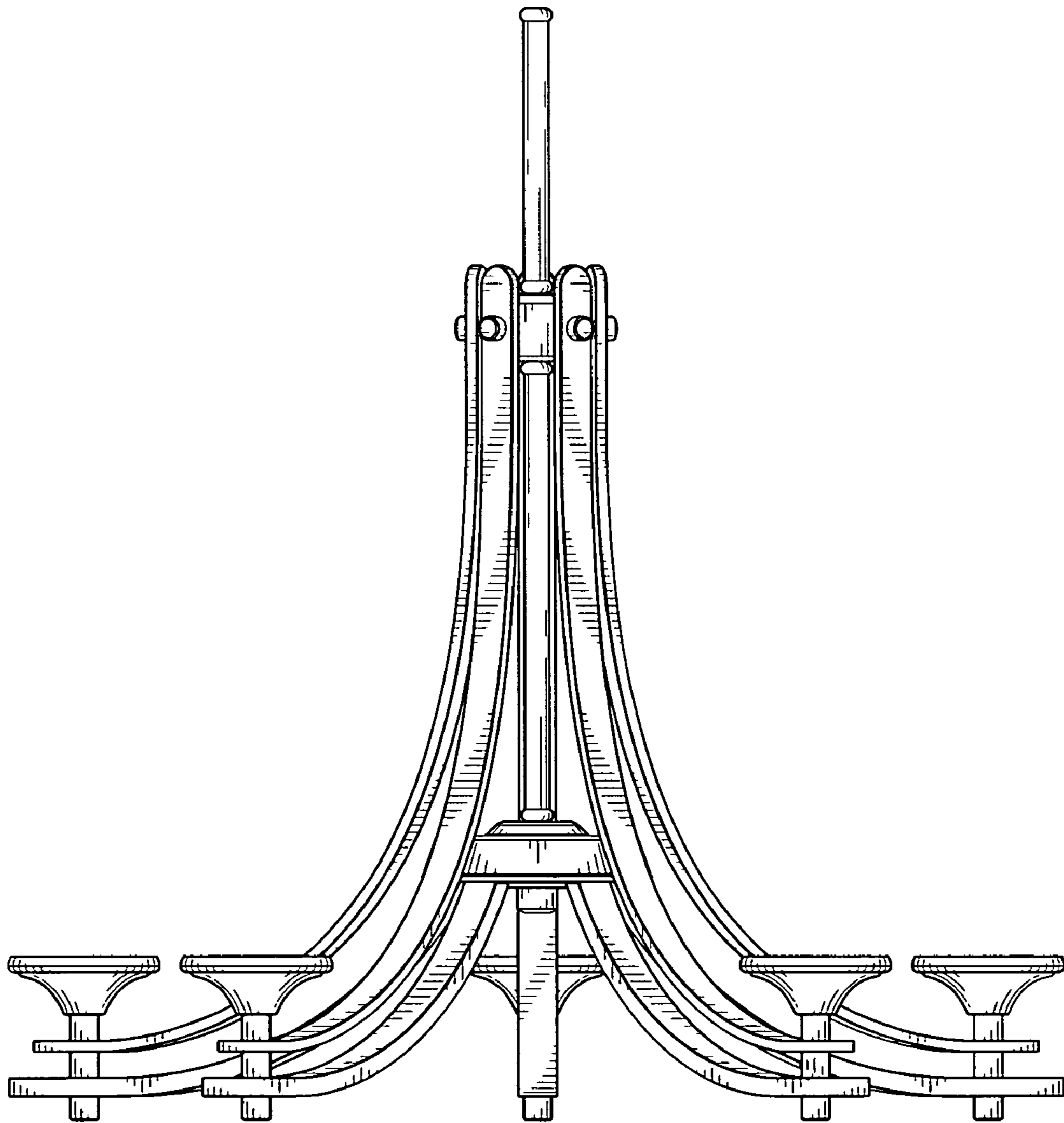

FIG. 3

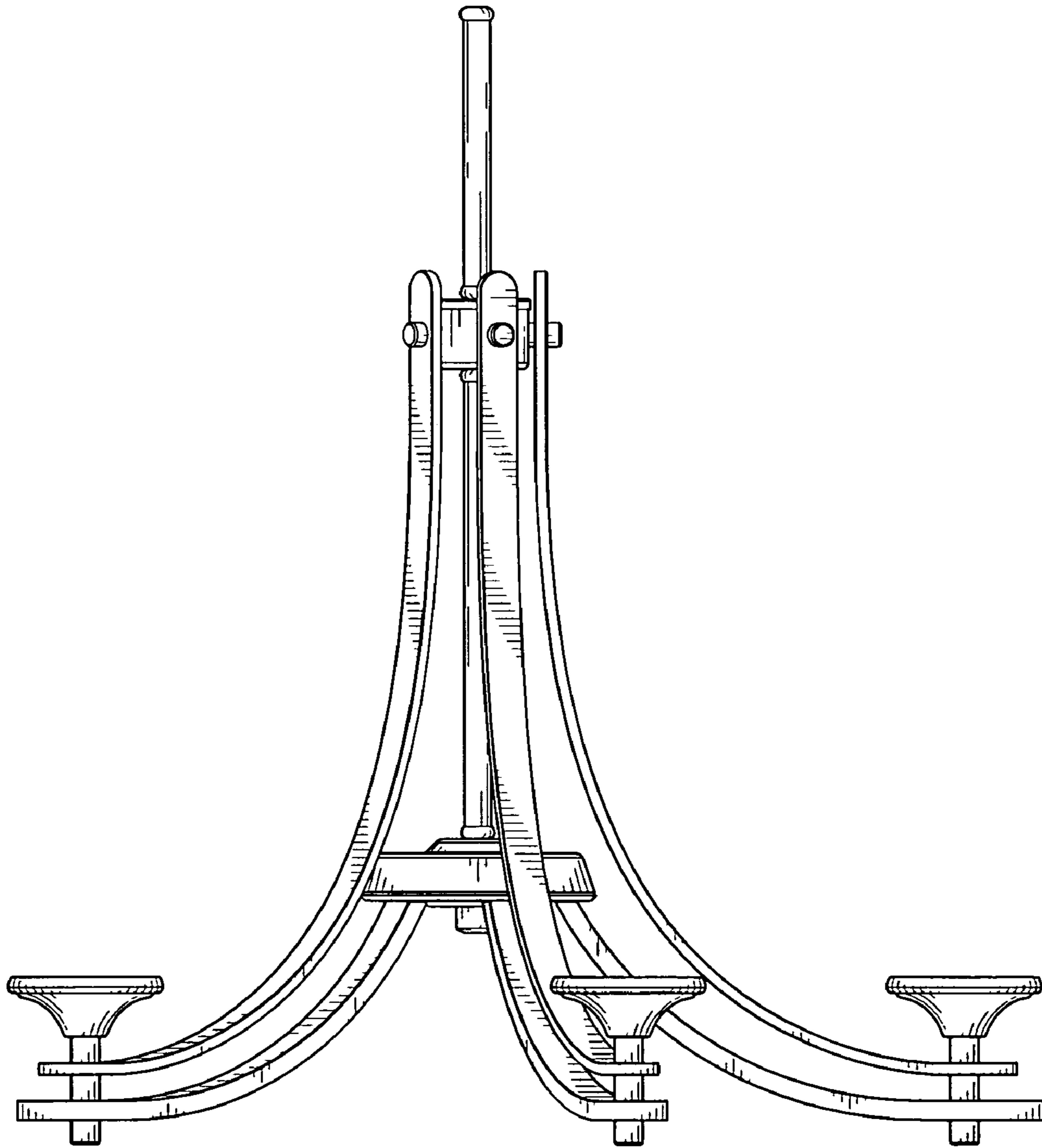

FIG. 4

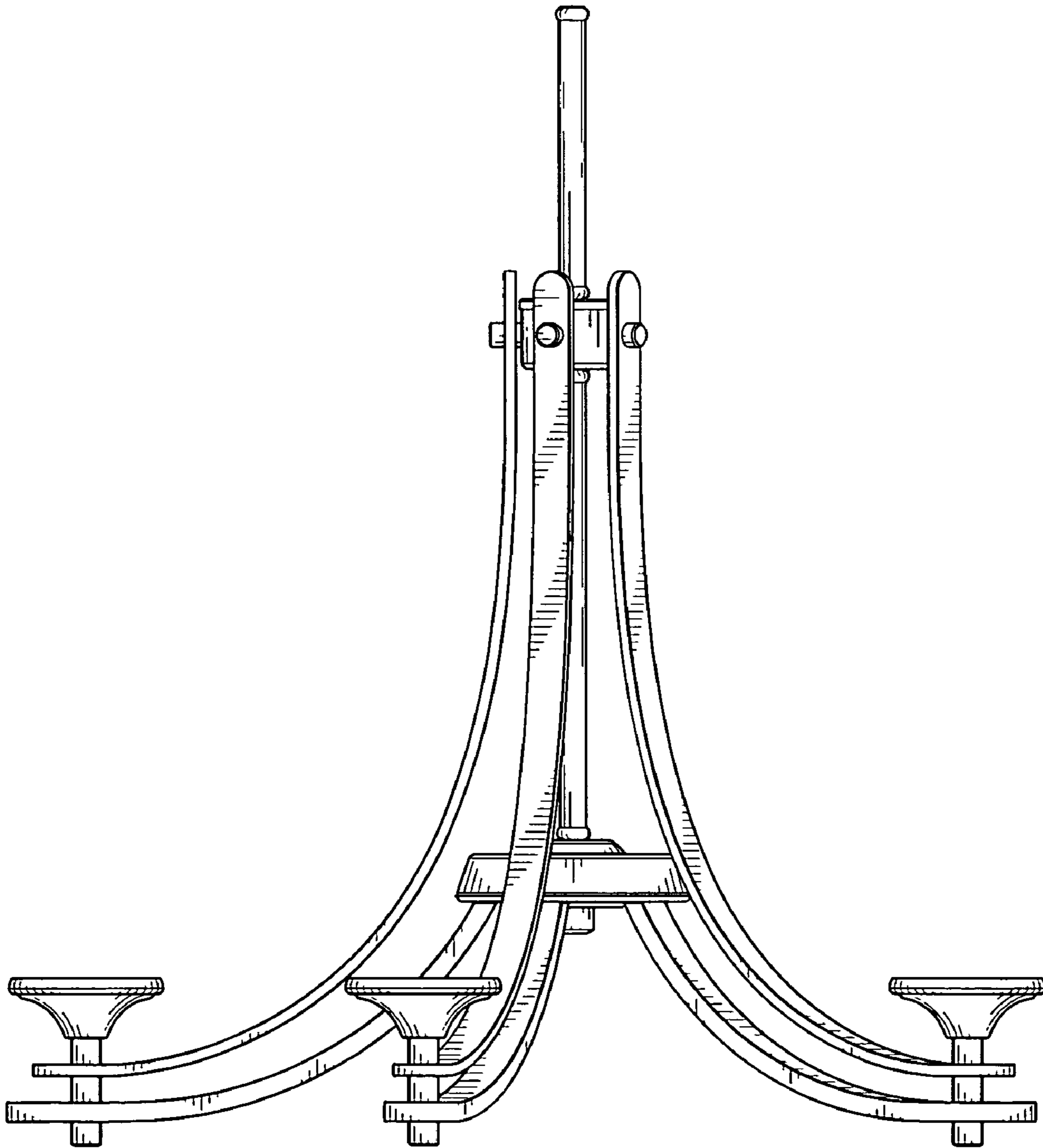

FIG. 5

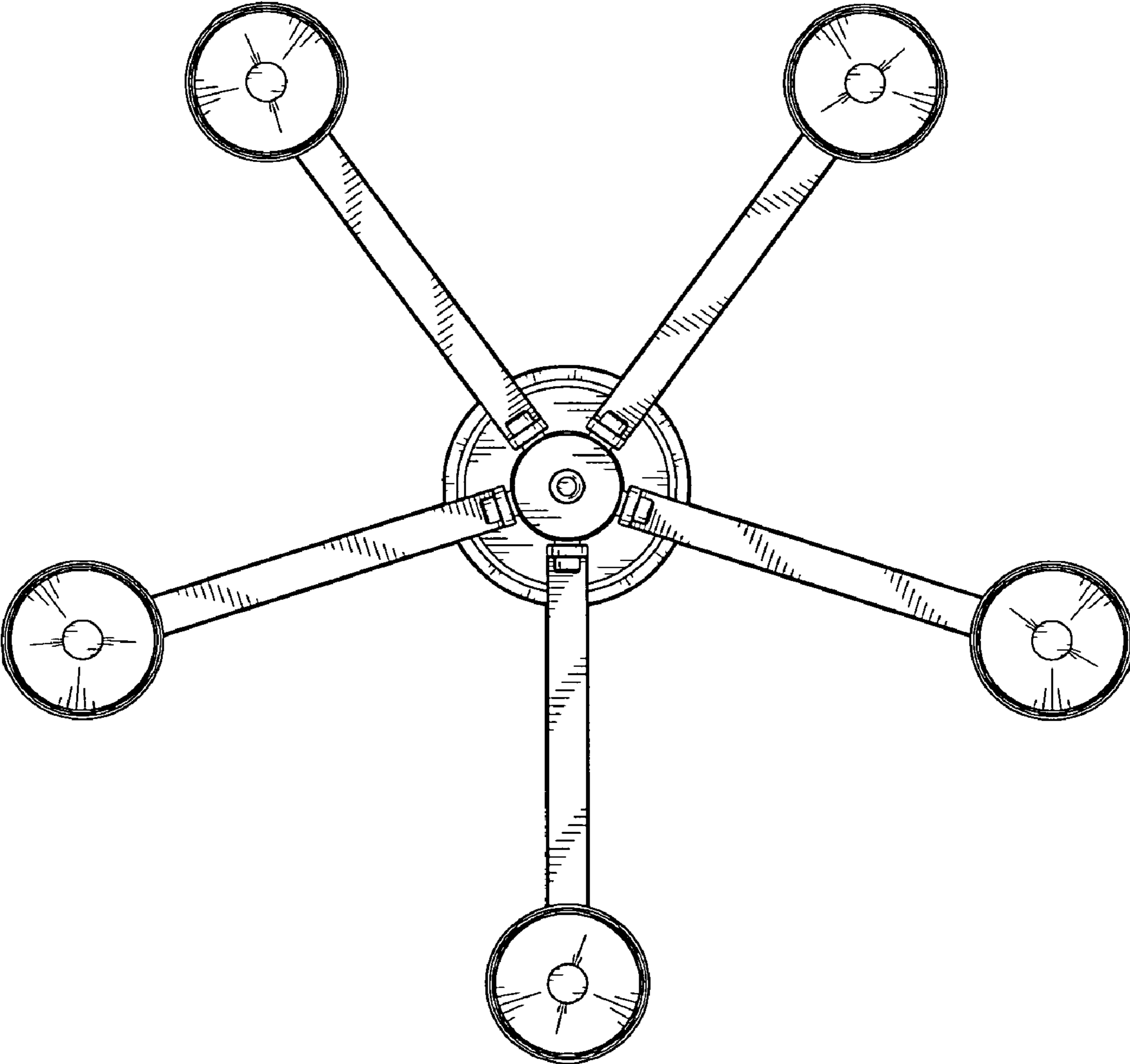

FIG. 6

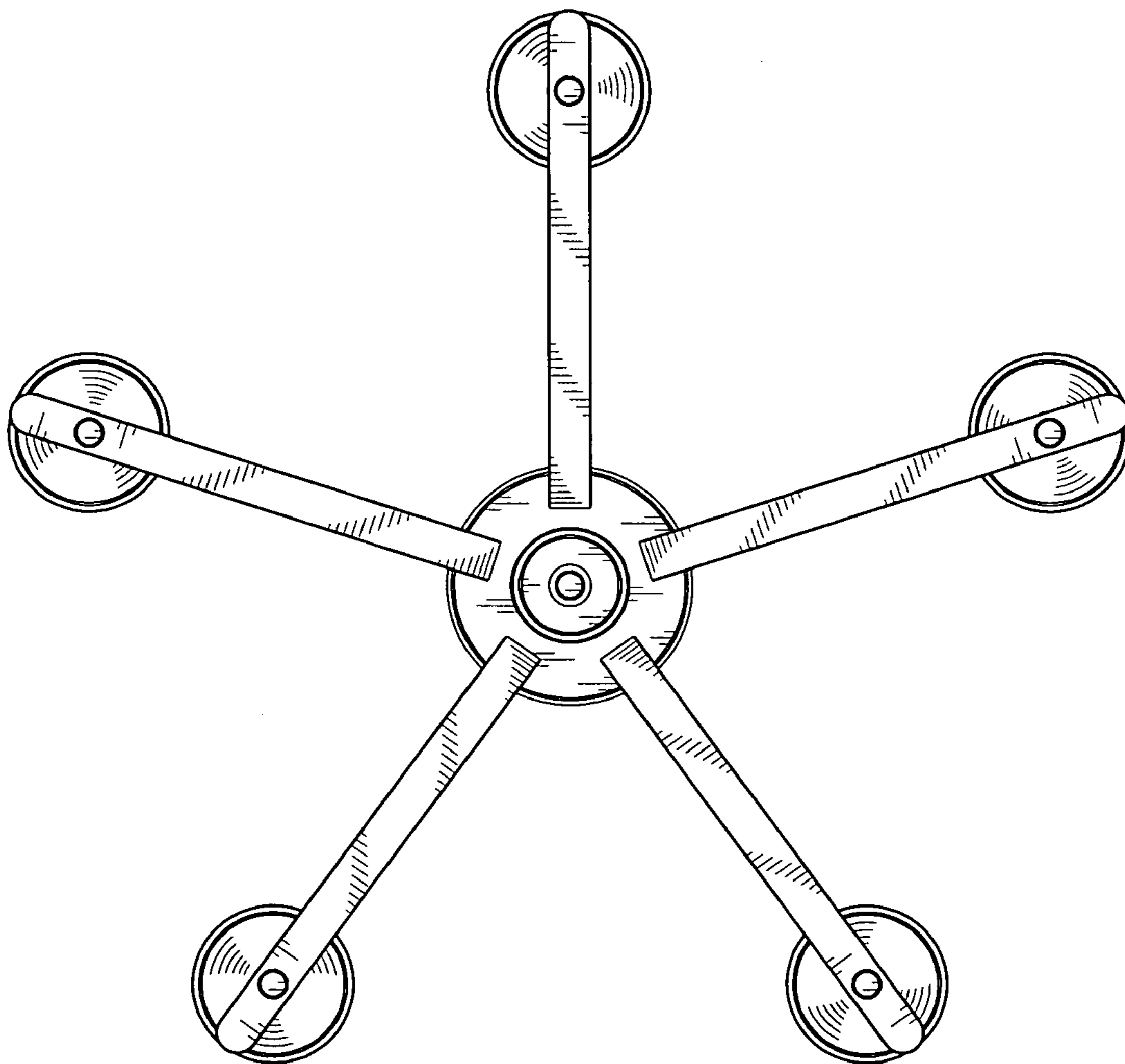

FIG. 7

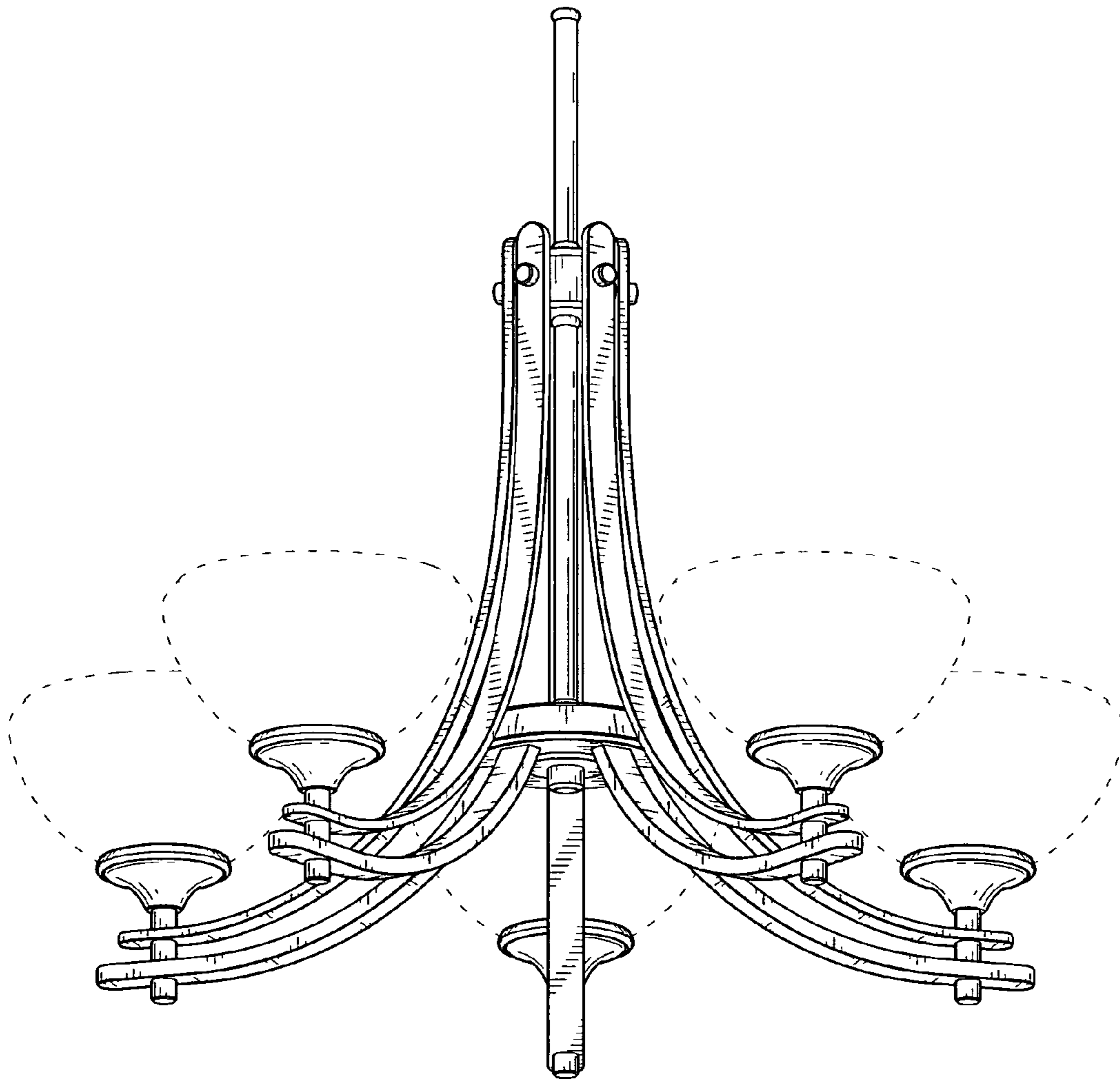

FIG. 8