



US00D578628S

(12) **United States Design Patent**
Yoo et al.

(10) **Patent No.:** **US D578,628 S**
(45) **Date of Patent:** **** Oct. 14, 2008**

(54) **AIR CONDITIONER**

(75) Inventors: **Joong Gil Yoo**, Seongnam-Si (KR); **Hee Jae Kwon**, Seoul (KR); **Min Ha Lee**, Gunpo-Si (KR); **Ji Young Yoon**, Yongin-Si (KR); **James Michael Wiggins**, Greensboro, NC (US)

(73) Assignee: **LG Electronics Inc.**, Seoul (KR)

(**) Term: **14 Years**

(21) Appl. No.: **29/290,674**

(22) Filed: **Jan. 2, 2008**

(30) **Foreign Application Priority Data**

Jul. 3, 2007 (KR) 30-2007-0028699

(51) **LOC (8) Cl.** **23-04**

(52) **U.S. Cl.** **D23/333**

(58) **Field of Classification Search** D6/314,
D6/317, 332-333, 351; 312/236; 62/259.1,
62/259.3, 259.4, 262-263, 304, 401, 515-516;
454/330-331, 349-350, 354

See application file for complete search history.

(56) **References Cited**

U.S. PATENT DOCUMENTS

D416,993 S * 11/1999 Dong et al. D23/333

D423,656 S * 4/2000 De'Longhi D23/333
D448,836 S * 10/2001 De' Longhi D23/333
D529,154 S * 9/2006 Koike D23/333
D548,313 S * 8/2007 Chiu D23/333
D549,307 S * 8/2007 Chiu D23/333
D549,308 S * 8/2007 Chiu D23/333
D556,309 S * 11/2007 Chiu D23/333

* cited by examiner

Primary Examiner—Brian N Vinson

(74) *Attorney, Agent, or Firm*—Morgan, Lewis & Bockius LLP

(57) **CLAIM**

The ornamental design for a air conditioner, as shown and described.

DESCRIPTION

FIG. 1 is a front, right perspective of the air conditioner showing my new design;

FIG. 2 is a front view thereof;

FIG. 3 is a rear view thereof;

FIG. 4 is a left side view thereof;

FIG. 5 is a right side view thereof;

FIG. 6 is a top plan view thereof; and,

FIG. 7 is a bottom plan view thereof.

1 Claim, 6 Drawing Sheets

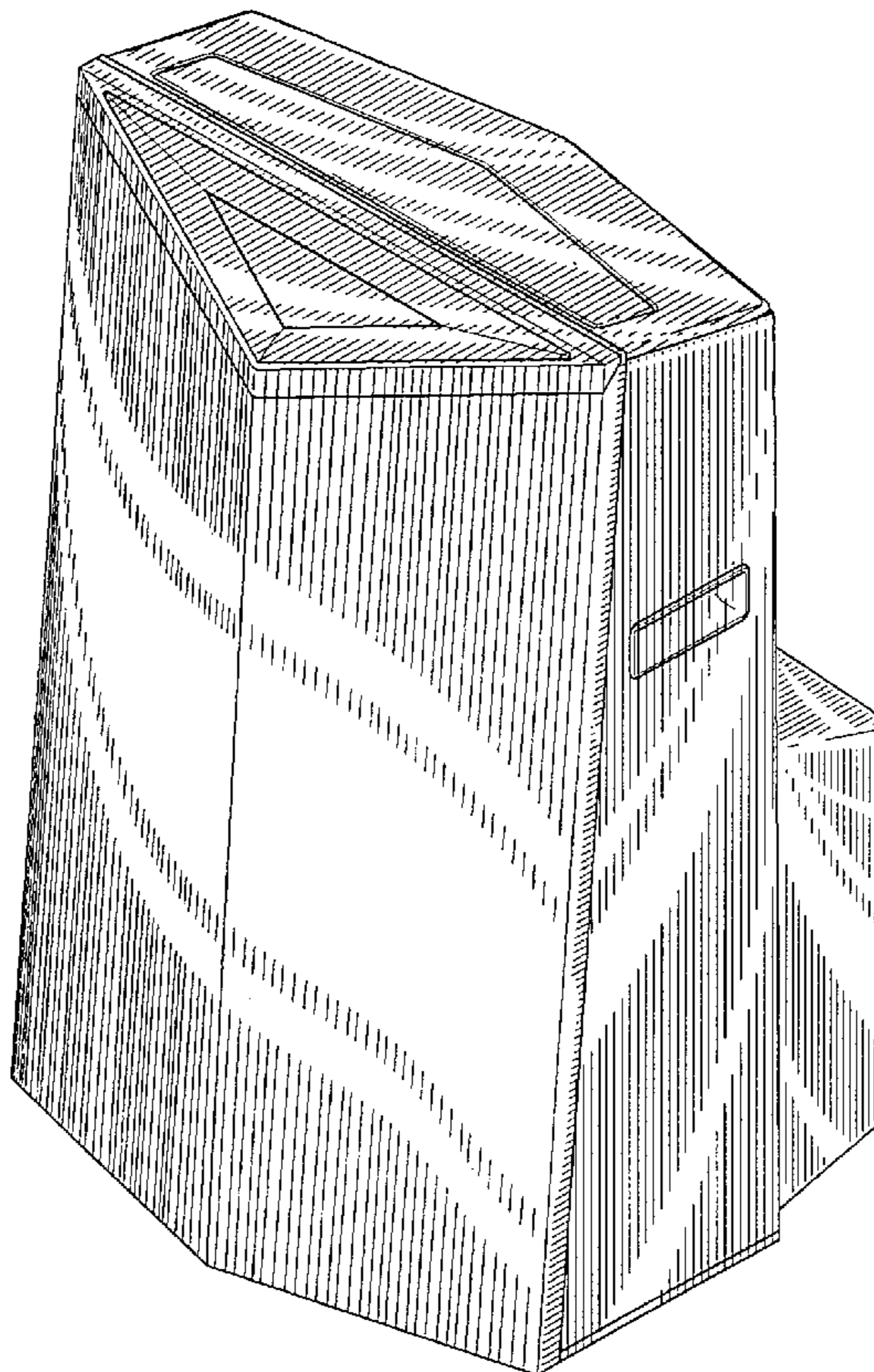

Fig.1

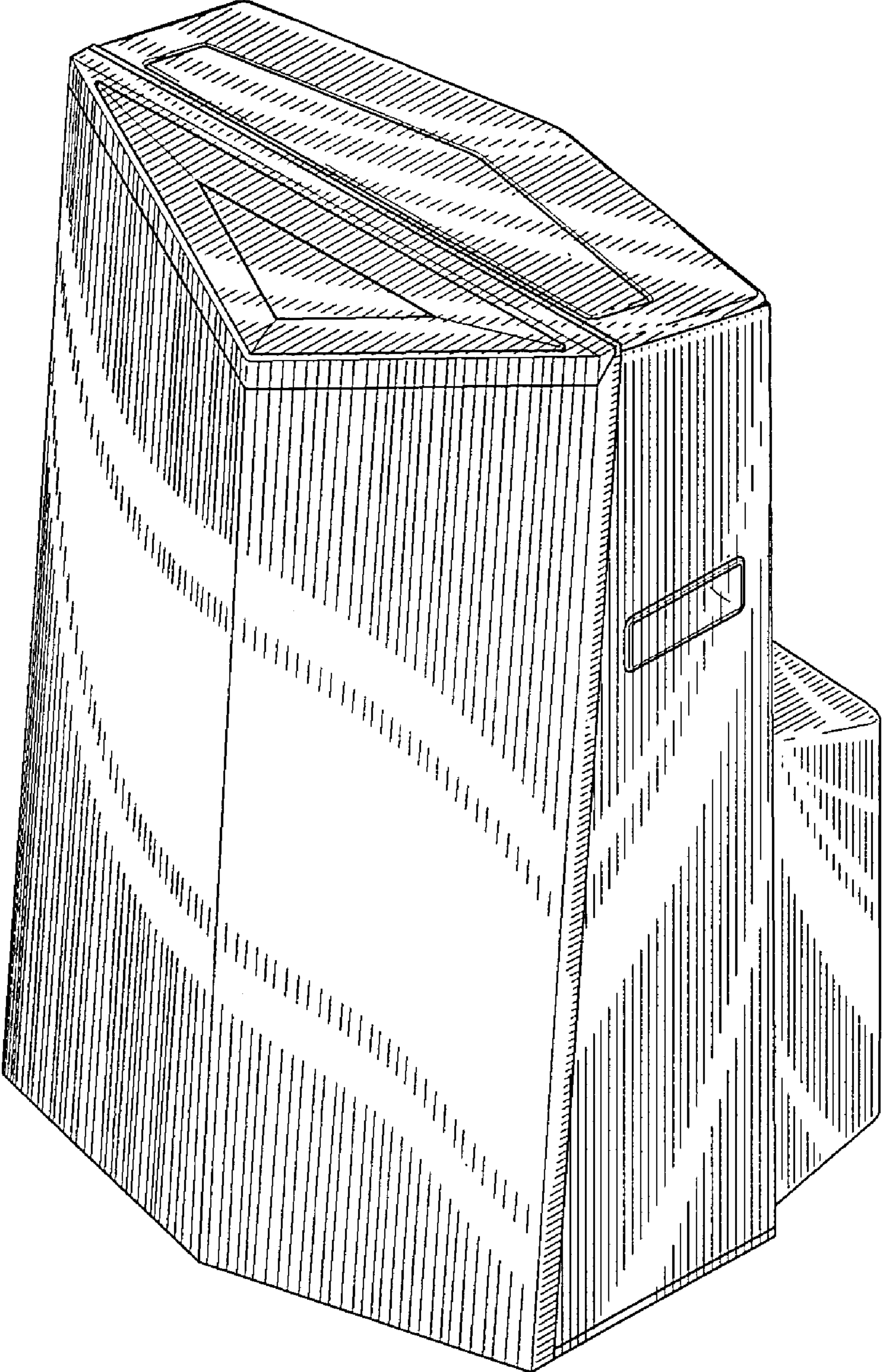

Fig.2

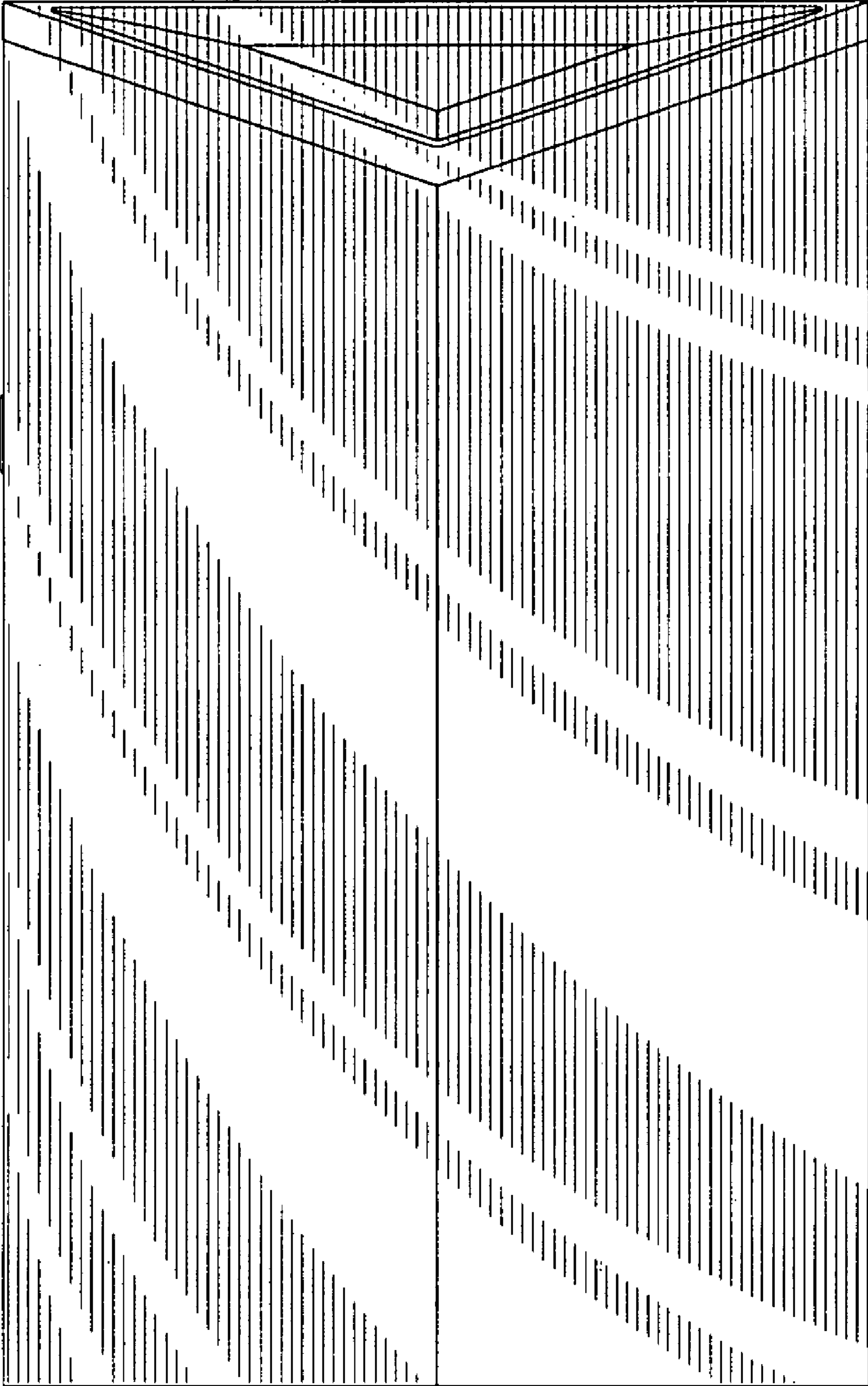

Fig.3

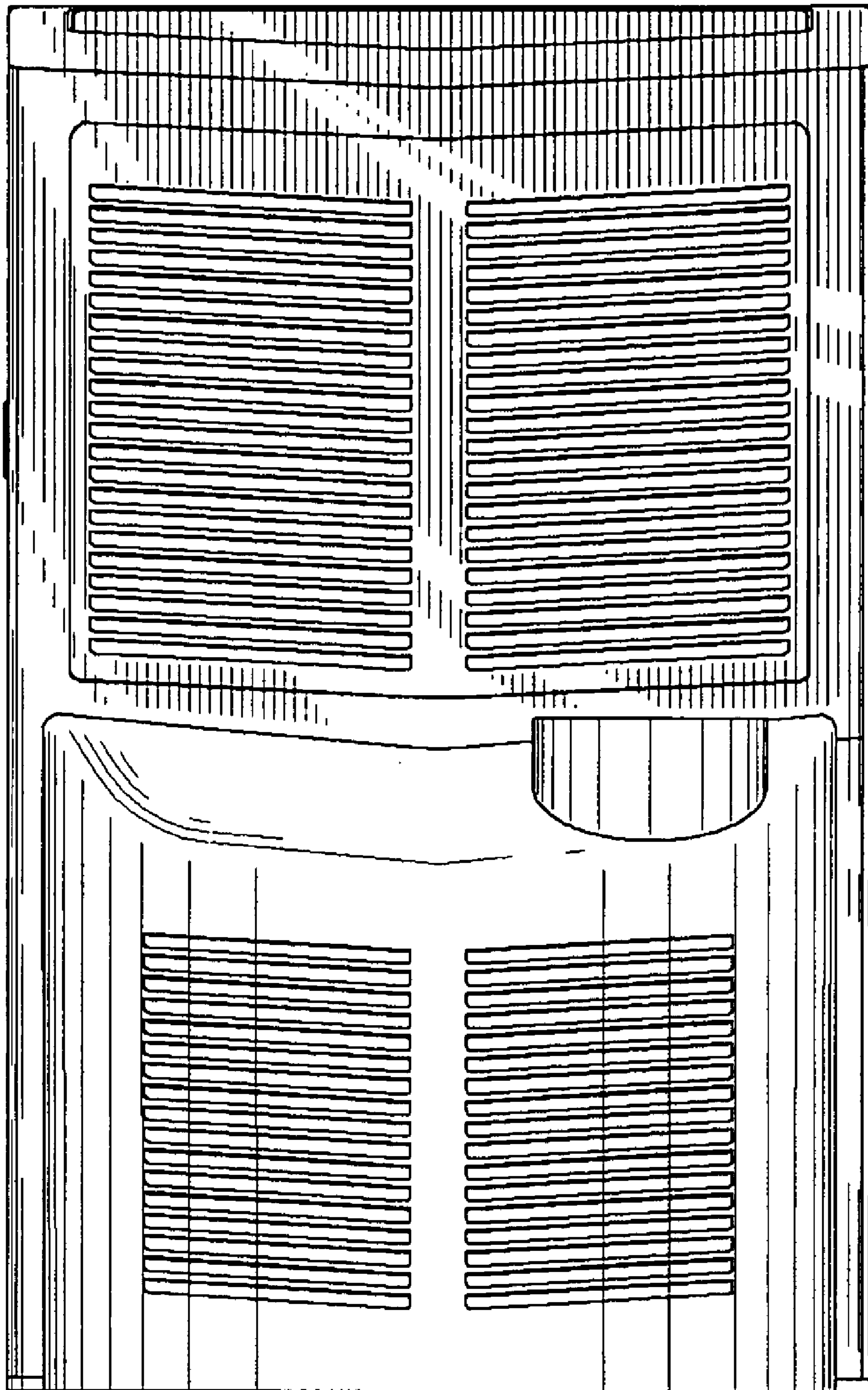

Fig.4

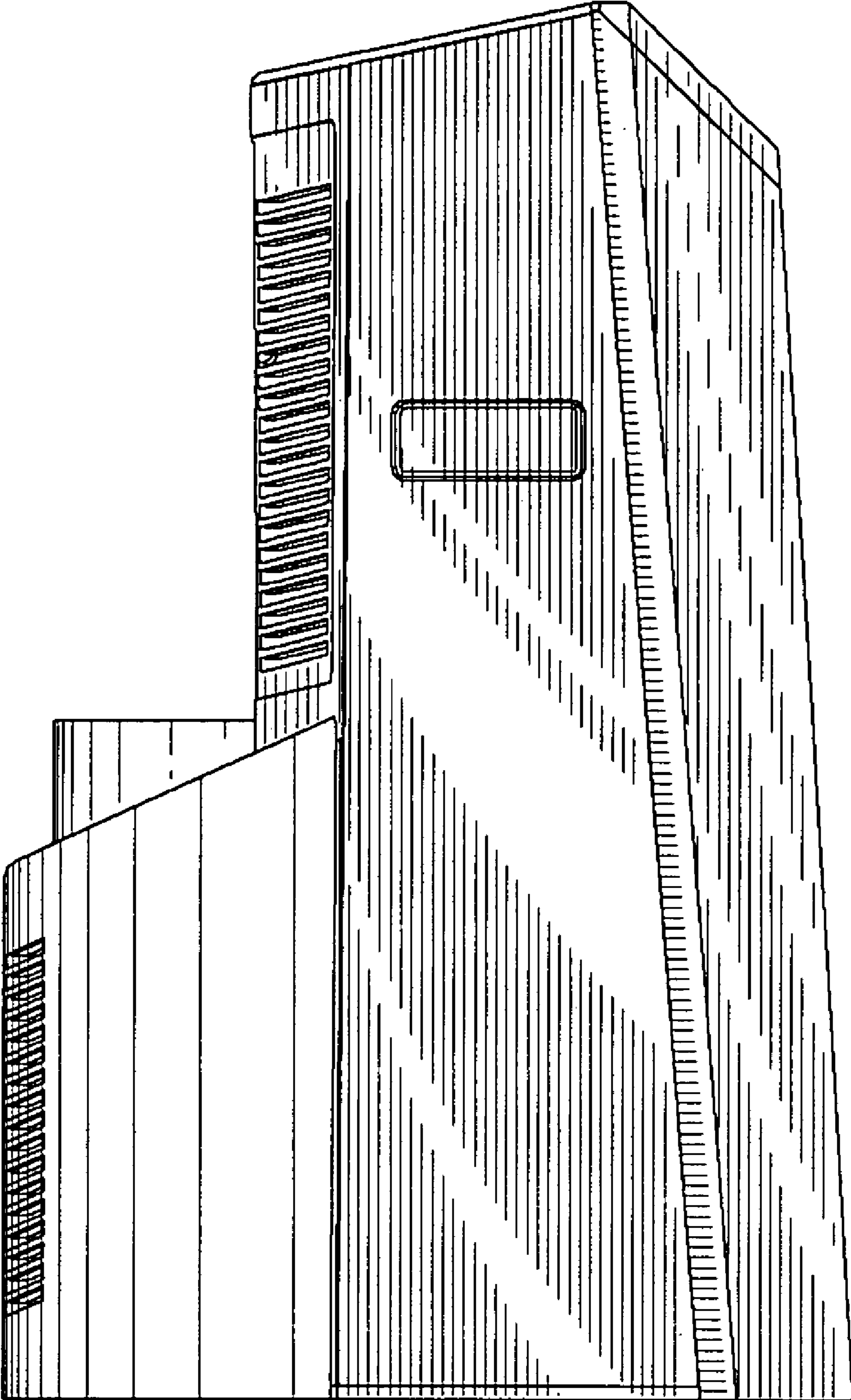

Fig.5

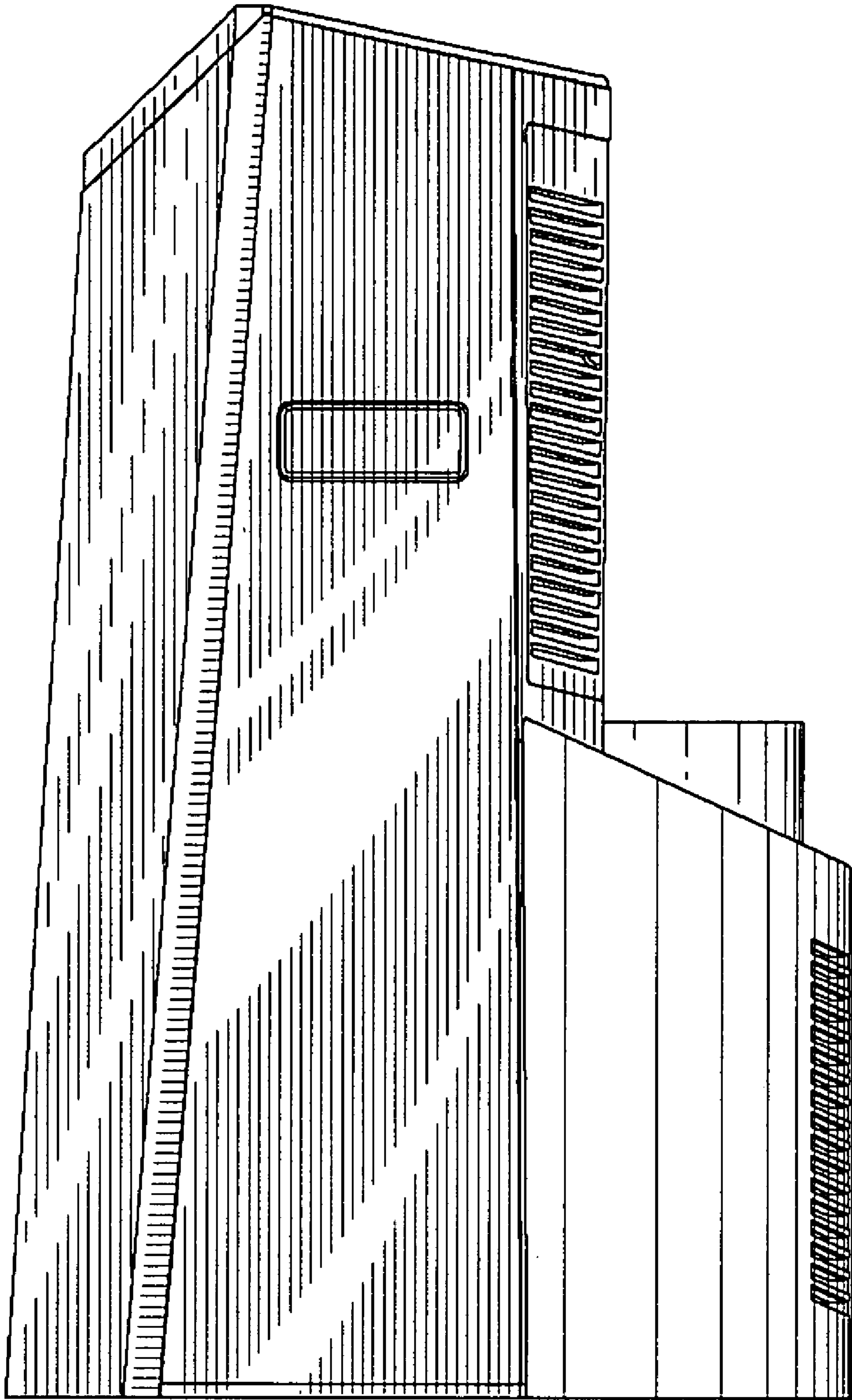

Fig.6

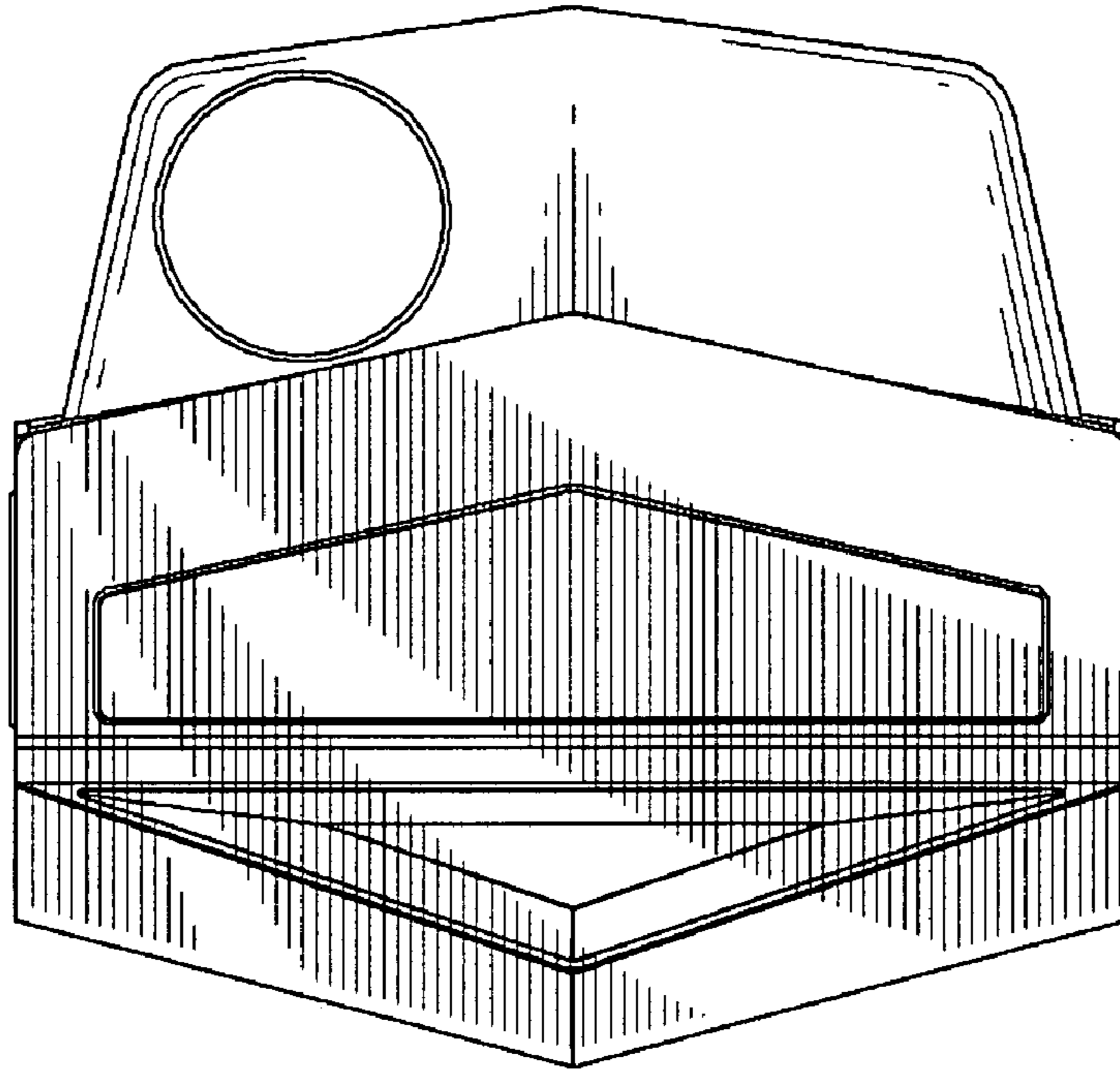

Fig.7

