



US00D578625S

(12) **United States Design Patent**
Ho

(10) **Patent No.:** **US D578,625 S**

(45) **Date of Patent:** **** Oct. 14, 2008**

(54) **TOILET CISTERN**

D559,367 S * 1/2008 Maruhashi D23/295

(75) Inventor: **Vincent Kai Hong Ho**, Croyden (AU)

* cited by examiner

(73) Assignee: **Caroma Industries Limited**, Brisbane, Queensland (AU)

Primary Examiner—Robert A Delehanty
(74) *Attorney, Agent, or Firm*—Merchant & Gould P.C.

(**) Term: **14 Years**

(57) **CLAIM**

(21) Appl. No.: **29/271,678**

The ornamental design for a toilet cistern, as shown and described.

(22) Filed: **Jan. 24, 2007**

DESCRIPTION

(51) **LOC (8) Cl.** **23-02**

(52) **U.S. Cl.** **D23/313**

(58) **Field of Classification Search** D23/295,
D23/301, 303, 309, 313; 4/664, 300, 353
See application file for complete search history.

FIG. 1 is a Top View showing our new design;

FIG. 2 is a Left Side View thereof;

FIG. 3 is a Front View thereof;

FIG. 4 is a Right View thereof;

FIG. 5 is a Back View thereof;

FIG. 6 is a Bottom View thereof; and,

FIG. 7 is an Isometric View thereof.

(56) **References Cited**

U.S. PATENT DOCUMENTS

- D269,202 S * 5/1983 Thompson D23/313
- D350,188 S * 8/1994 McNeill D23/313
- D521,131 S * 5/2006 Hou D23/313

1 Claim, 1 Drawing Sheet

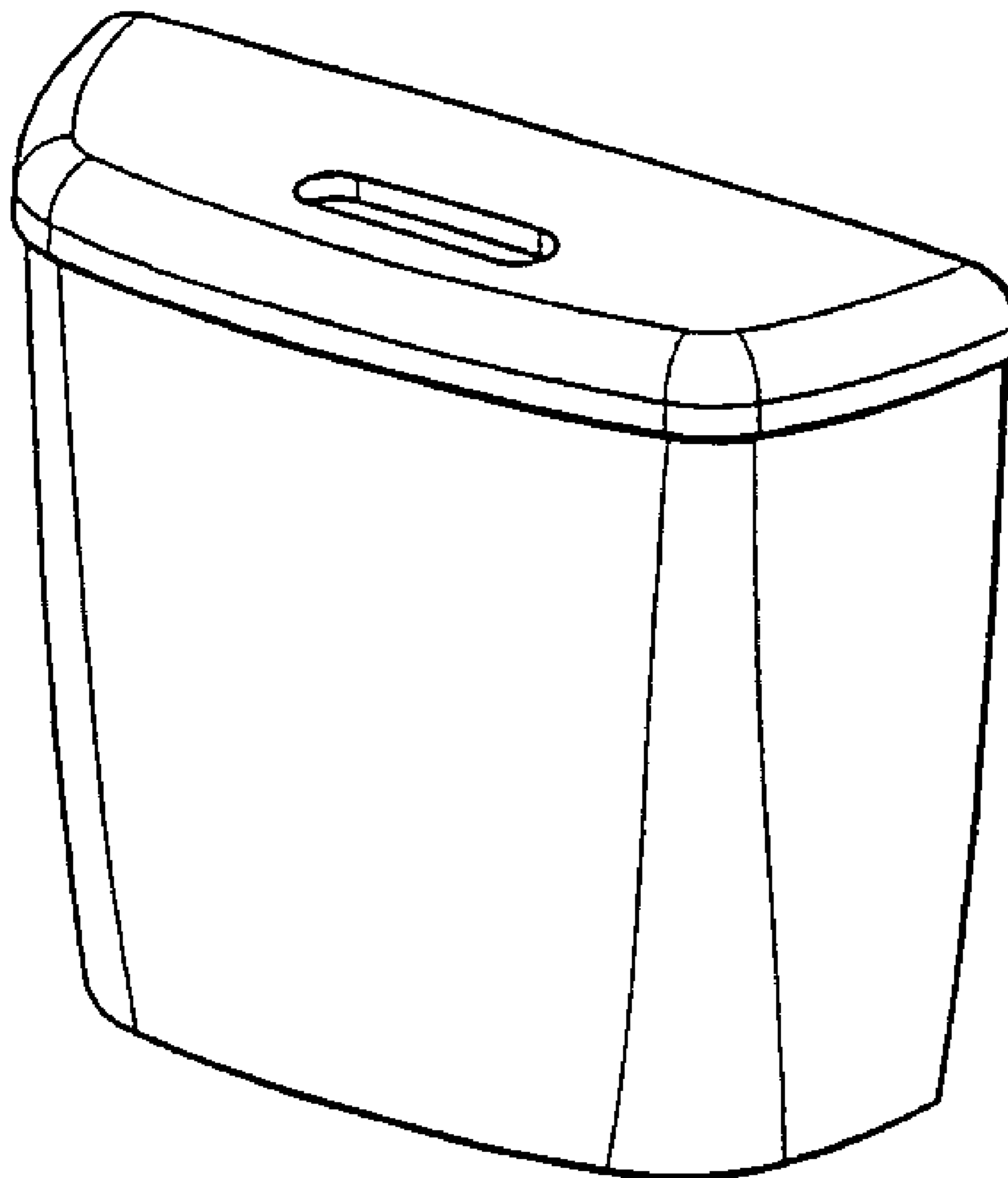

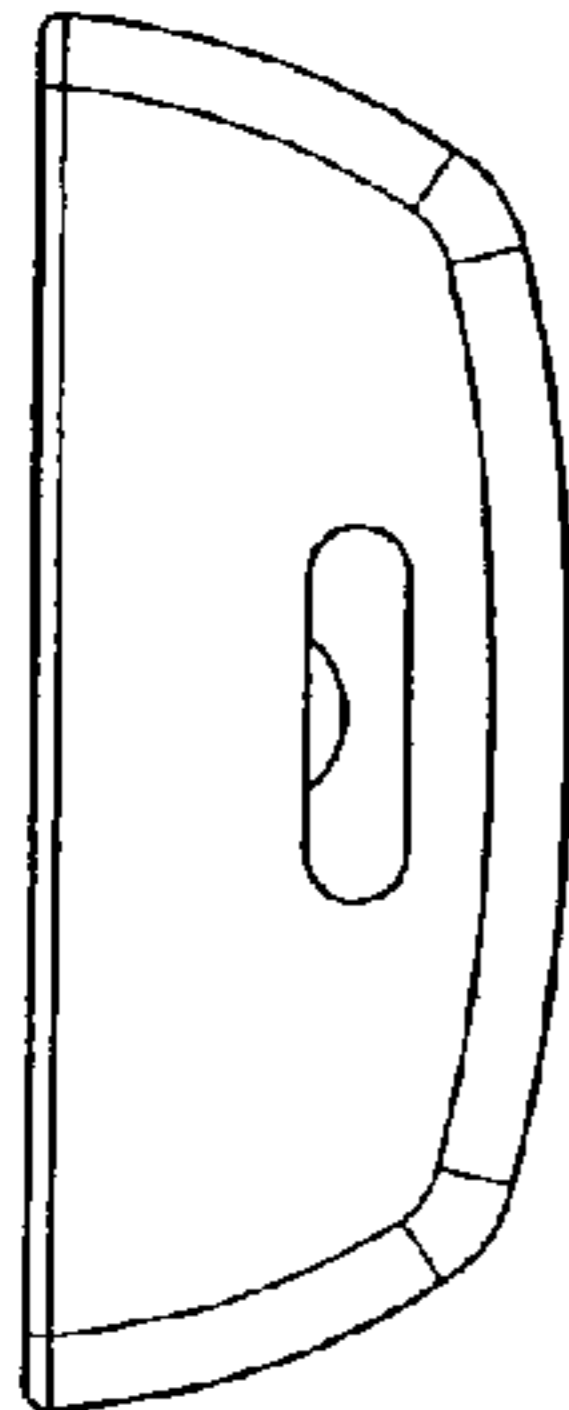

FIG. 1

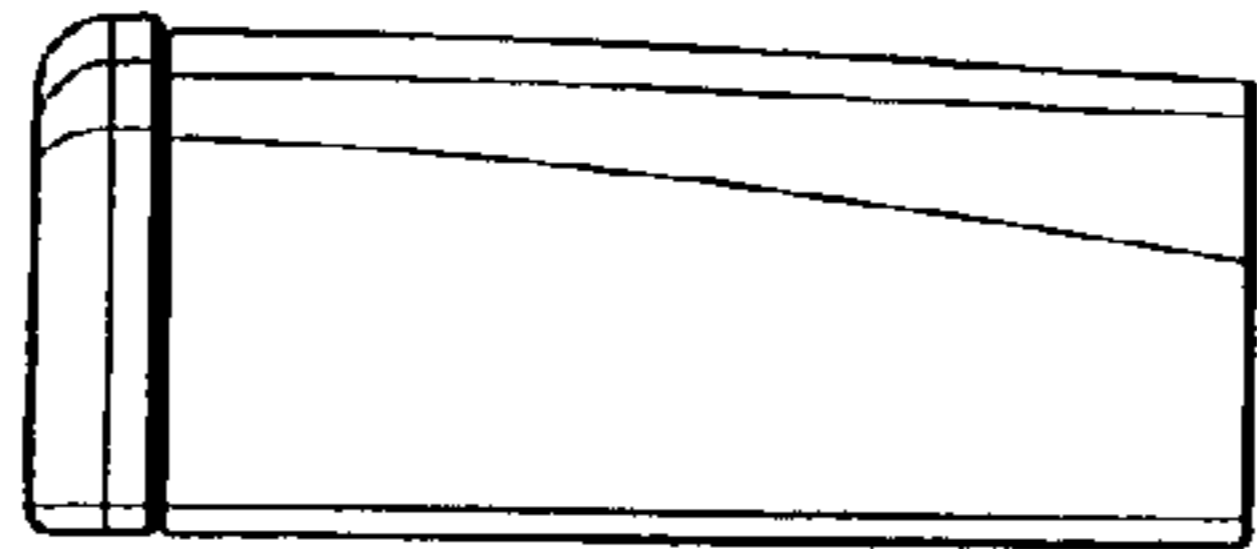

FIG. 2

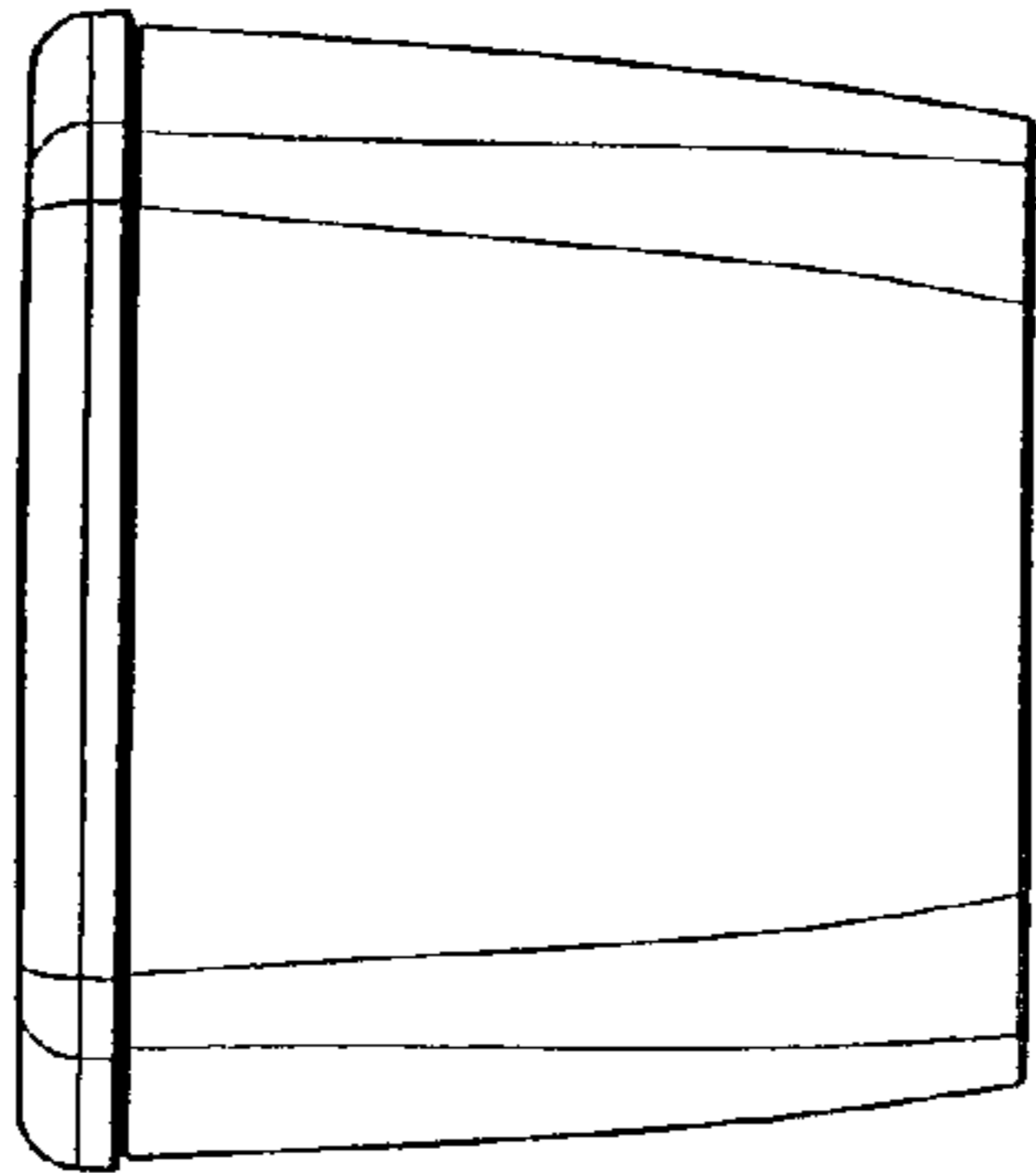

FIG. 3

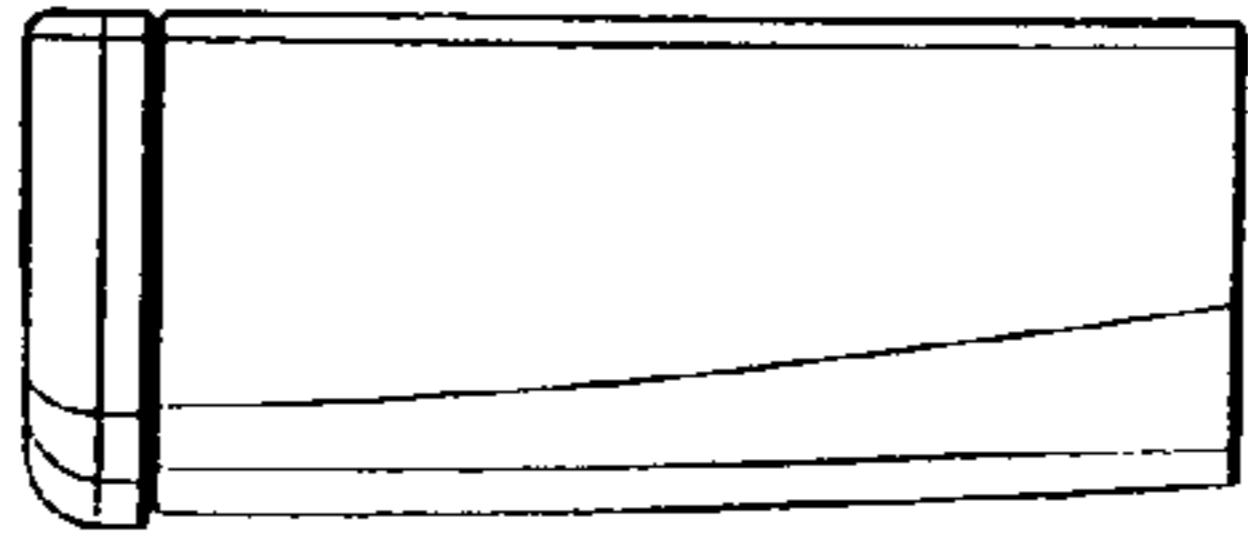

FIG. 4

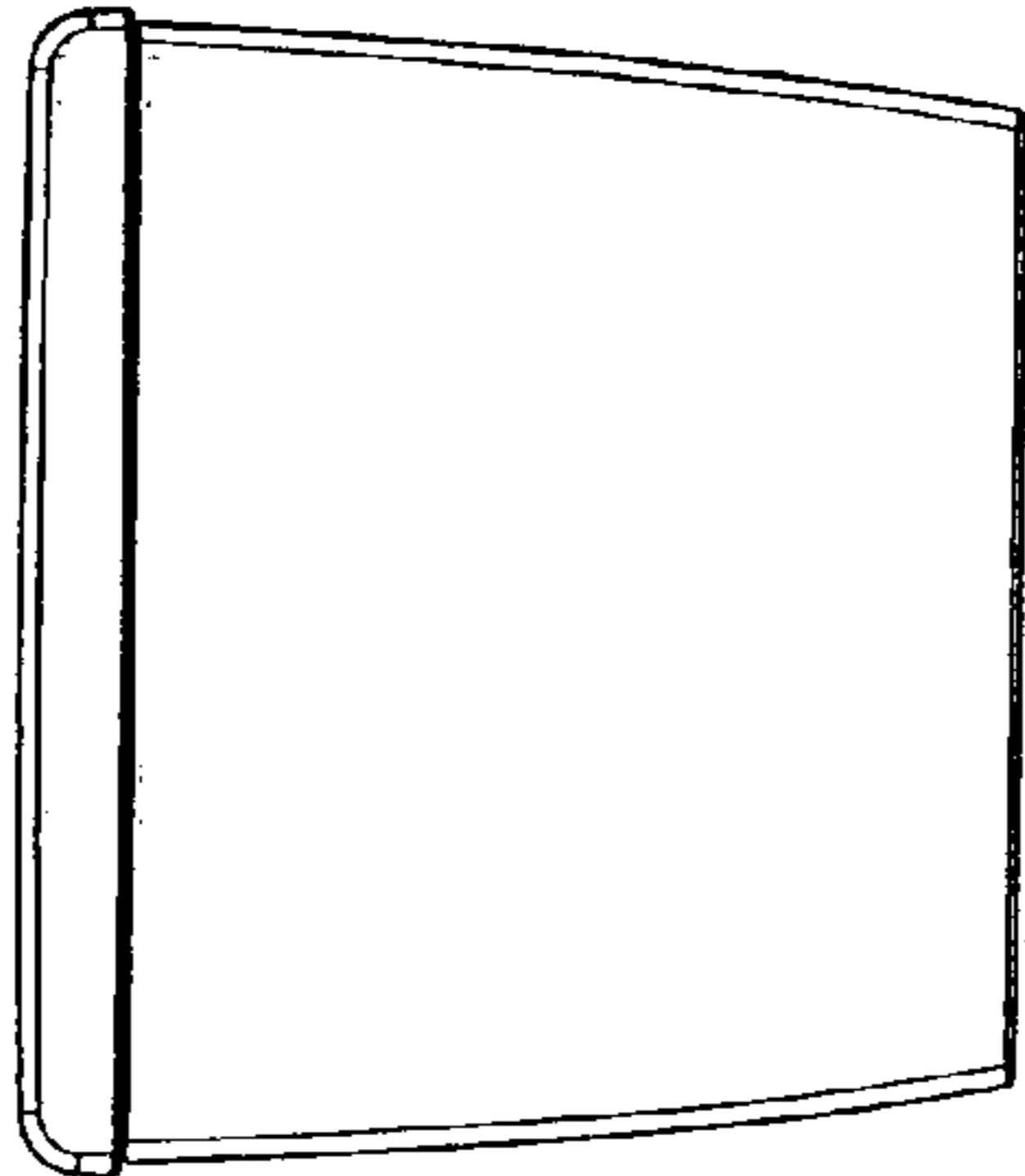

FIG. 5

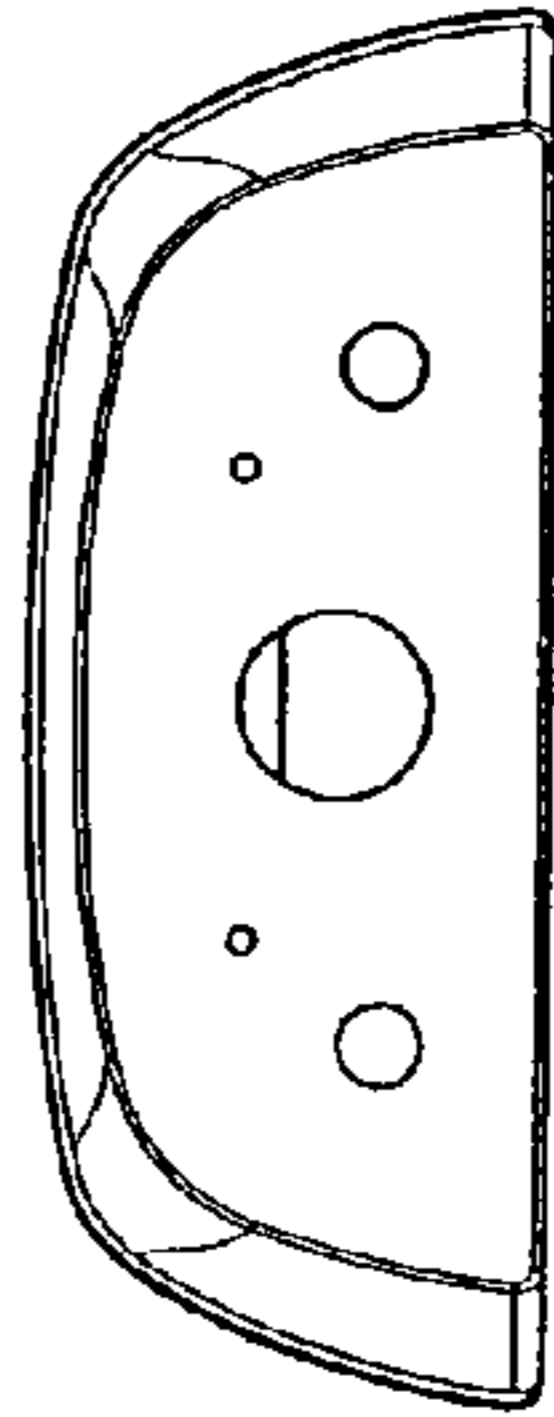

FIG. 6

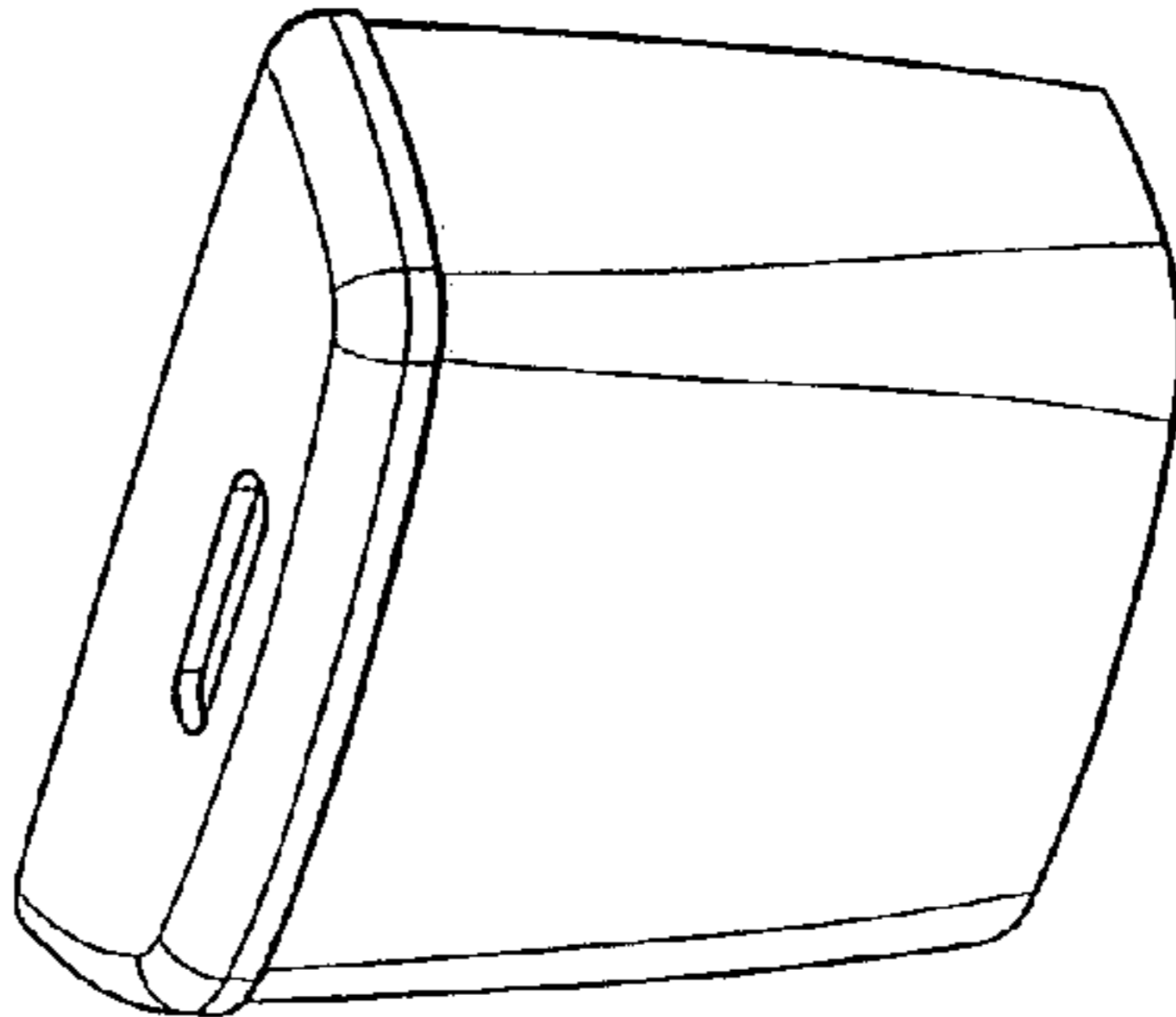

FIG. 7

UNITED STATES PATENT AND TRADEMARK OFFICE
CERTIFICATE OF CORRECTION

PATENT NO. : Des. 578,625 S
APPLICATION NO. : 29/271678
DATED : October 14, 2008
INVENTOR(S) : Ho

Page 1 of 1

It is certified that error appears in the above-identified patent and that said Letters Patent is hereby corrected as shown below:

Title page, item [30], insert omitted Foreign Priority Data:
--(30) Foreign Application Priority Data
Aug. 18, 2006 (AU) 13689/2006--

Signed and Sealed this

Seventeenth Day of February, 2009



JOHN DOLL
Acting Director of the United States Patent and Trademark Office