



US00D578606S

(12) **United States Design Patent**
Wu et al.

(10) **Patent No.:** **US D578,606 S**
(45) **Date of Patent:** **** Oct. 14, 2008**

(54) **HAND SHOWER**

D550,811 S * 9/2007 Lammel D23/223
D560,753 S * 1/2008 Chung D23/223
D562,942 S * 2/2008 Pan D23/223

(76) Inventors: **James Wu**, NO15, Lane 160, Fongfu Rd., Taichung (TW); **Alex Wu**, NO15, Lane 160, Fongfu Rd., Taichung (TW)

* cited by examiner

(**) Term: **14 Years**

Primary Examiner—Robin V Webster
(74) *Attorney, Agent, or Firm*—Pro-Techtor Int'l Services

(21) Appl. No.: **29/294,800**

(57) **CLAIM**

(22) Filed: **Jan. 29, 2008**

The ornamental design for a hand shower, as shown and described.

(51) **LOC (8) Cl.** **23-01**

(52) **U.S. Cl.** **D23/223**

(58) **Field of Classification Search** D23/213,
D23/223, 229–230; 239/394, 282–283
See application file for complete search history.

DESCRIPTION

(56) **References Cited**

U.S. PATENT DOCUMENTS

D424,162 S * 5/2000 Haug et al. D23/223
D428,110 S * 7/2000 Haug et al. D23/223
D506,243 S * 6/2005 Wu D23/223
D526,384 S * 8/2006 Wu D23/223
D547,420 S * 7/2007 Lobermeier D23/223
D547,521 S * 7/2007 Perrier et al. D34/27
D550,810 S * 9/2007 Lammel D23/223

FIG. 1. is a front-right-top perspective view of a hand shower, showing my new design;
FIG. 2. is a front elevational view thereof;
FIG. 3. is a rear elevational view thereof;
FIG. 4. is a left side elevational view thereof;
FIG. 5. is a right side elevational view thereof;
FIG. 6. is a top plan view thereof; and,
FIG. 7. is a bottom plan view thereof.

1 Claim, 7 Drawing Sheets

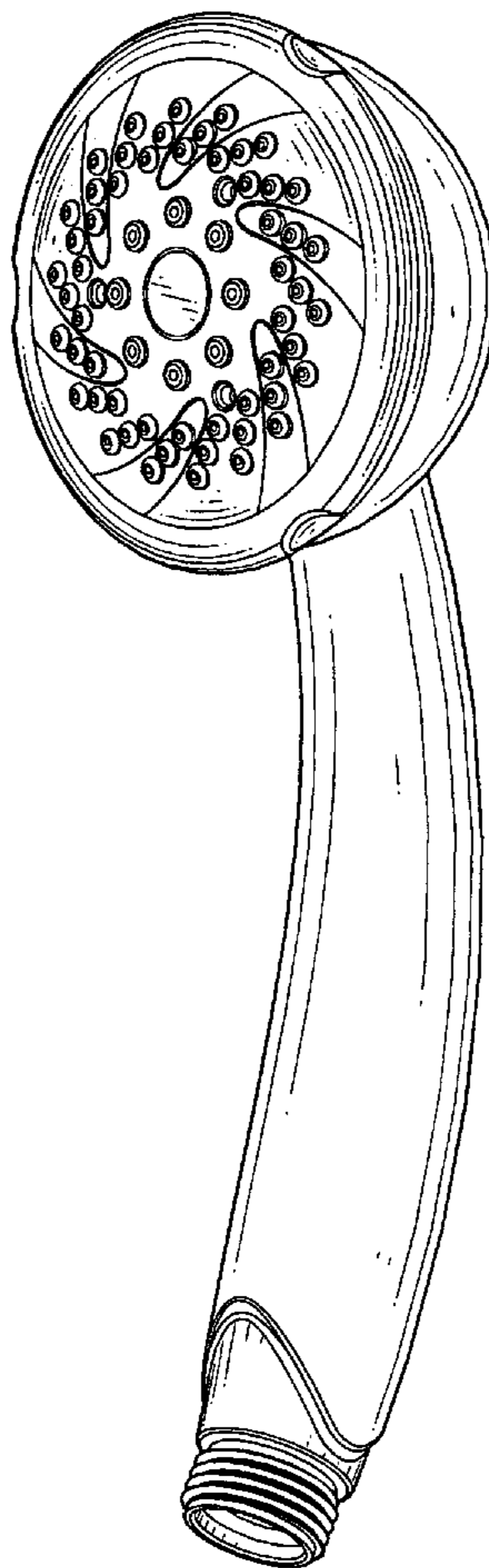

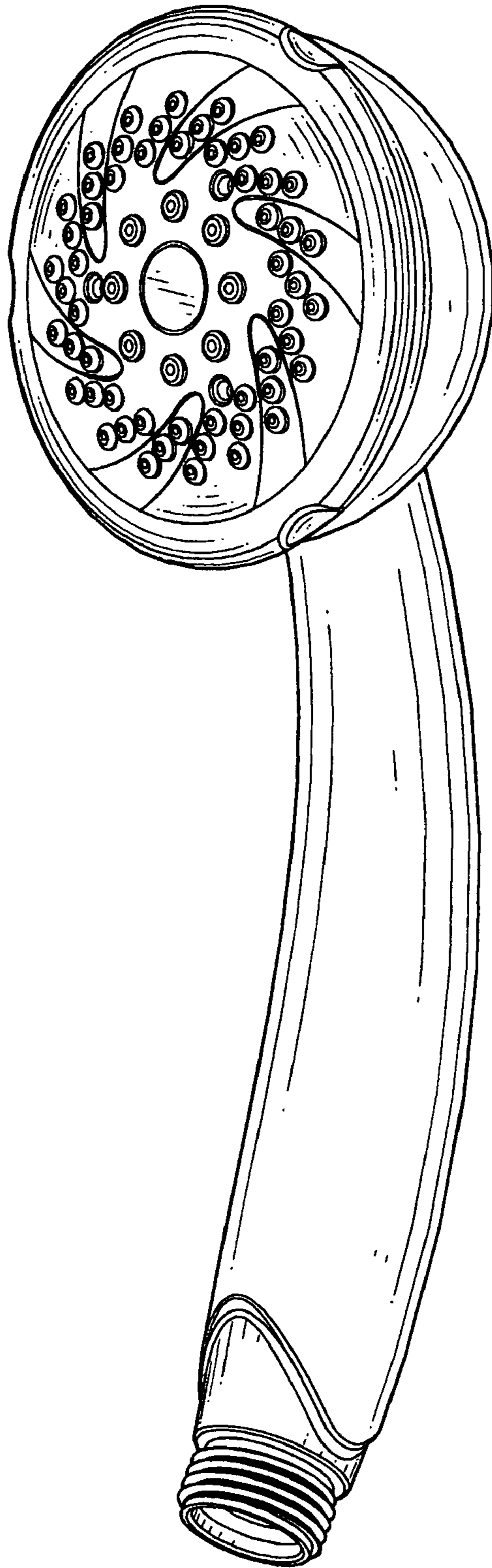

FIG. 1

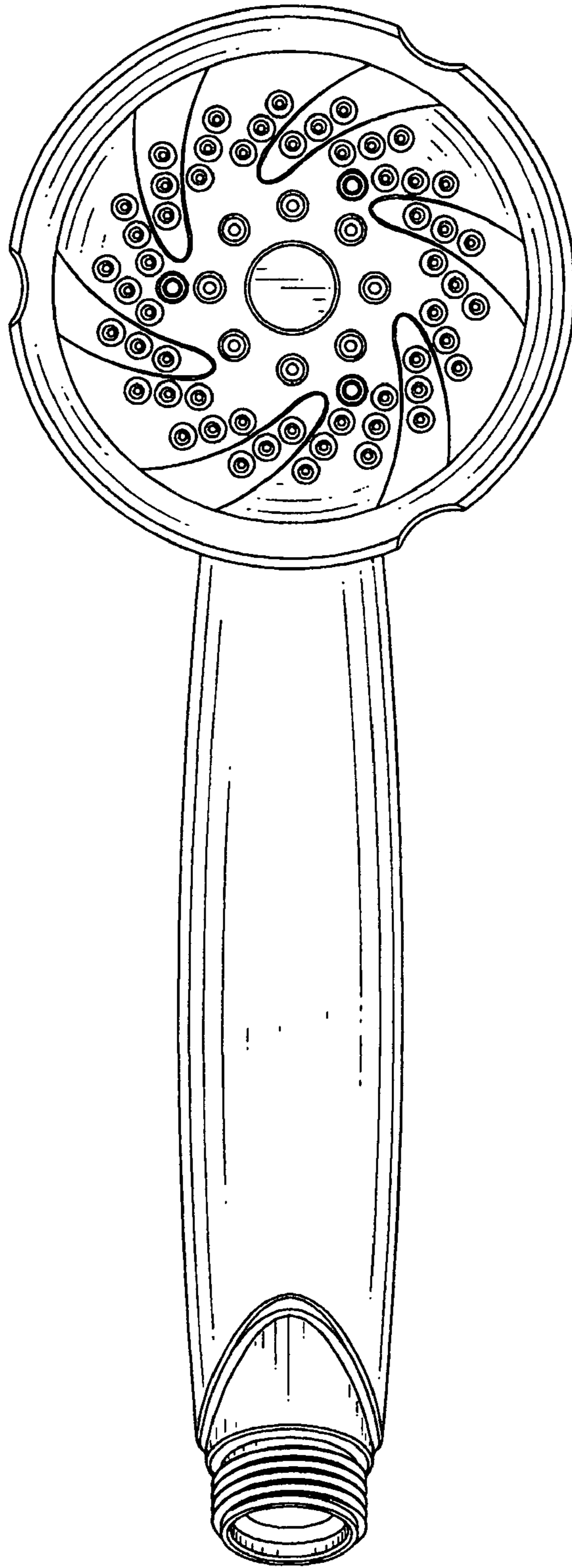

FIG. 2

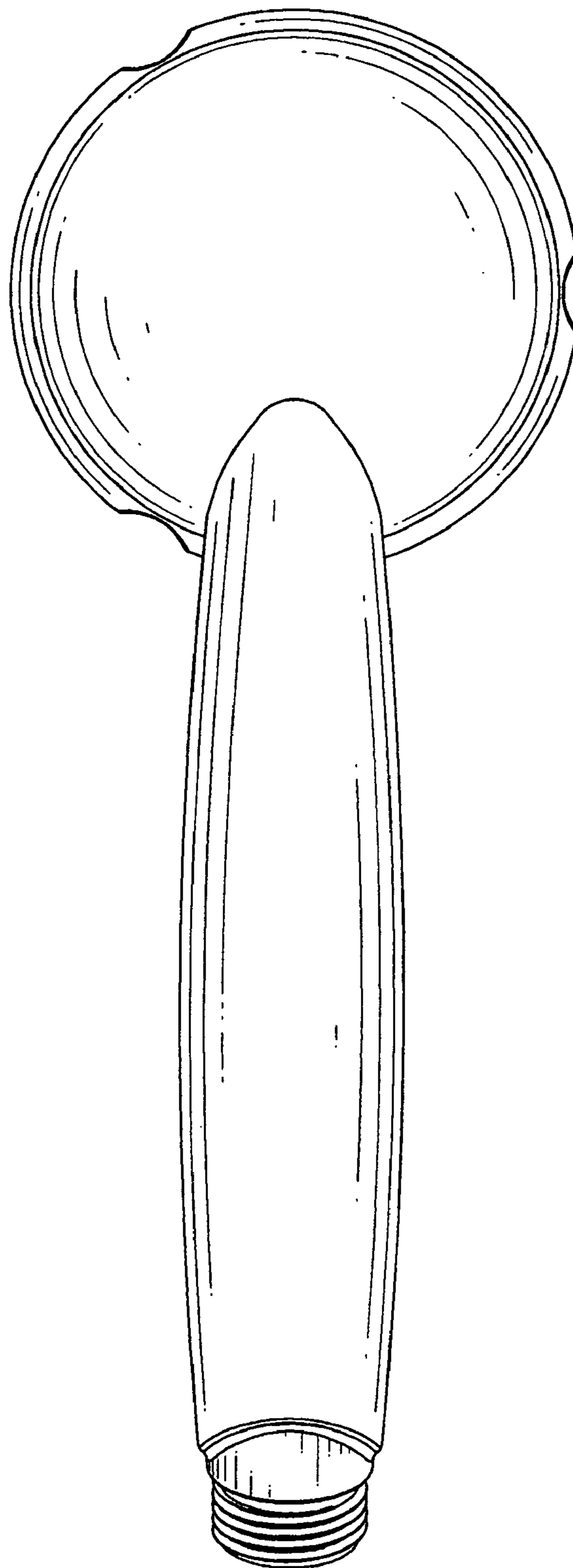

FIG. 3



FIG. 4

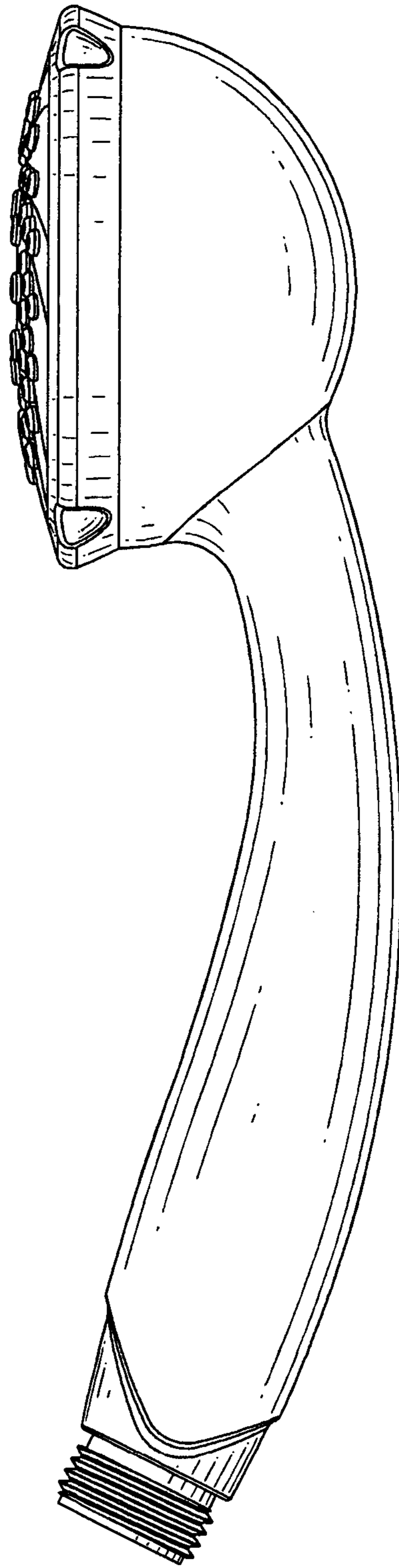

FIG. 5

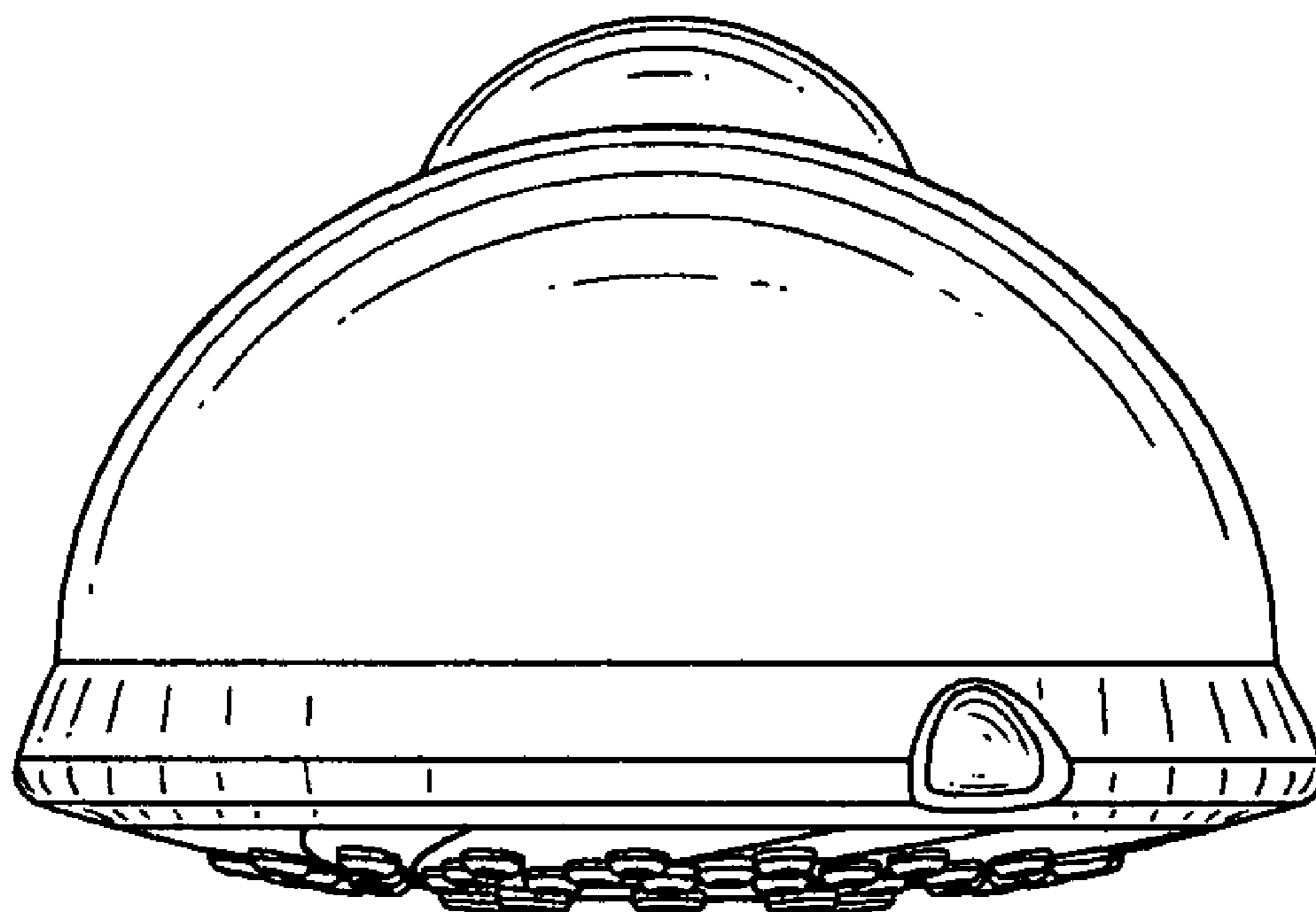

FIG. 6

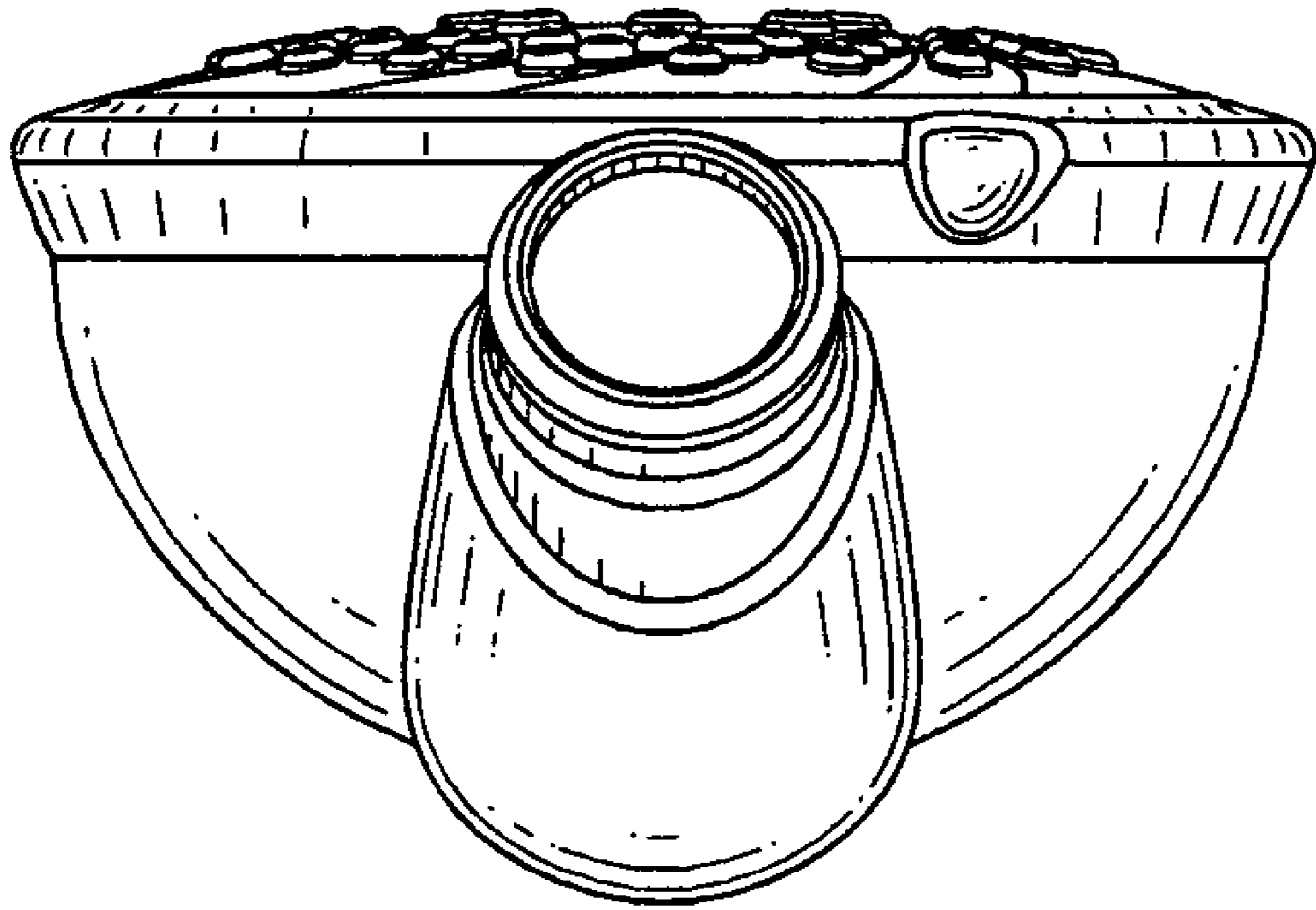

FIG. 7