



US00D578556S

(12) **United States Design Patent**
Choi

(10) **Patent No.:** **US D578,556 S**
(45) **Date of Patent:** **** Oct. 14, 2008**

(54) **REFRIGERATOR**
(75) Inventor: **Kyu Kwan Choi**, Seoul (KR)
(73) Assignee: **LG Electronics Inc.**, Seoul (KR)
(**) Term: **14 Years**

D528,135 S * 9/2006 Kim et al. D15/85
D544,002 S * 6/2007 Kim et al. D15/85
D551,260 S * 9/2007 Kim et al. D15/85
D567,260 S * 4/2008 Kim et al. D15/85
D568,343 S * 5/2008 Suh et al. D15/85

* cited by examiner

(21) Appl. No.: **29/290,823**
(22) Filed: **Jan. 17, 2008**

Primary Examiner—Stella M. Reid
Assistant Examiner—Shanda Hill
(74) *Attorney, Agent, or Firm*—Morgan, Lewis & Bockius LLP

(30) **Foreign Application Priority Data**
Jul. 20, 2007 (KR) 30-2007-0031429

(57) **CLAIM**

(51) **LOC (8) Cl.** **15-07**
(52) **U.S. Cl.** **D15/85**
(58) **Field of Classification Search** D15/79–88,
D15/91; 62/3.1, 3.6, 3.63, 3.64, 45.1, 293,
62/331, 371, 440, 467, 529, 531; 312/236,
312/352, 400–408
See application file for complete search history.

The ornamental design for a refrigerator, as shown and described.

DESCRIPTION

(56) **References Cited**

FIG. 1 is a perspective view of a refrigerator showing my new design;
FIG. 2 is a front view thereof;
FIG. 3 is a rear view thereof;
FIG. 4 is a left side view thereof;
FIG. 5 is a right side view thereof;
FIG. 6 is a top plan view thereof; and,
FIG. 7 is a bottom plan view thereof.

U.S. PATENT DOCUMENTS

D496,373 S * 9/2004 Jang D15/85
D524,832 S * 7/2006 Kim et al. D15/85
D525,993 S * 8/2006 Kim et al. D15/85
D527,395 S * 8/2006 Kim D15/85
D527,745 S * 9/2006 Kim et al. D15/85

1 Claim, 6 Drawing Sheets

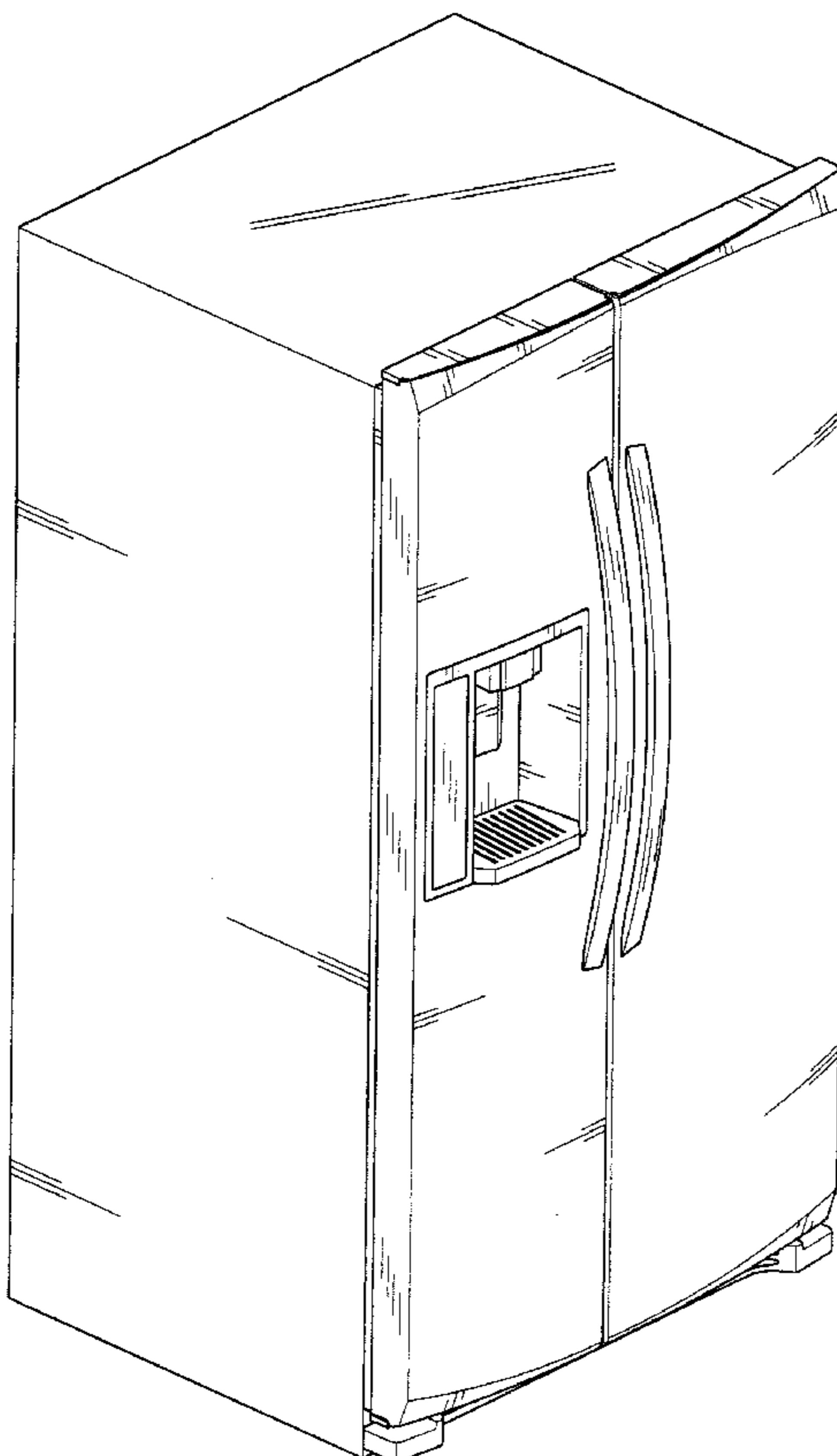

FIG. 1

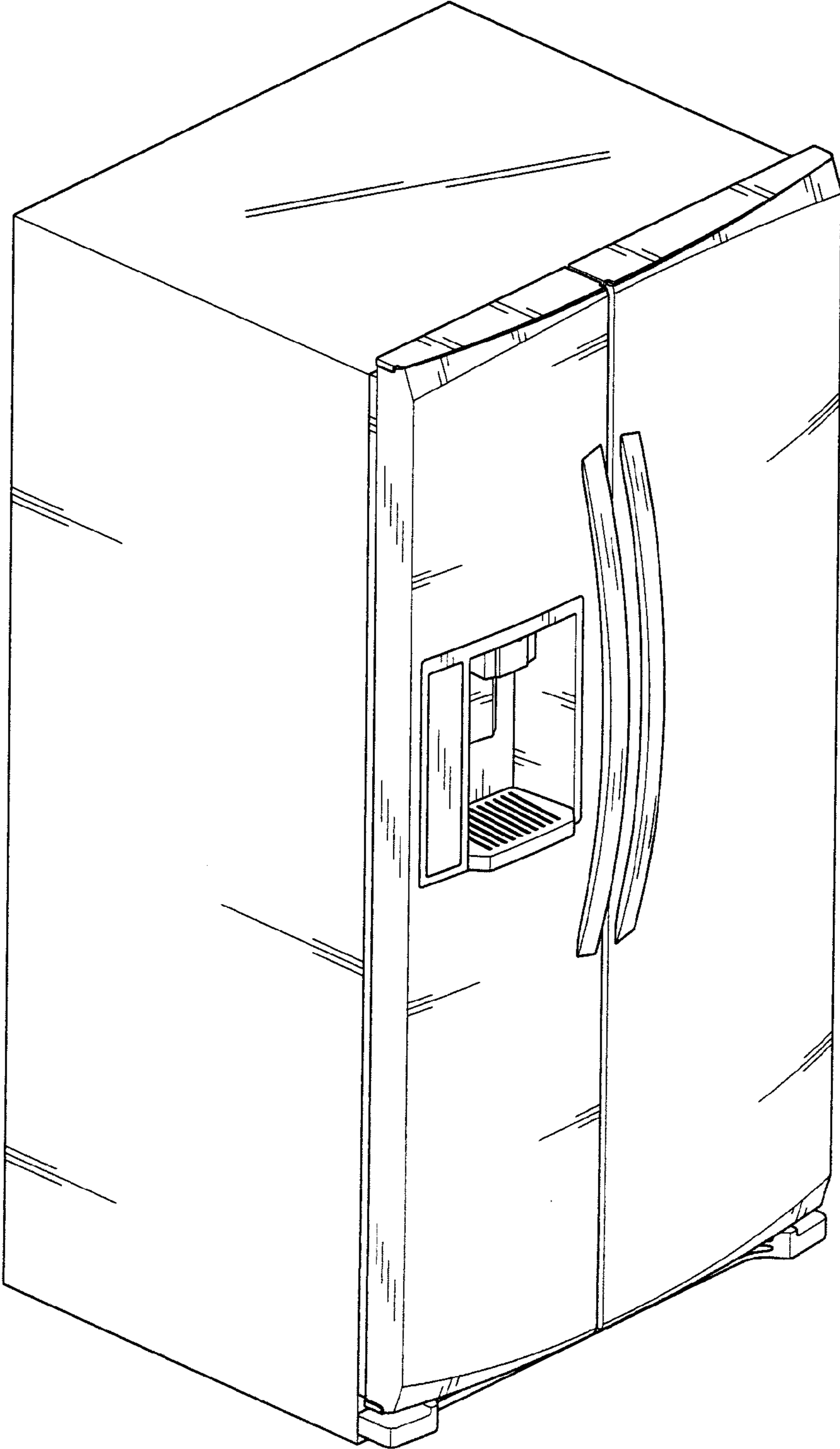

FIG. 2

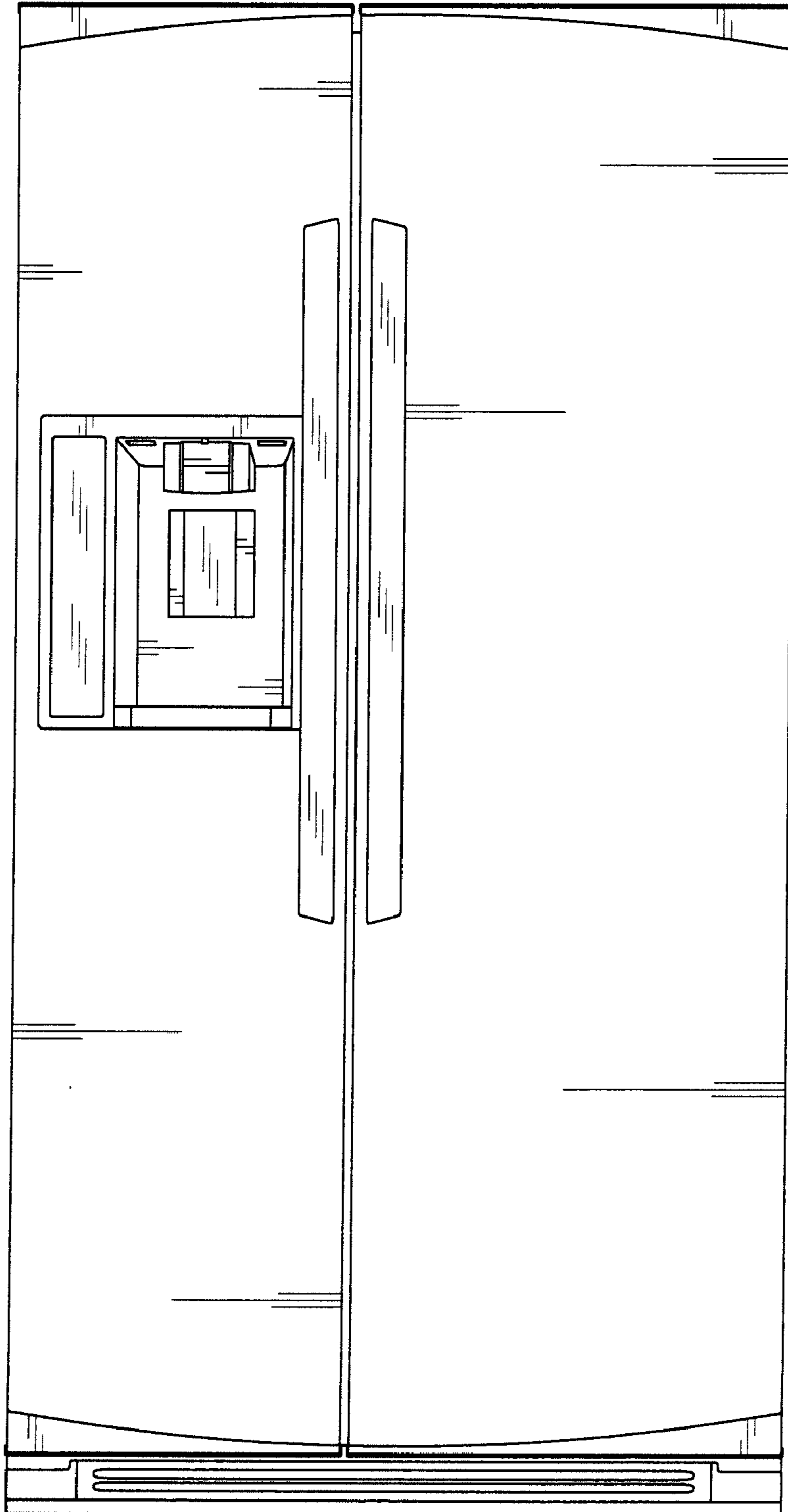

FIG. 3

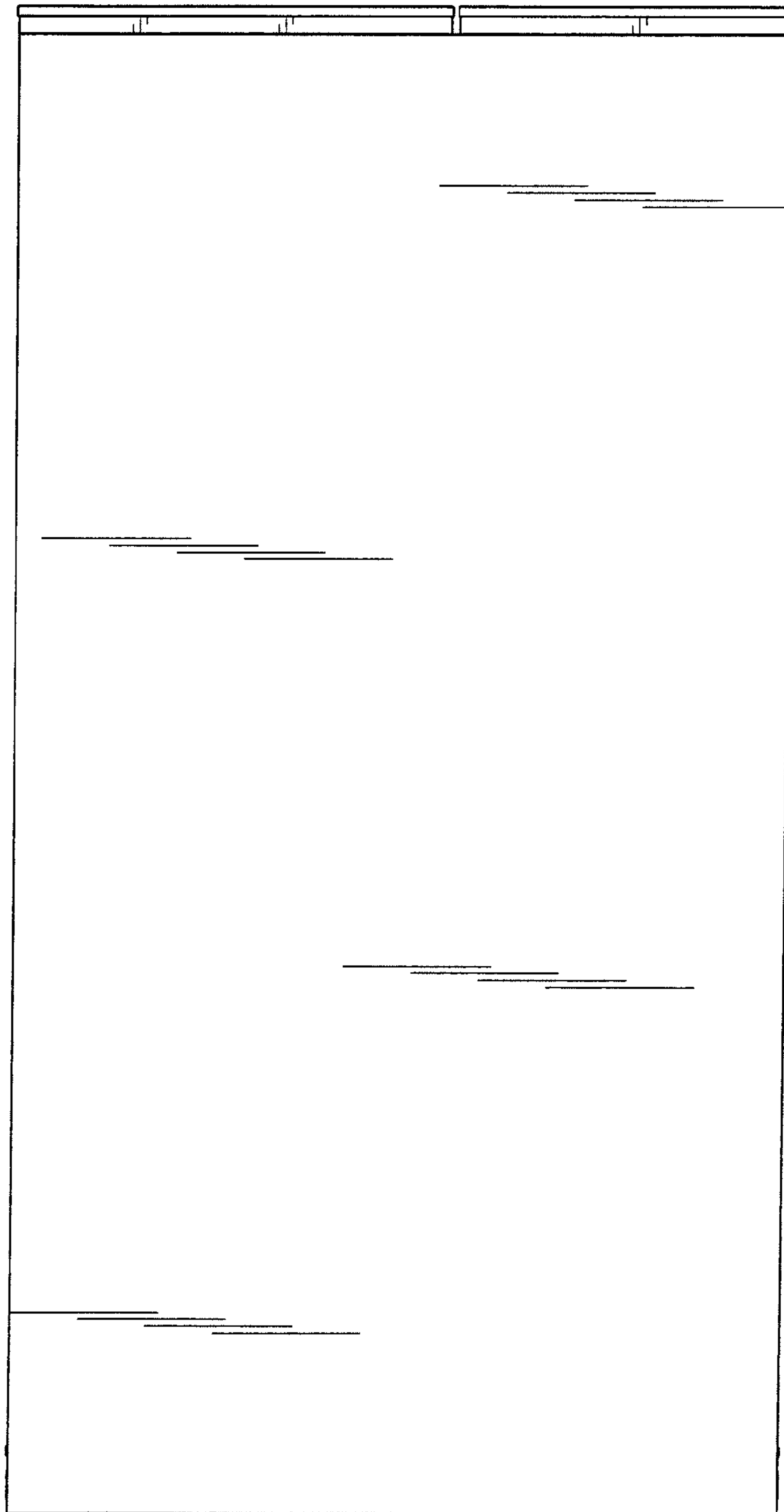

FIG. 4

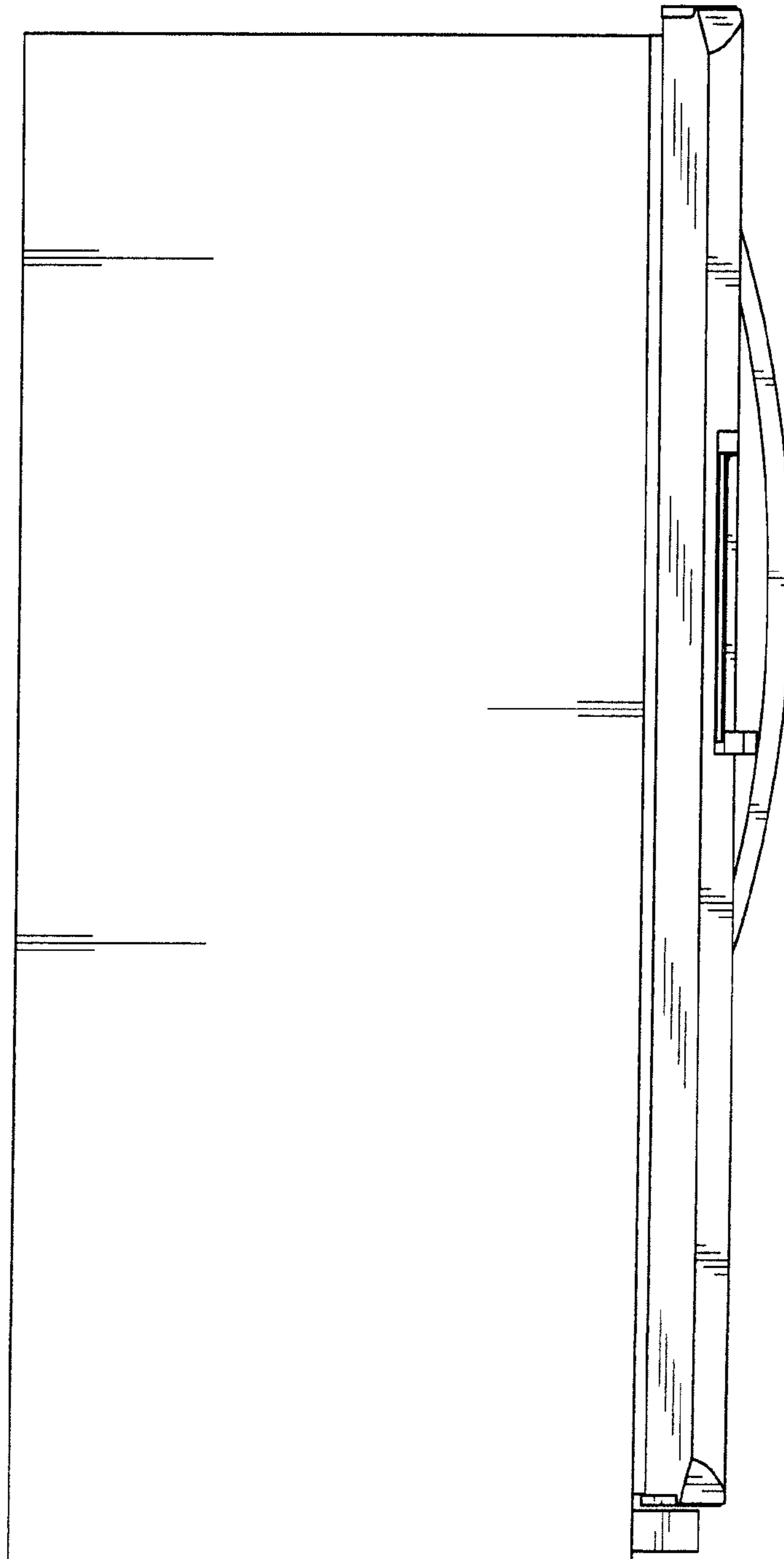

FIG. 5

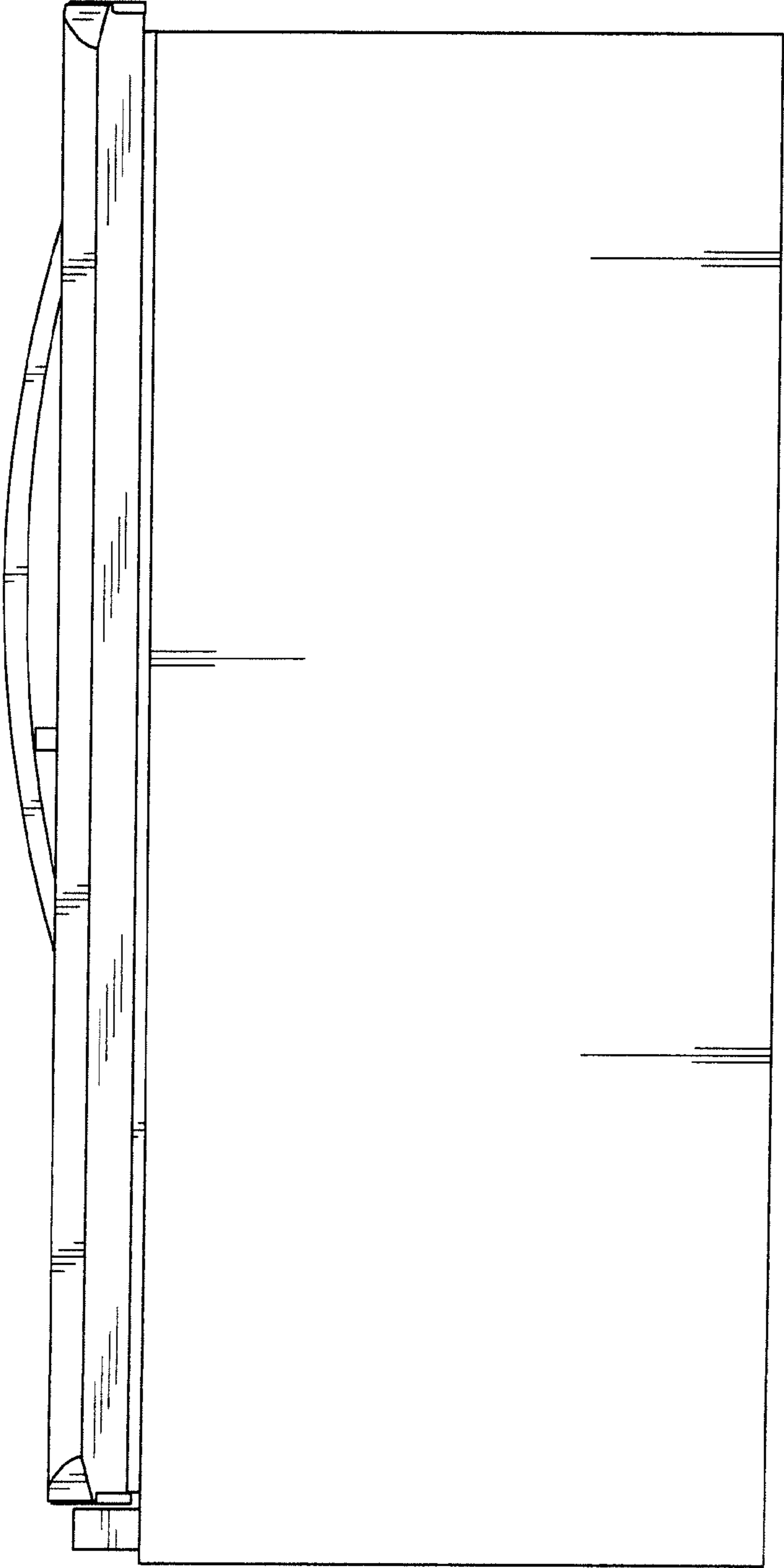

FIG. 6

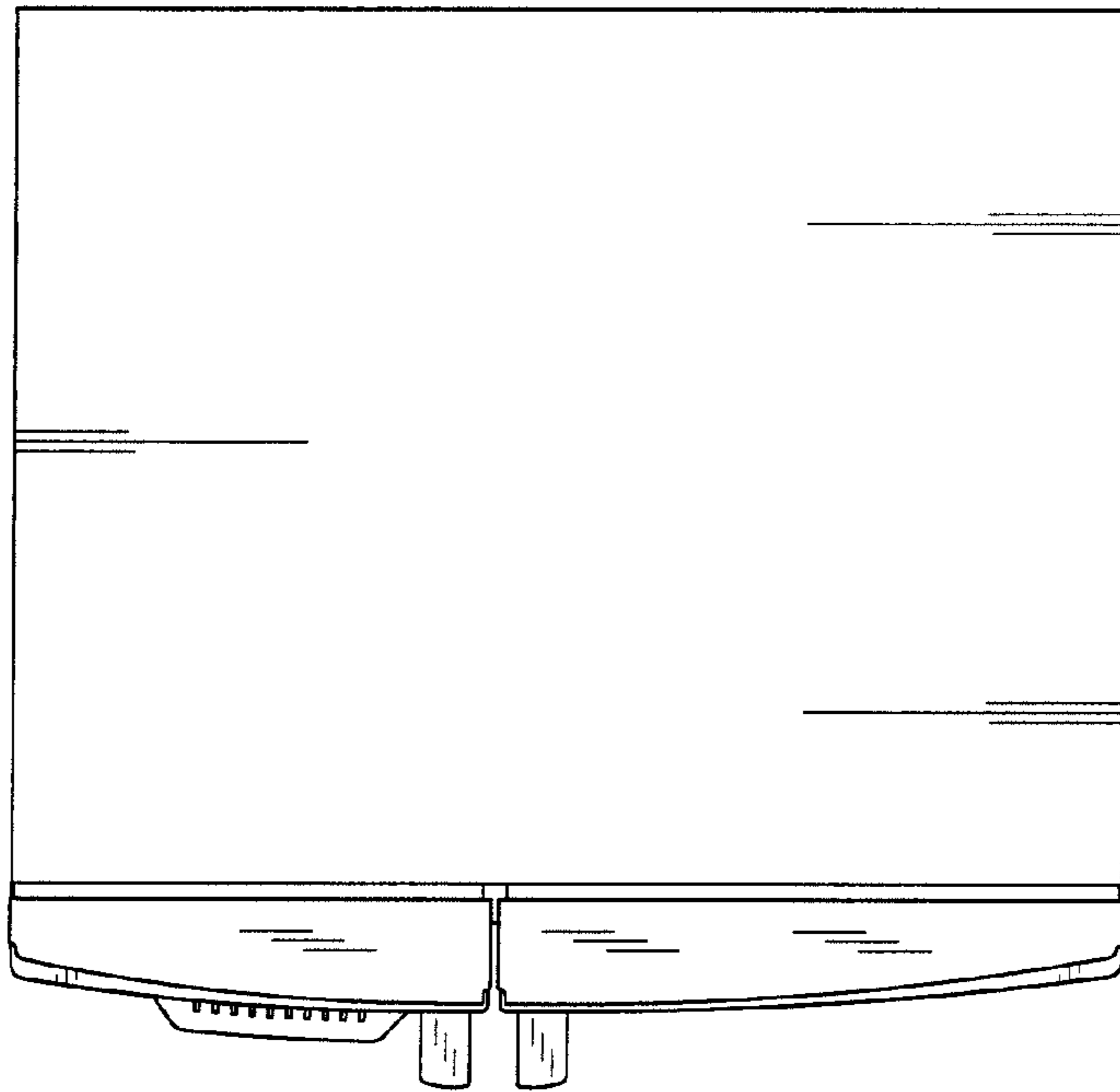

FIG. 7

