



US00D578504S

(12) **United States Design Patent**  
**Stillerman**

(10) **Patent No.:** **US D578,504 S**  
(45) **Date of Patent:** **\*\* Oct. 14, 2008**

(54) **HANDSET**

(75) Inventor: **Jan R. Stillerman**, Thousand Oaks, CA  
(US)

(73) Assignee: **Nokia Corporation**, Espoo (FI)

(\*\*) Term: **14 Years**

(21) Appl. No.: **29/298,582**

(22) Filed: **Dec. 7, 2007**

(51) **LOC (8) Cl.** ..... **14-03**

(52) **U.S. Cl.** ..... **D14/138**

(58) **Field of Classification Search** ..... D14/138,  
D14/496, 341-347; 455/575.3, 575.1  
See application file for complete search history.

(56) **References Cited**

U.S. PATENT DOCUMENTS

D487,453 S	3/2004	Ribeiro et al.	
D500,750 S	1/2005	Arnholt et al.	
D507,277 S *	7/2005	Sitoh	D14/496
D513,742 S	1/2006	Arnholt et al.	
D521,970 S *	5/2006	Han et al.	D14/138
D525,224 S *	7/2006	Pitt et al.	D14/138
D537,059 S *	2/2007	Hwang	D14/138
D540,769 S *	4/2007	Lee et al.	D14/138
D543,172 S *	5/2007	Lee et al.	D14/138
D543,173 S *	5/2007	Park et al.	D14/138
D545,796 S *	7/2007	Kim et al.	D14/138
D549,199 S *	8/2007	Sugiura	D14/138
D551,642 S *	9/2007	Kim et al.	D14/138
D552,576 S *	10/2007	Kim et al.	D14/138
D553,110 S *	10/2007	Park et al.	D14/138
D554,093 S *	10/2007	Arnholt et al.	D14/138
D554,094 S *	10/2007	Ribeiro et al.	D14/138
D554,113 S	10/2007	Arnholt et al.	
7,286,861 B2 *	10/2007	Woo	455/575.3
D554,633 S	11/2007	Park et al.	
D558,167 S *	12/2007	Jung et al.	D14/138
D560,643 S *	1/2008	Kim et al.	D14/138
D563,358 S *	3/2008	Baik et al.	D14/138
D563,376 S *	3/2008	Arnholt et al.	D14/138
D565,010 S *	3/2008	Baik et al.	D14/138

D566,670 S *	4/2008	Huang	D14/138
D567,209 S *	4/2008	Moss et al.	D14/138
D567,784 S *	4/2008	Lee et al.	D14/138
D571,337 S *	6/2008	Lee et al.	D14/138
D571,773 S *	6/2008	Kim et al.	D14/138
D572,690 S *	7/2008	Kim et al.	D14/138

OTHER PUBLICATIONS

Nokia 6650T-Mobile telephone, announced Mar. 2008, [online], [site visited Jul. 7, 2008]. Available from Internet ,<URL: <http://www.gsmarena.com>>.\*

(Continued)

*Primary Examiner*—Jeffrey D Asch

(74) *Attorney, Agent, or Firm*—Banner & Witcoff, Ltd

(57) **CLAIM**

The ornamental design for a handset, as shown and described.

**DESCRIPTION**

FIG. 1 is a perspective front view of a handset showing my new design;

FIG. 2 is a front view thereof;

FIG. 3 is a rear view thereof;

FIG. 4 is a left side view thereof;

FIG. 5 is a right side view thereof;

FIG. 6 is a top view thereof;

FIG. 7 is a bottom view thereof;

FIG. 8 is a perspective front view of the handset of FIGS. 1-7 in an in-use open position;

FIG. 9 is a perspective rear view thereof;

FIG. 10 is a front view thereof;

FIG. 11 is a rear view thereof;

FIG. 12 is a left side view thereof;

FIG. 13 is a right side view thereof;

FIG. 14 is a top view thereof; and,

FIG. 15 is a bottom view thereof.

**1 Claim, 8 Drawing Sheets**

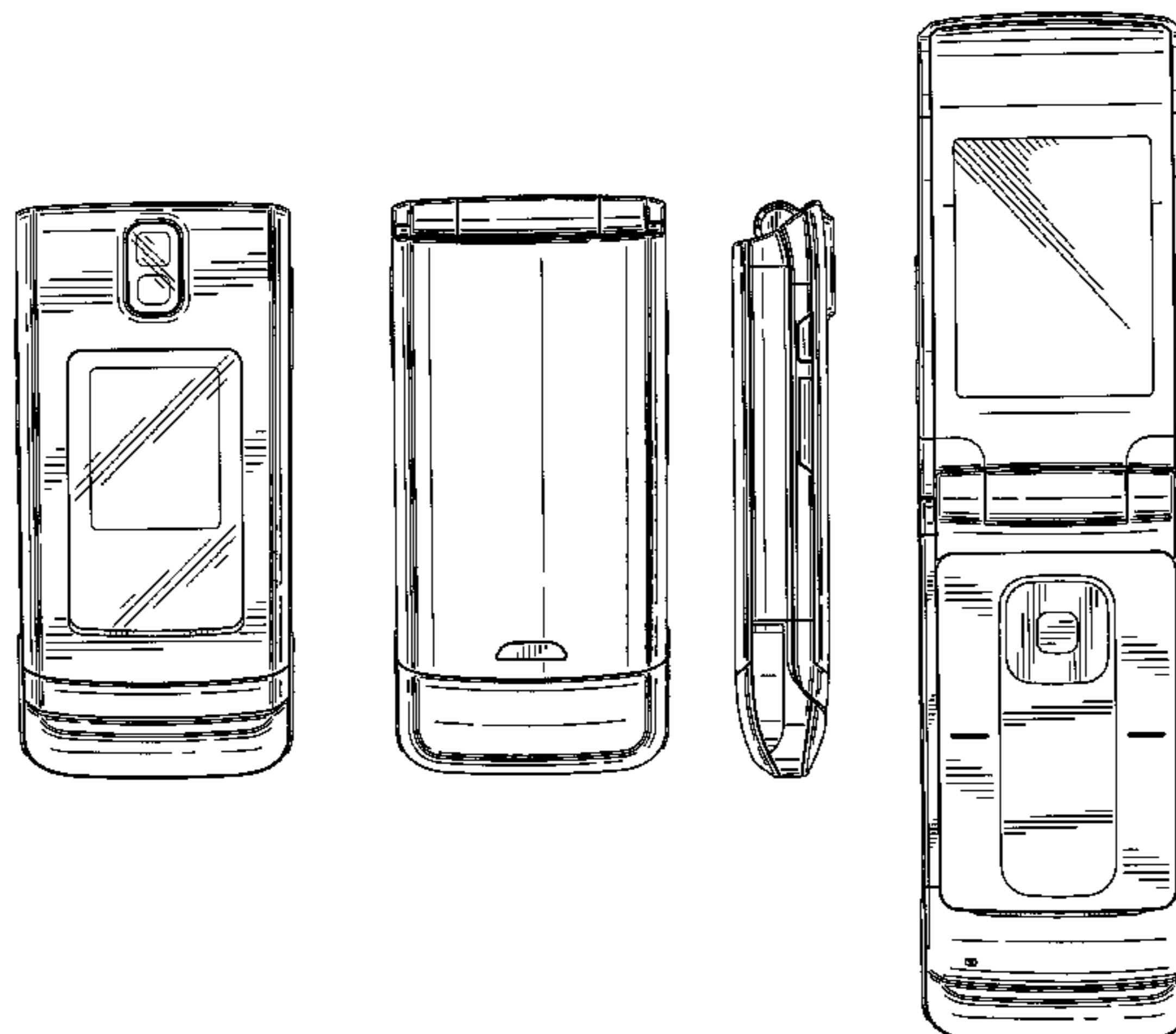

OTHER PUBLICATIONS

Motorola KRZR K3 telephone, announced Feb. 2007, [online], [site visited Jul. 7, 2008]. Available from Internet ,<URL: <http://www.gsmarena.com>>.\*

LG Trax CU575 telephone, announced Aug. 2007, [online], [site visited Jul. 7, 2008]. Available from Internet ,<URL: <http://www.gsmarena.com>>.\*

LG U830 telephone, announced Oct. 2006, [online], [site visited Jul. 7, 2008]. Available from Internet ,<URL: <http://www.gsmarena.com>>.\*

Sagem myMobileTV 2 telephone, announced Feb. 2006, [online], [site visited Jul. 7, 2008]. Available from Internet ,<URL: <http://www.gsmarena.com>>.\*

Philips 760 telephone, announced 1<sup>st</sup> quarter-2005, [online], [site visited Jul. 7, 2008]. Available from Internet ,<URL: <http://www.gsmarena.com>>.\*

Internet printout: <http://www.mydigitallife.info/wp-content/uploads/2007/05/motorola-razr-2.jpg> dated Nov. 16, 2007.

Internet printout: <http://www.welectronics.com/gsm/Motorola/motorola%20razr%20v3.jpg> dated Nov. 16, 2007.

\* cited by examiner

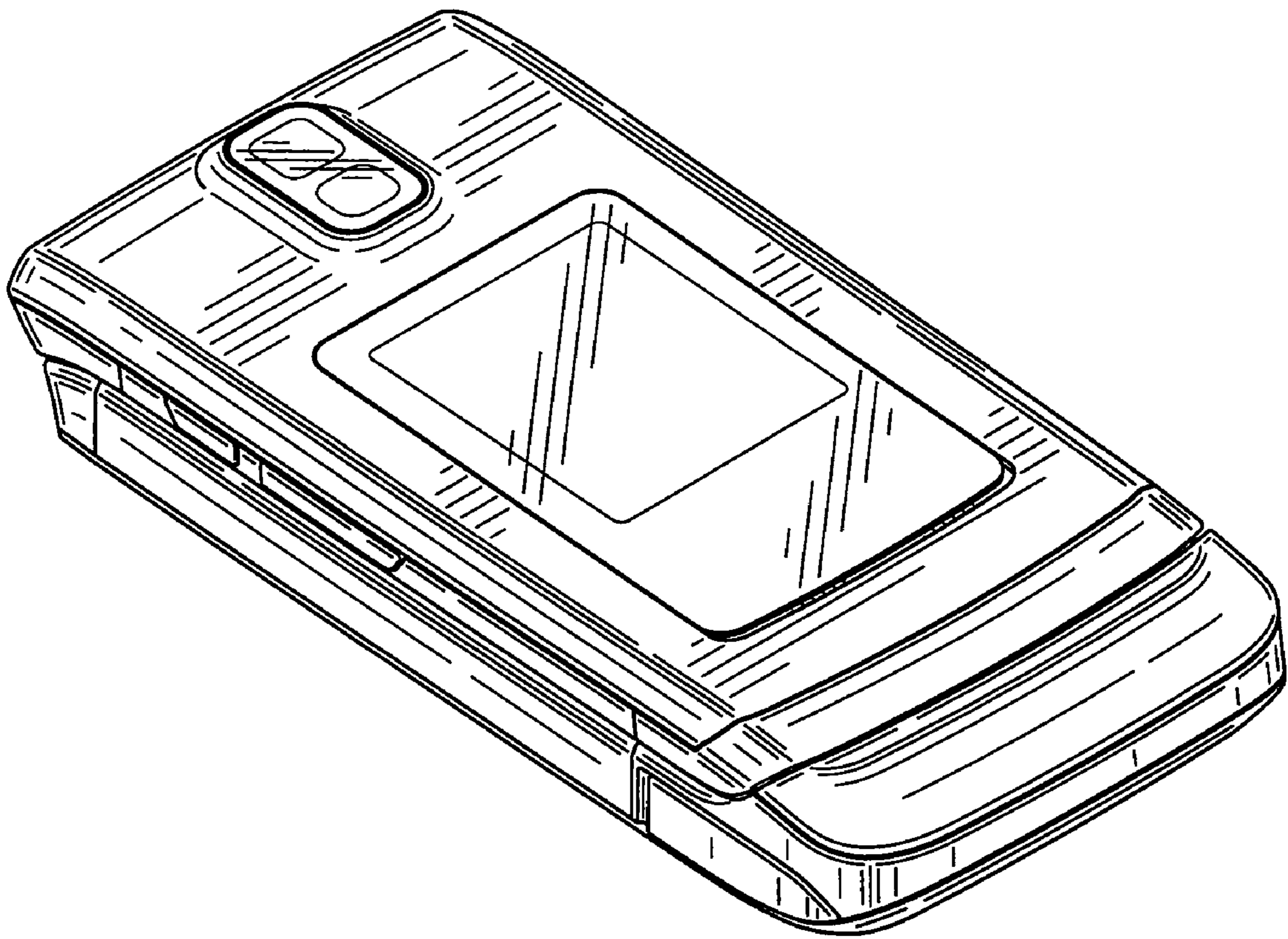

FIG. 1

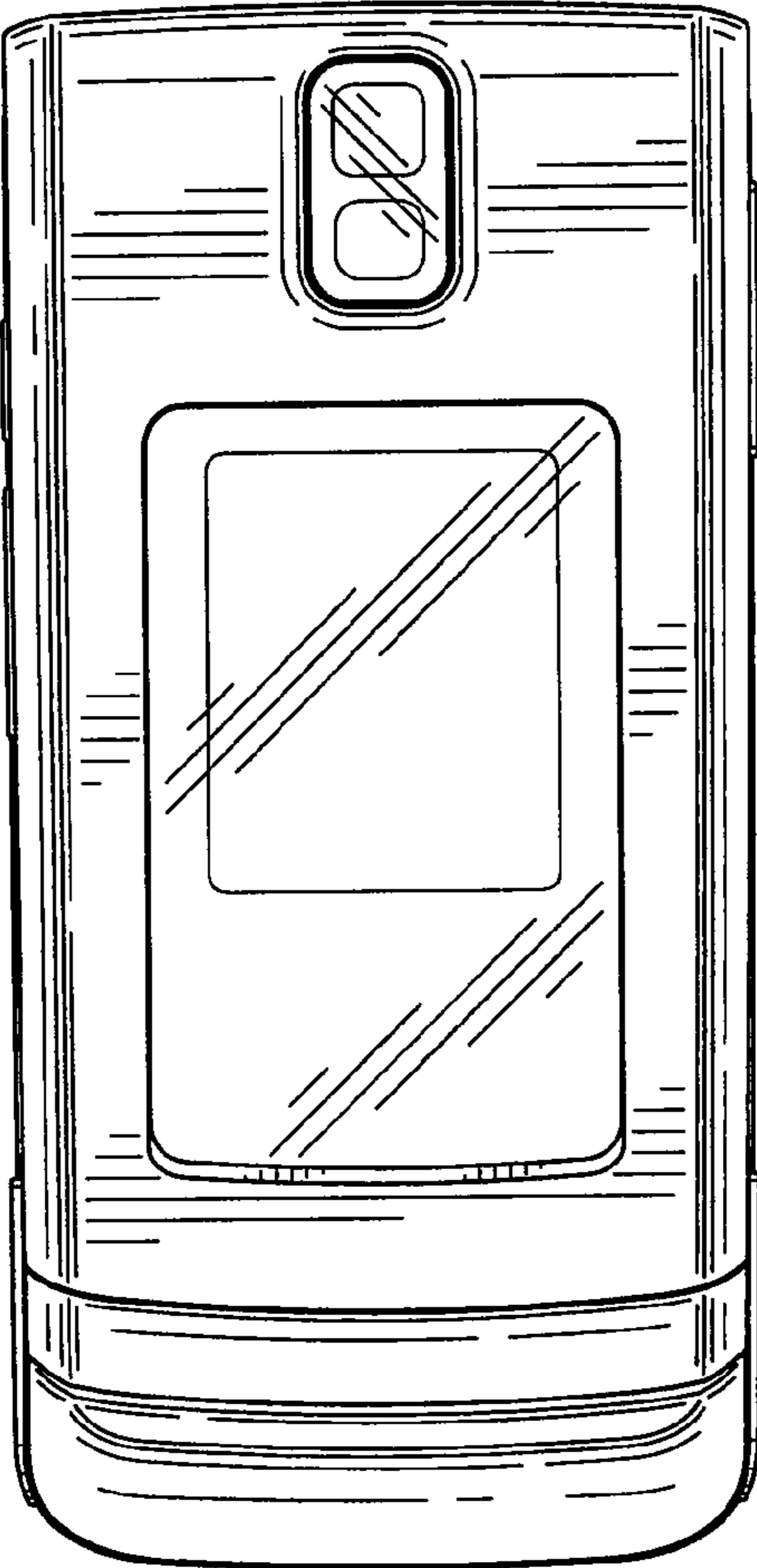

FIG. 2

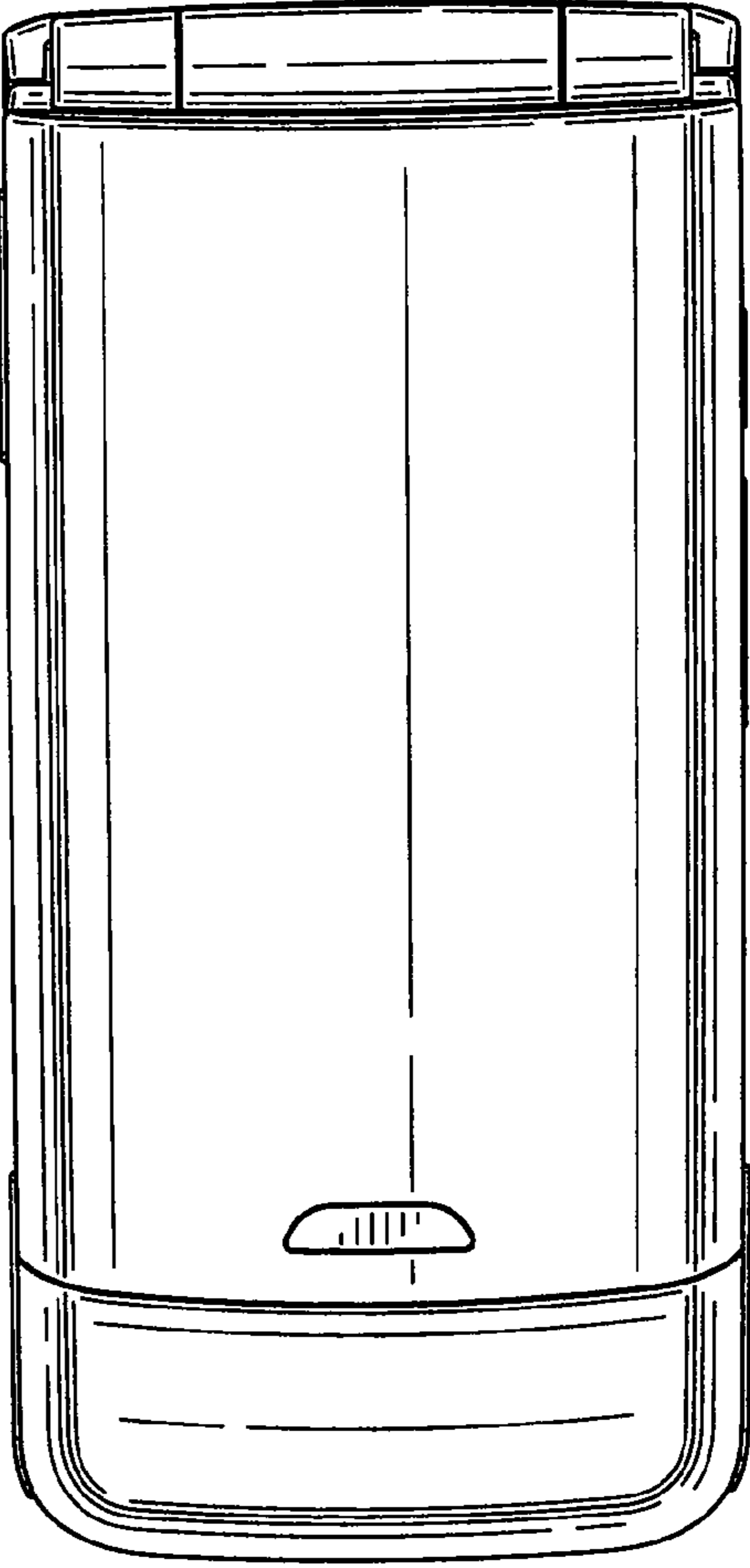

FIG. 3

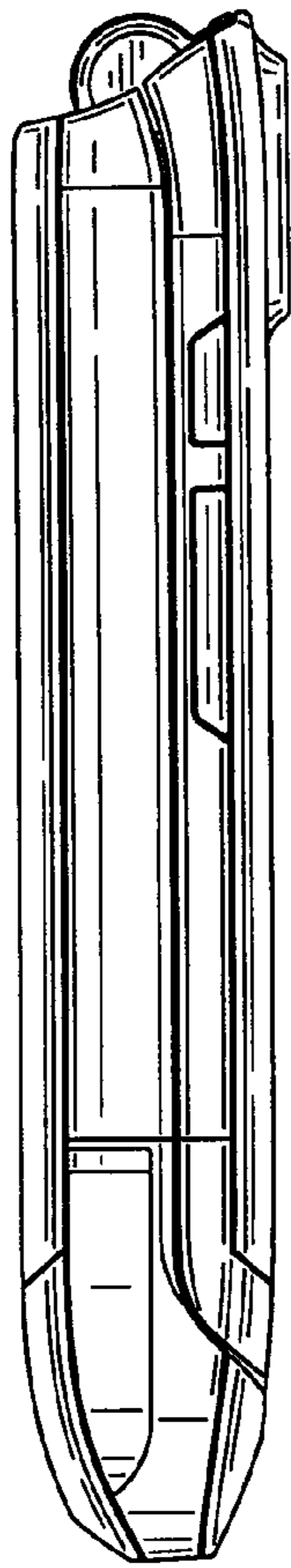

FIG. 4

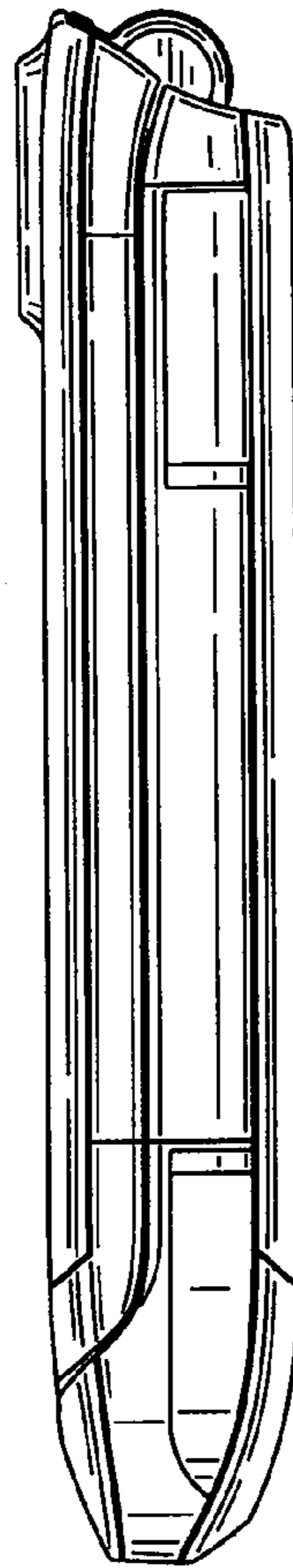

FIG. 5



FIG. 6

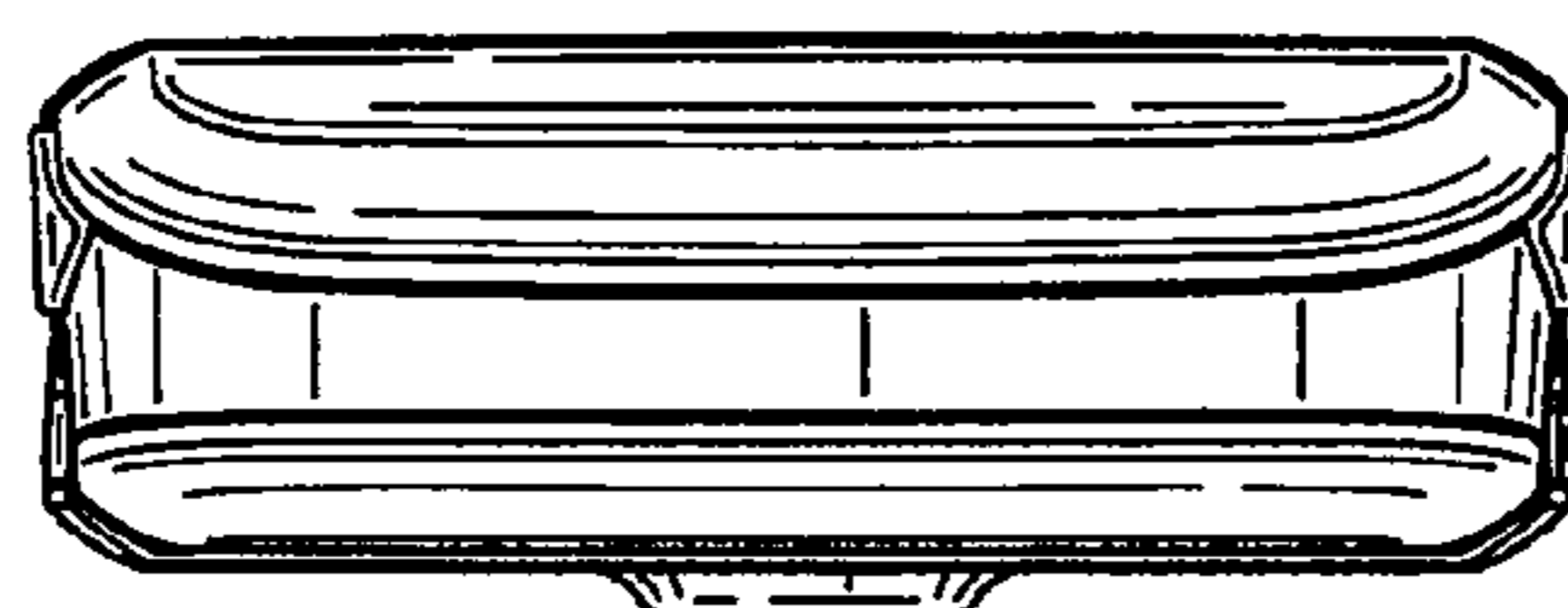

FIG. 7

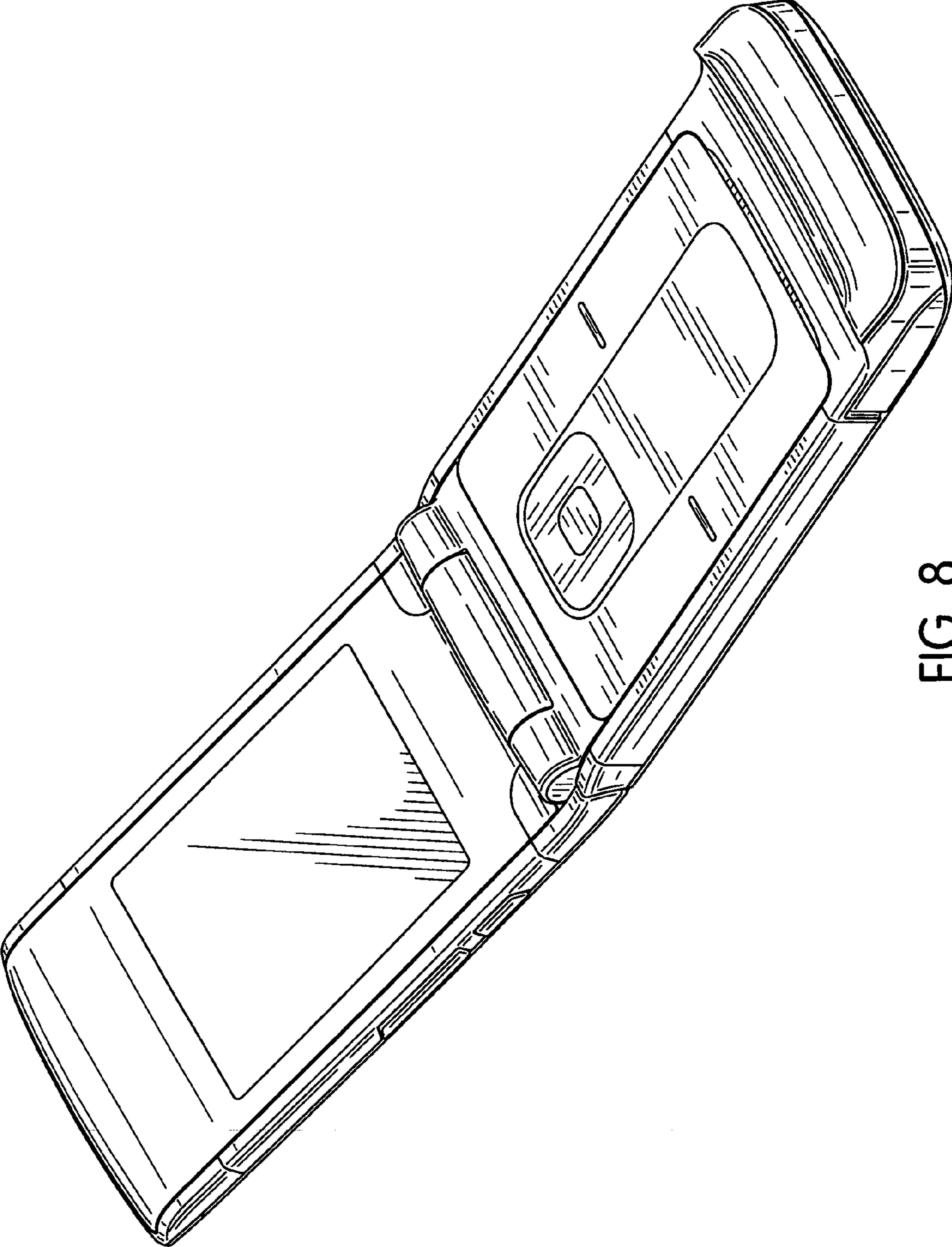

FIG. 8

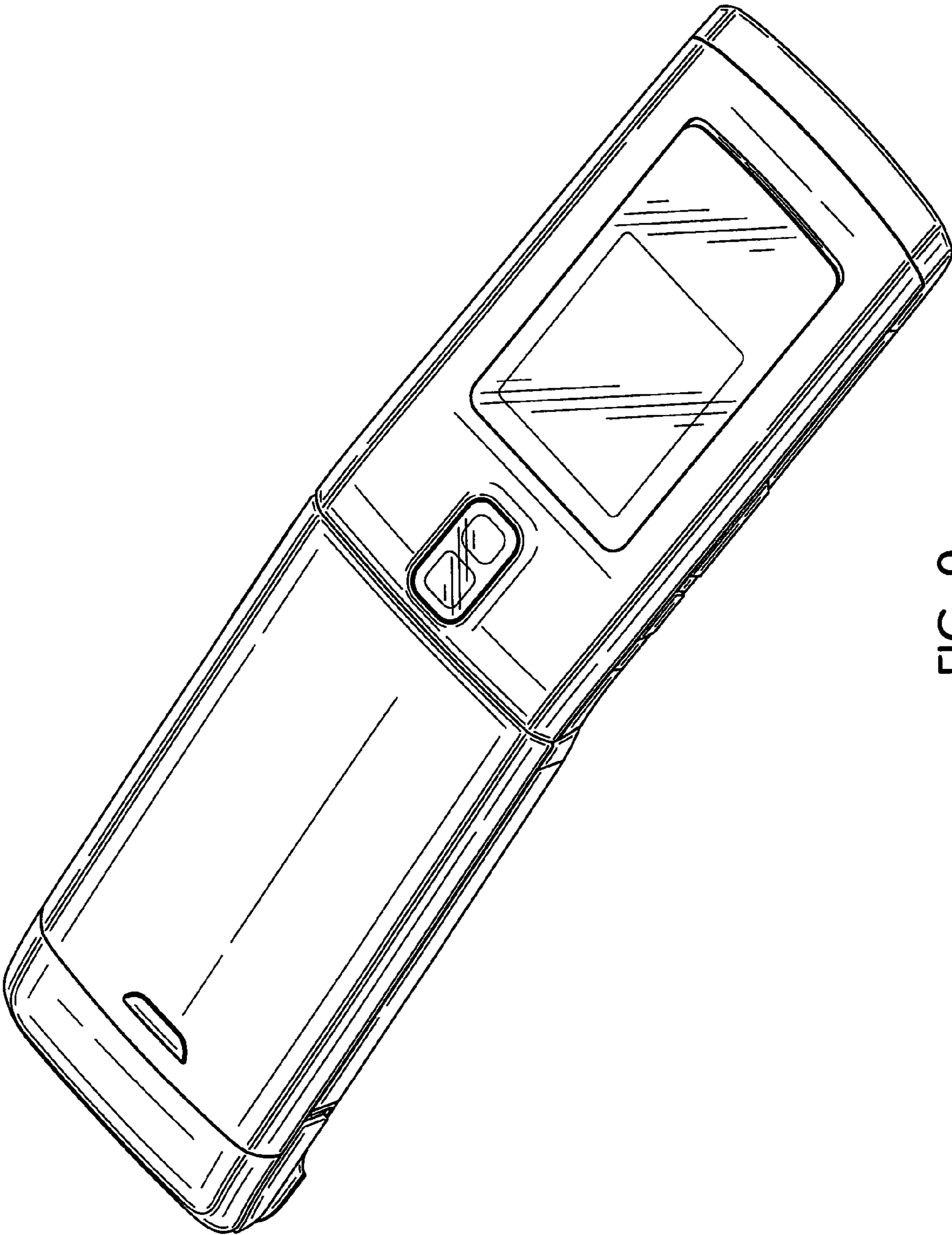

FIG. 9

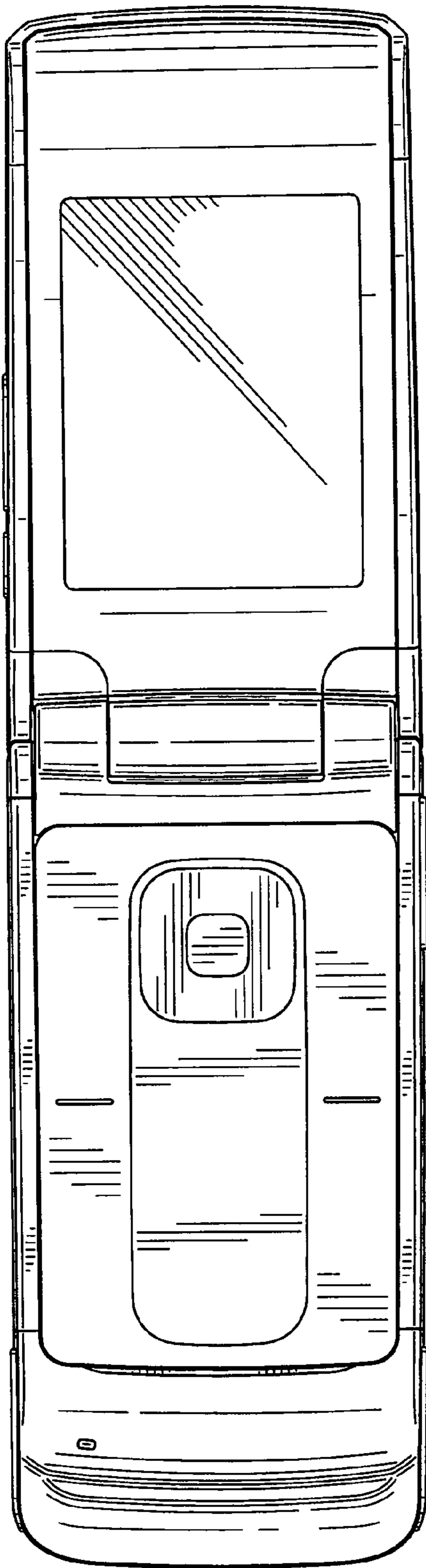

FIG. 10

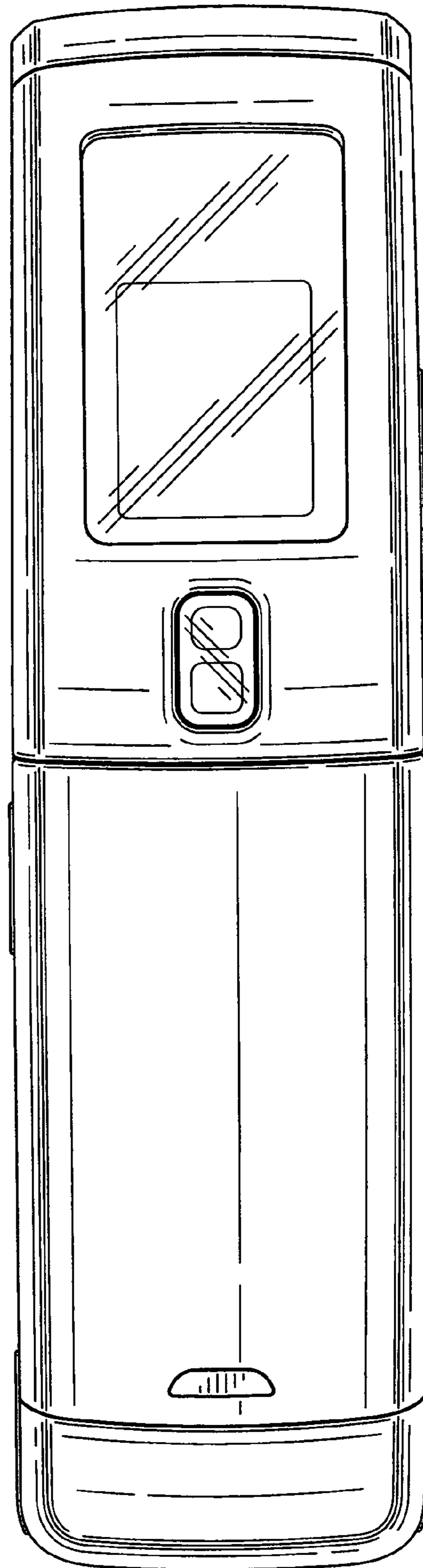

FIG. 11



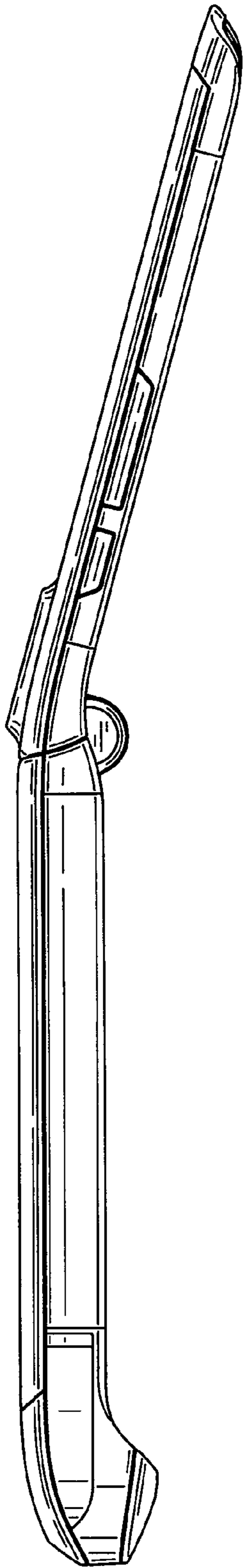

FIG. 12

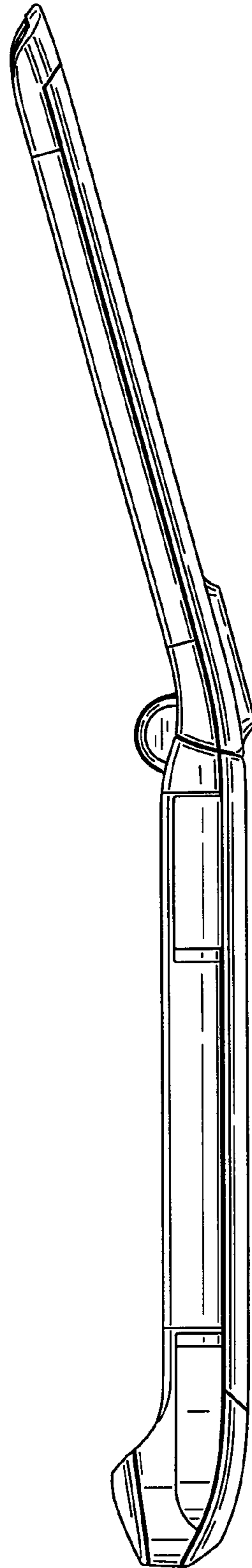

FIG. 13

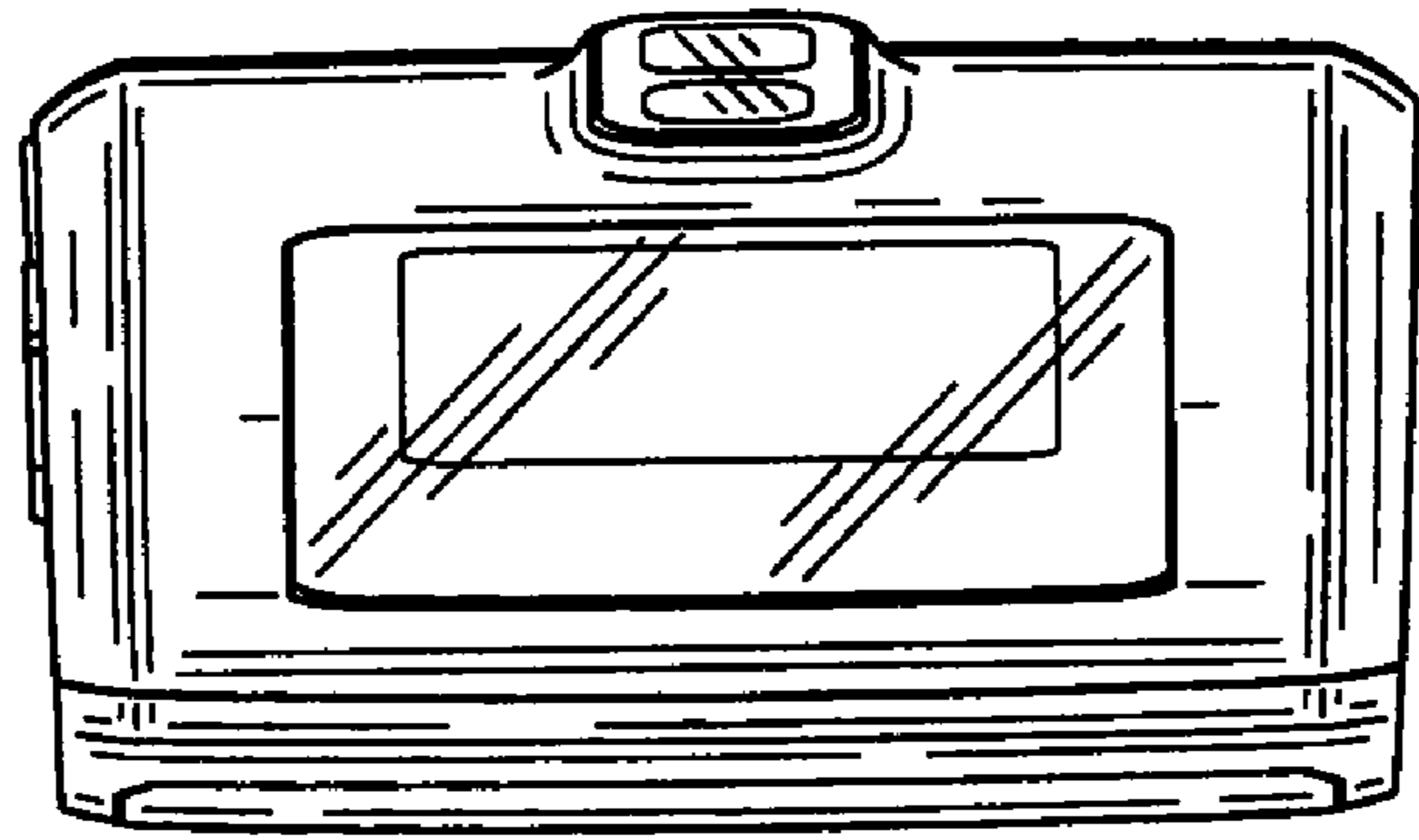

FIG. 14

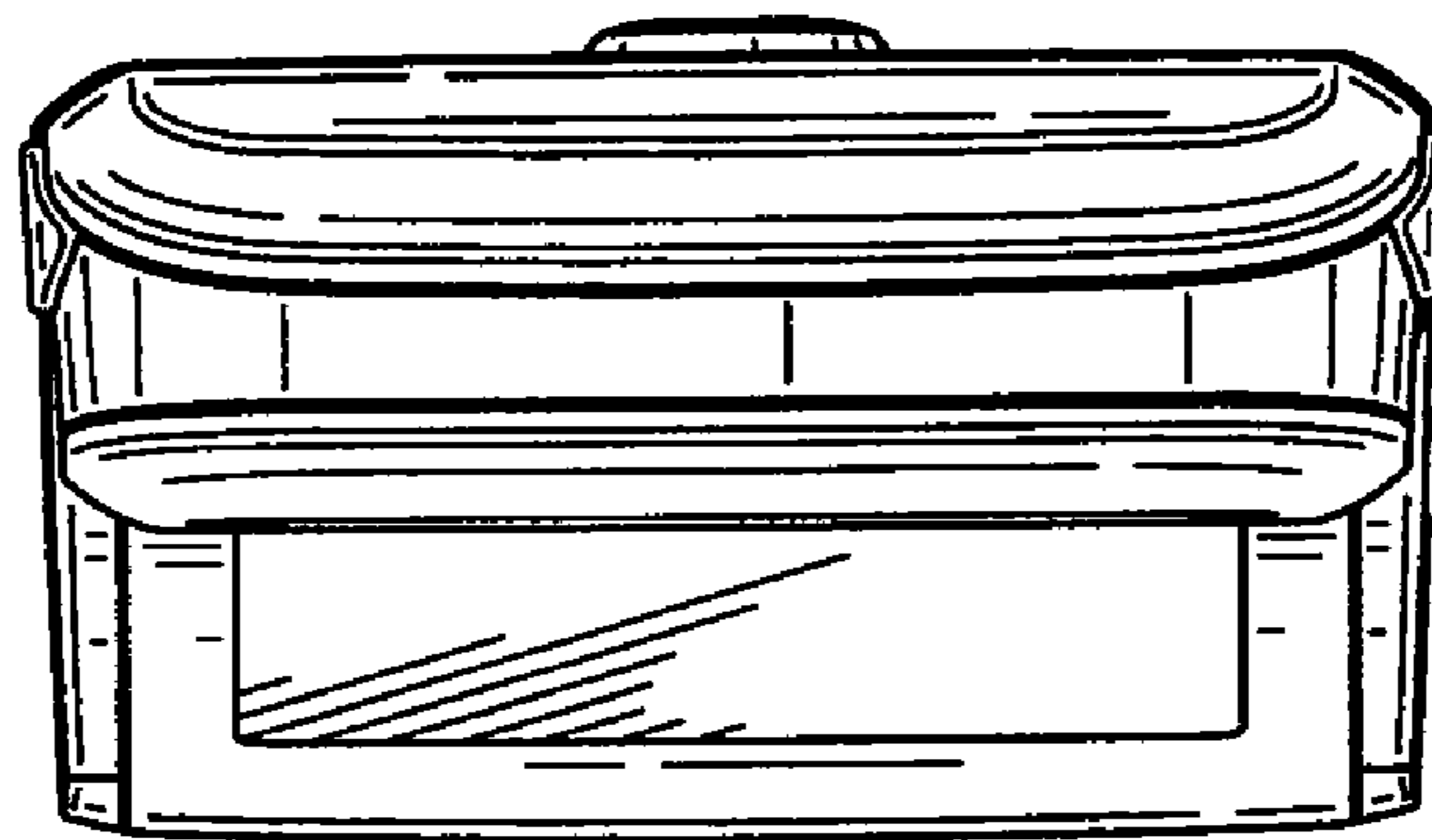

FIG. 15