



US00D578465S

(12) **United States Design Patent**
Kosaka

(10) **Patent No.:** **US D578,465 S**

(45) **Date of Patent:** **** Oct. 14, 2008**

(54) **PORTION OF AN AUTOMOBILE**

(75) Inventor: **Shiro Kosaka**, Tokyo (JP)

(73) Assignee: **Gallery Abarth Inc.**, Tokyo (JP)

(**) Term: **14 Years**

(21) Appl. No.: **29/283,527**

(22) Filed: **Aug. 16, 2007**

(30) **Foreign Application Priority Data**

Feb. 16, 2007 (JP) 2007-003725

(51) **LOC (8) Cl.** **12-16**

(52) **U.S. Cl.** **D12/401**

(58) **Field of Classification Search** D12/400,
D12/401, 404; 296/37.8, 176, 171, 172,
296/185, 200, 219; 188/5; 280/523

See application file for complete search history.

(56) **References Cited**

U.S. PATENT DOCUMENTS

2,861,836	A *	11/1958	Goeggel	296/219
D413,096	S *	8/1999	Russke et al.	D12/404
D450,031	S *	11/2001	Hall	D12/401
D488,121	S *	4/2004	Dowdey	D12/404
D488,767	S *	4/2004	Ebert et al.	D12/401
D514,055	S *	1/2006	Hemenway	D12/401
2007/0114818	A1 *	5/2007	Reitzloff et al.	296/219

* cited by examiner

Primary Examiner—Robert M. Spear
Assistant Examiner—George D Kirschbaum
(74) *Attorney, Agent, or Firm*—Banner and Witcoff, Ltd.

(57) **CLAIM**

The ornamental design for a portion of an automobile, as shown and described.

DESCRIPTION

FIG. 1 is a front, top and right side perspective view of a portion of an automobile, showing my new design;

FIG. 2 is a front elevational view thereof;

FIG. 3 is a rear elevational view thereof;

FIG. 4 is a top plan view thereof;

FIG. 5 is a bottom plan view thereof;

FIG. 6 is a right side elevational view thereof;

FIG. 7 is a left side elevational view thereof;

FIG. 8 is a top plan view thereof with a canvas top in an opened state;

FIG. 9 is a front elevational view thereof with the canvas top in an opened state;

FIG. 10 is a top plan view thereof showing an example of state of use; and,

FIG. 11 is a front elevational view thereof showing an example of state of use.

The broken lines depict unclaimed environmental subject matter.

1 Claim, 10 Drawing Sheets

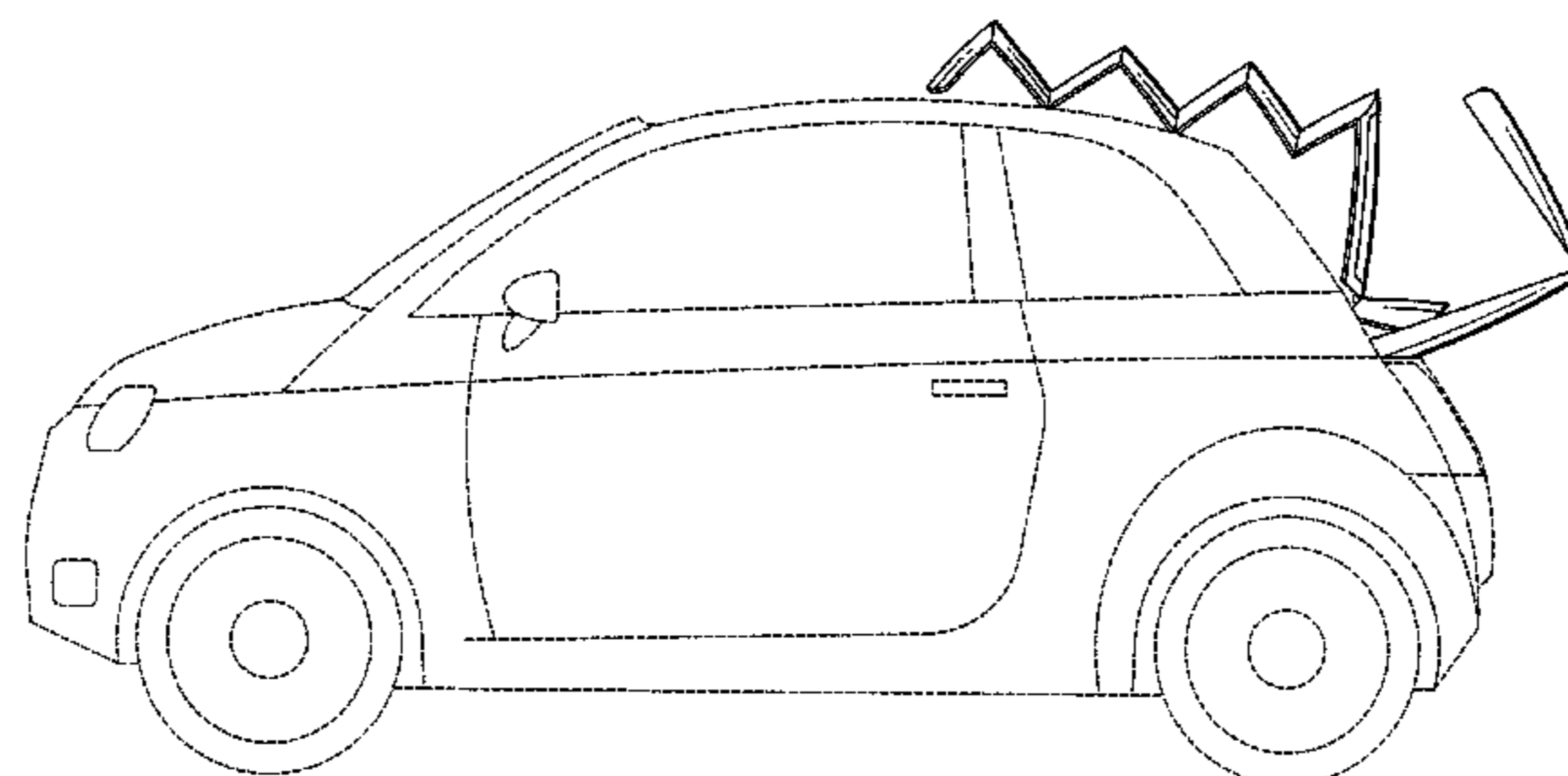
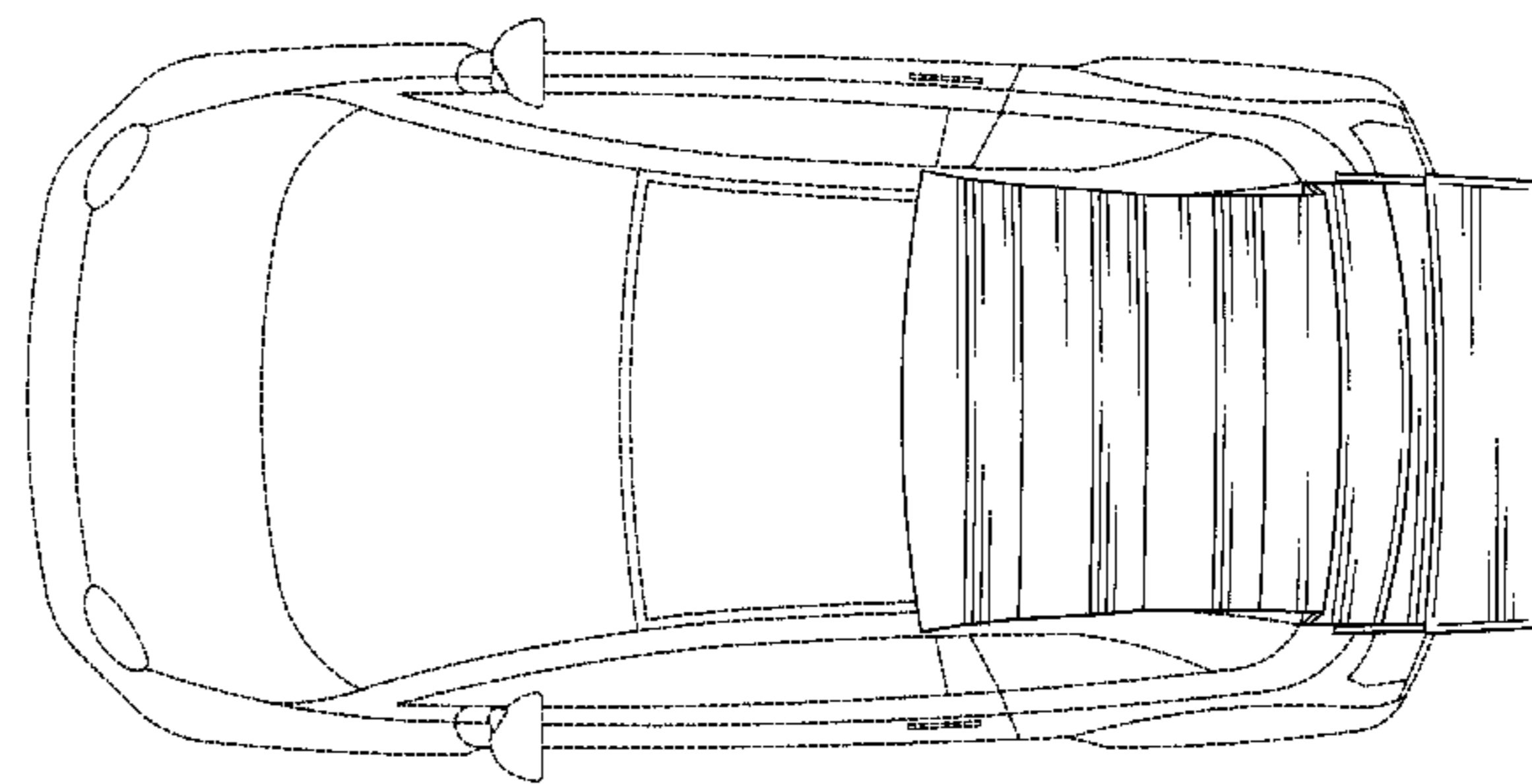
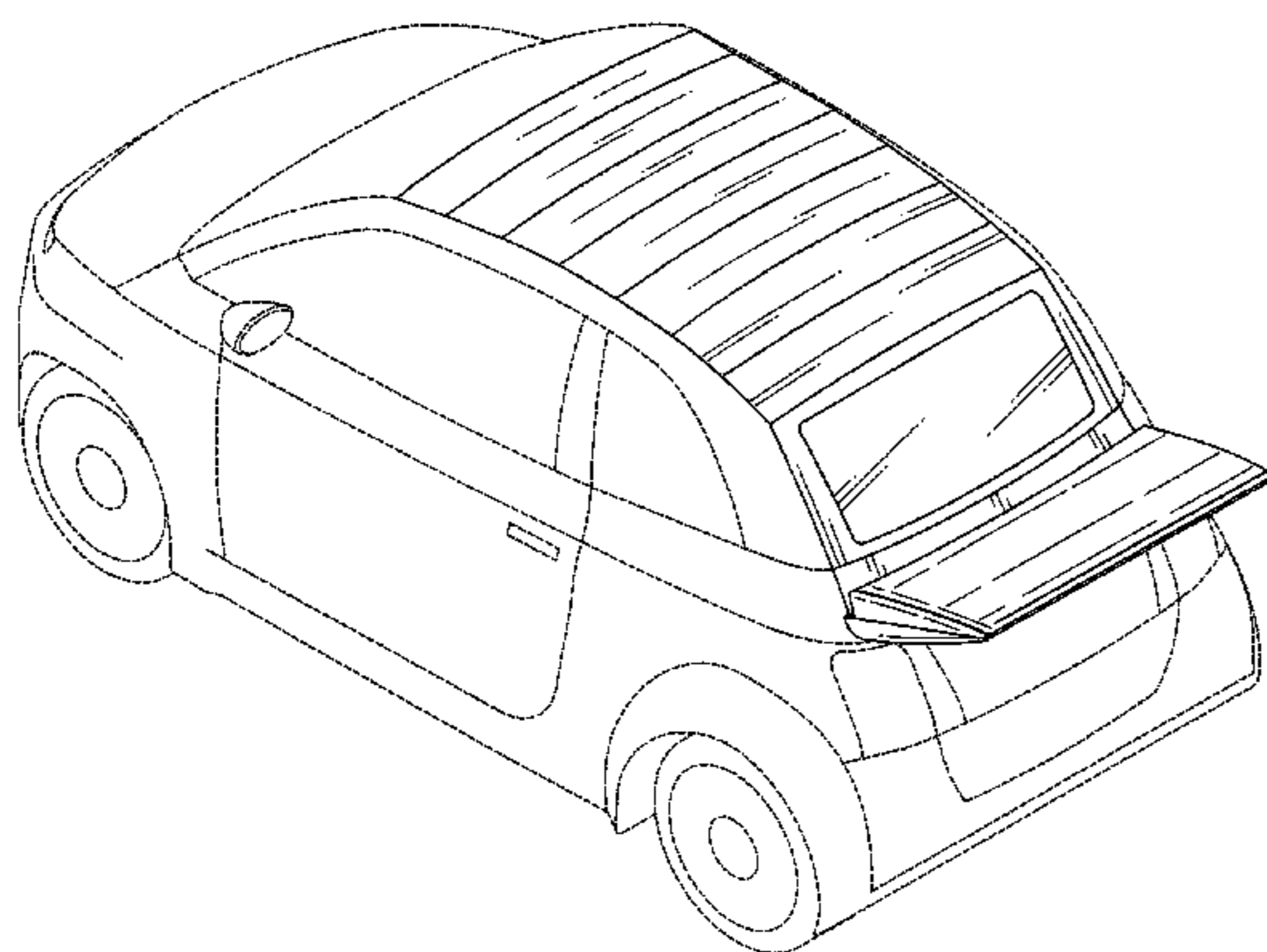

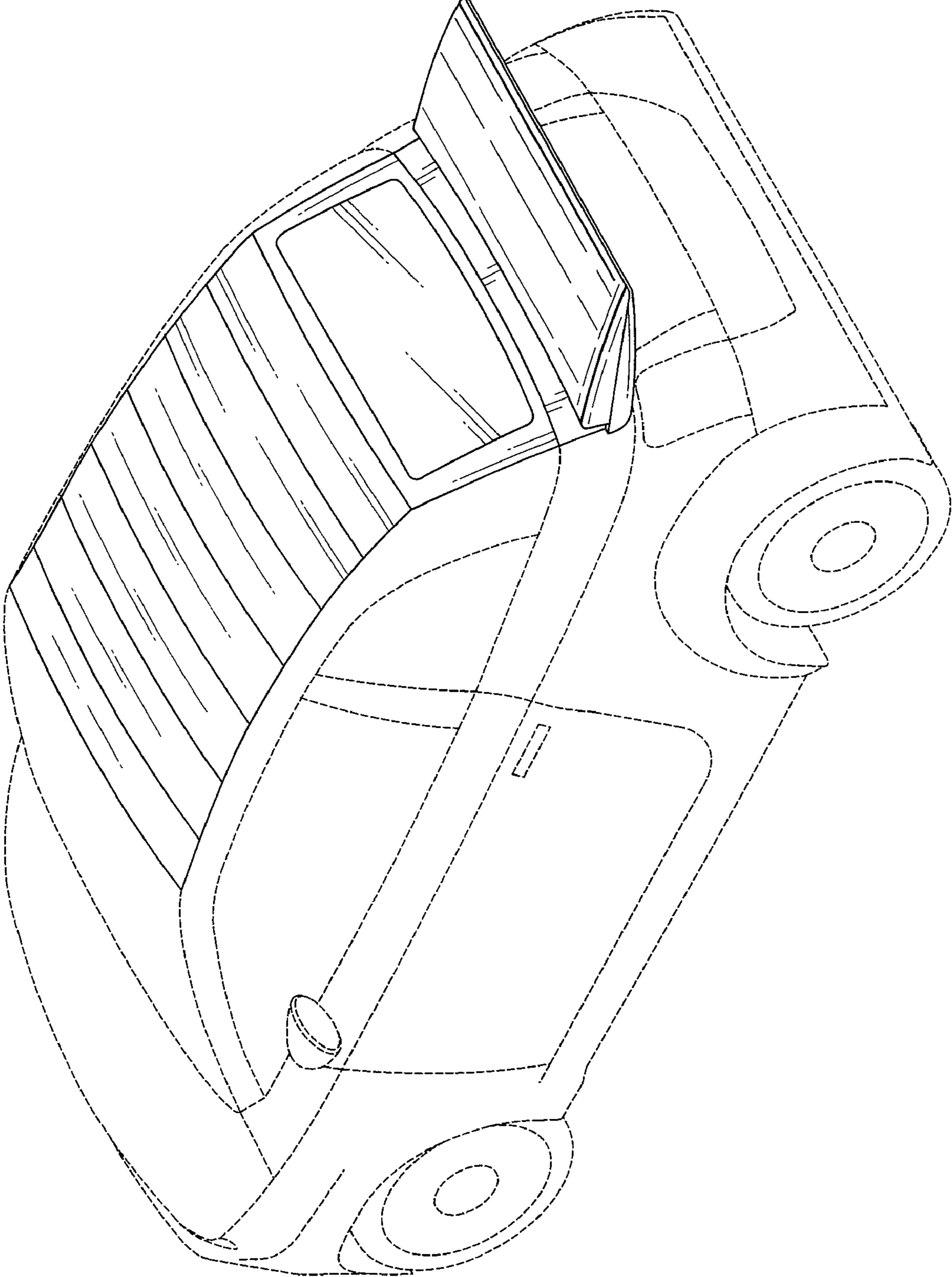

FIG.1

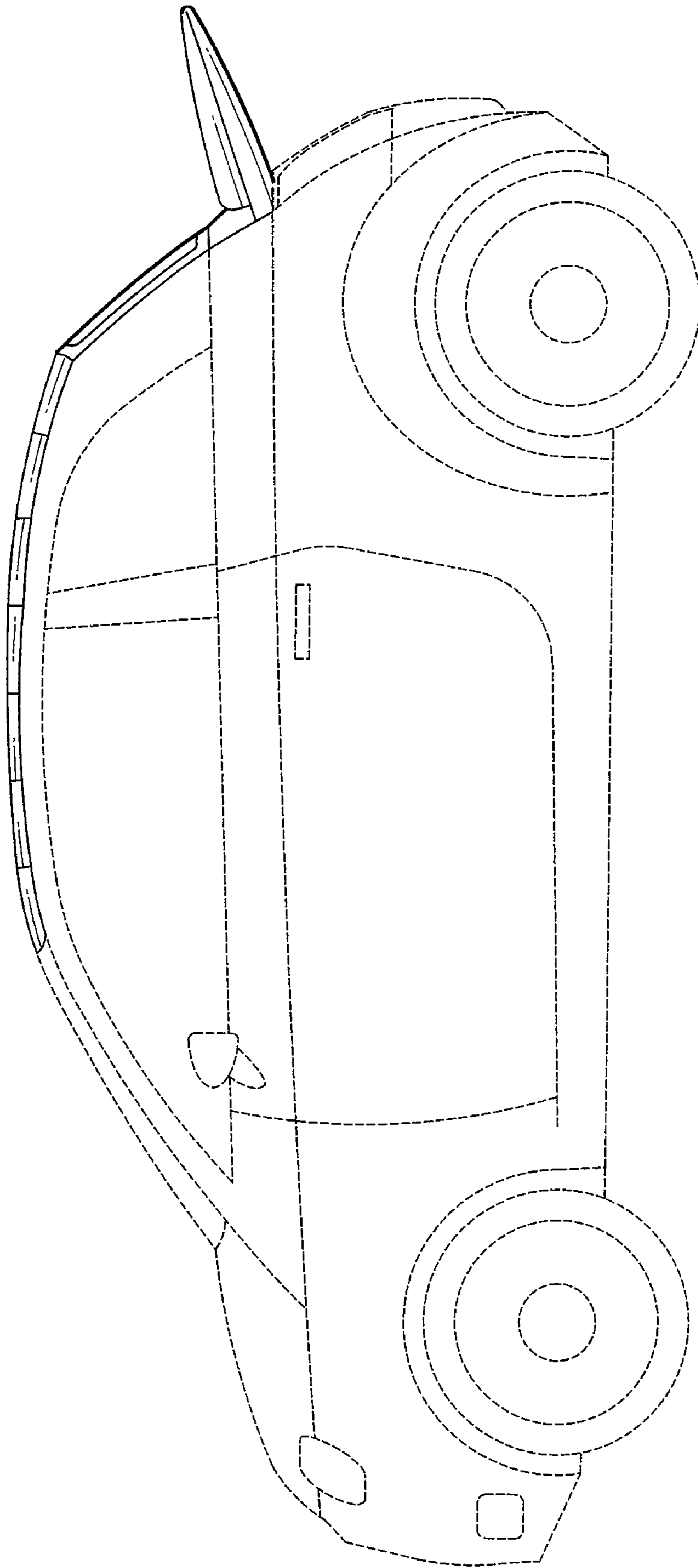

FIG.2

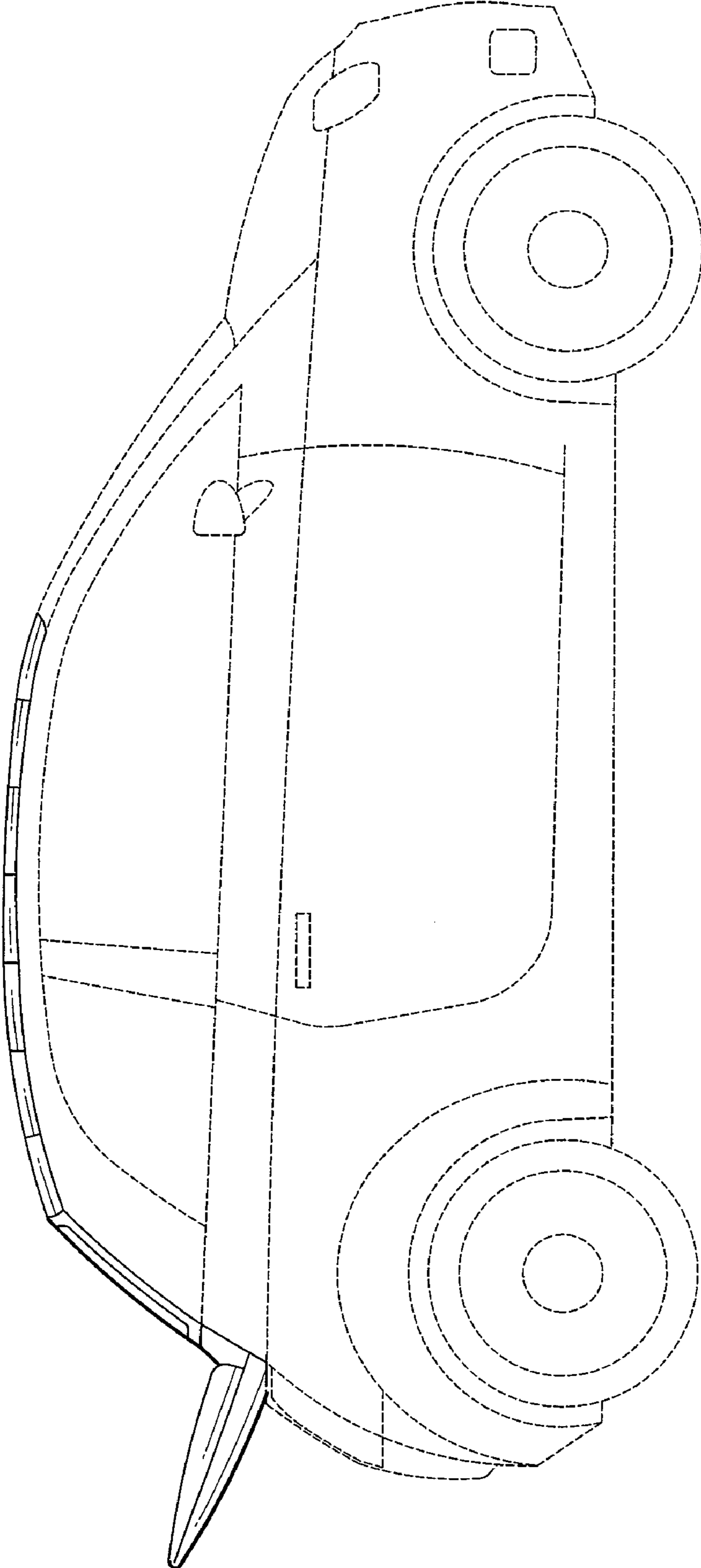

FIG.3

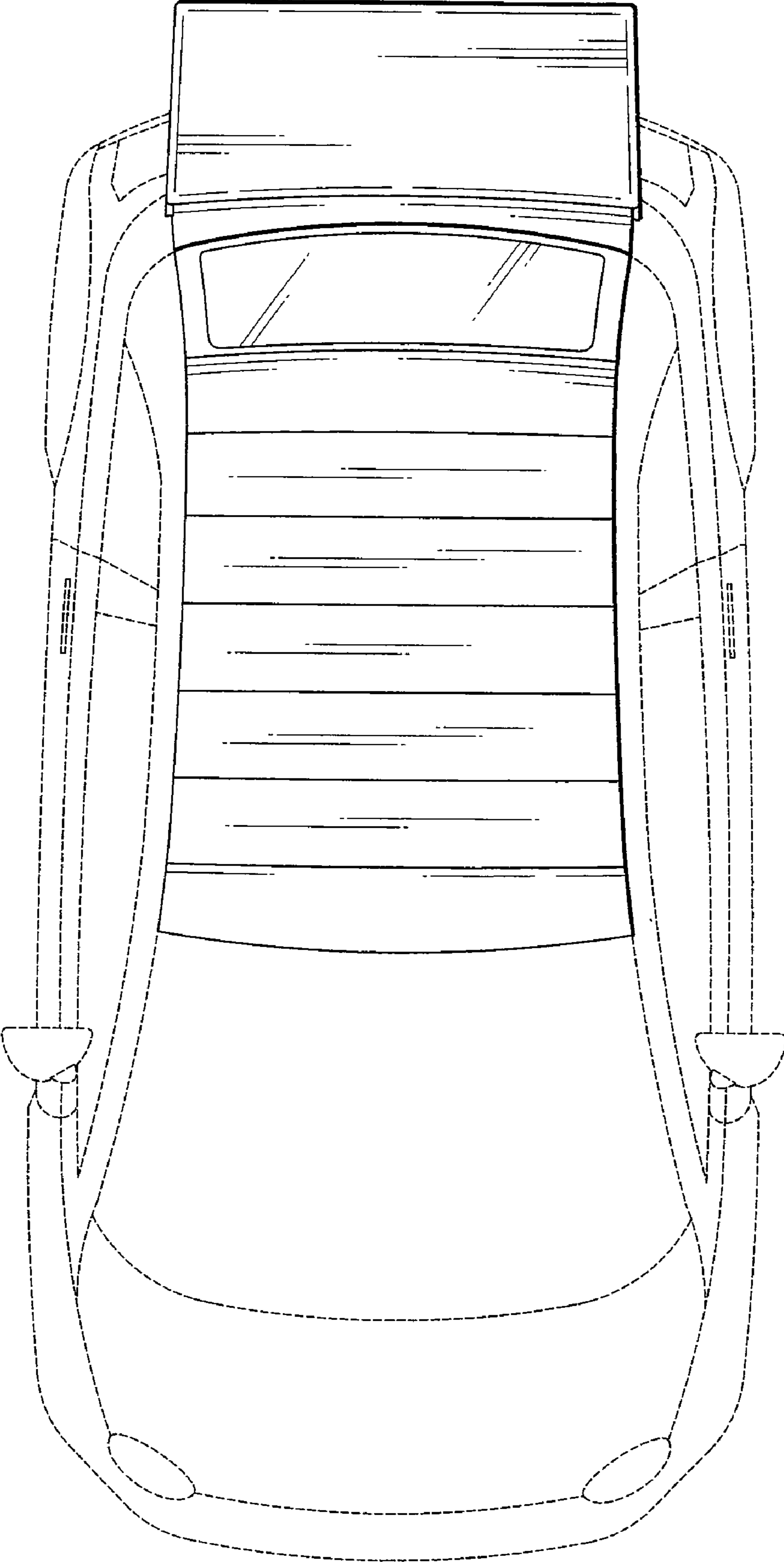

FIG.4

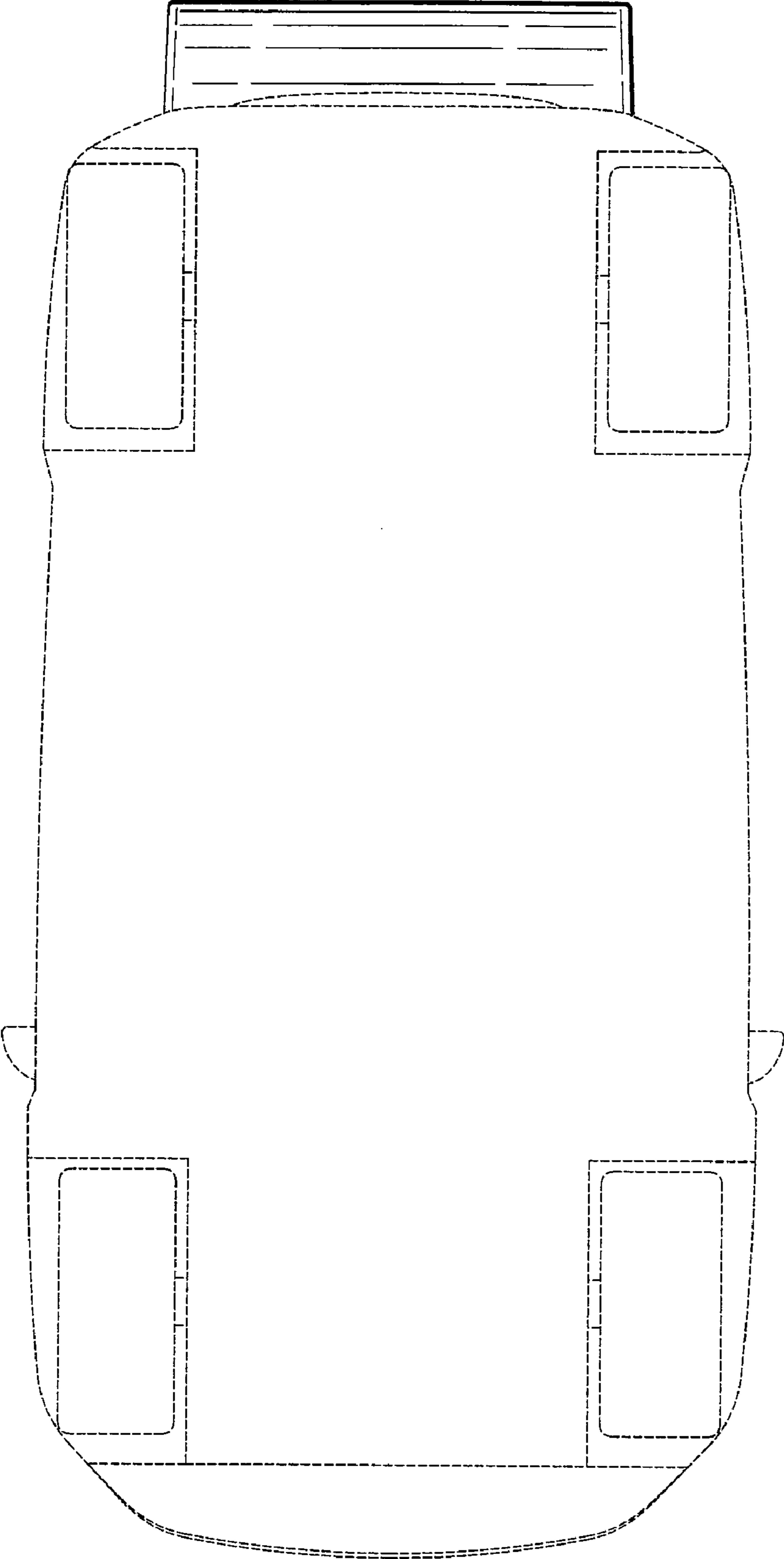

FIG.5

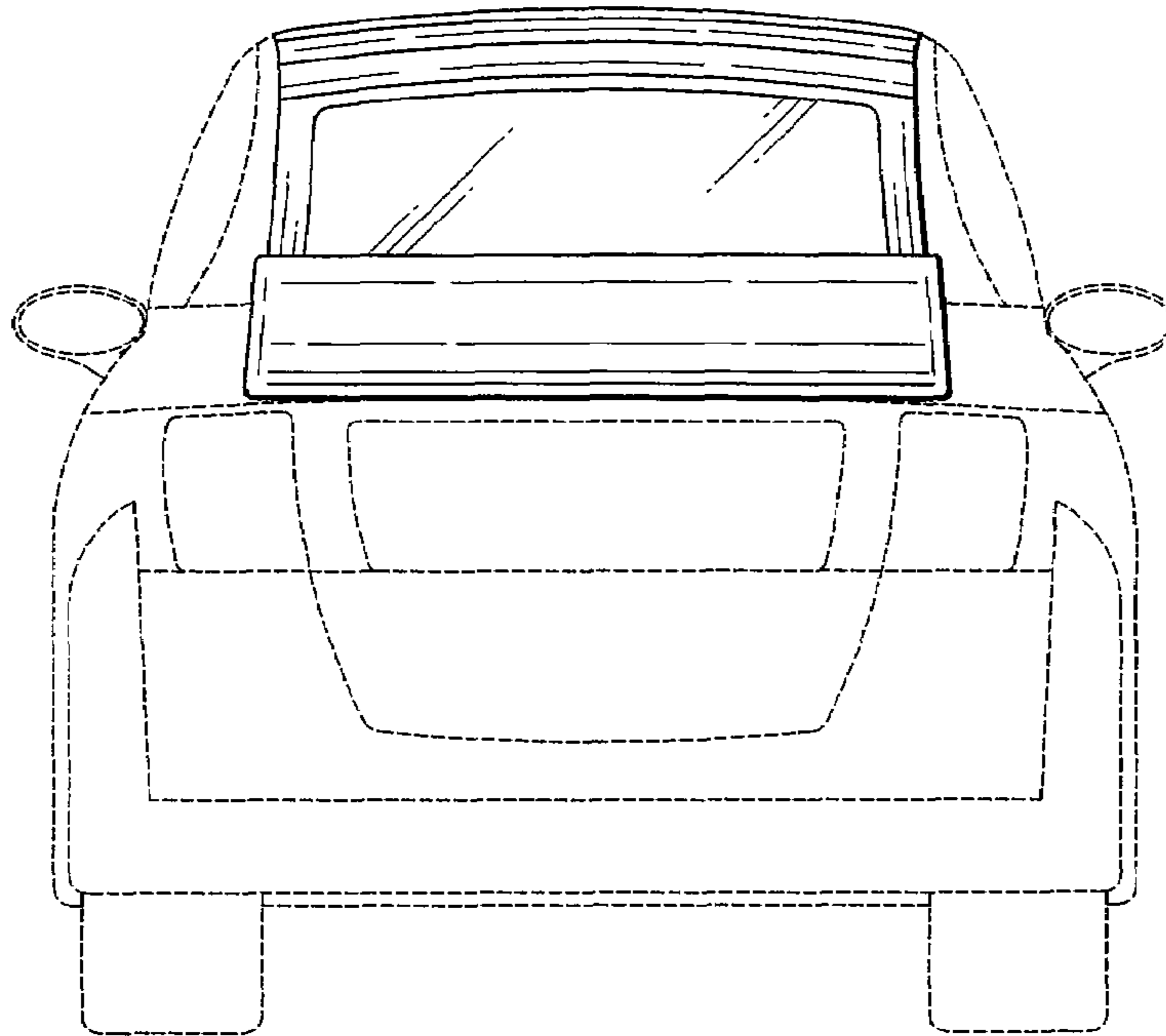

FIG. 6

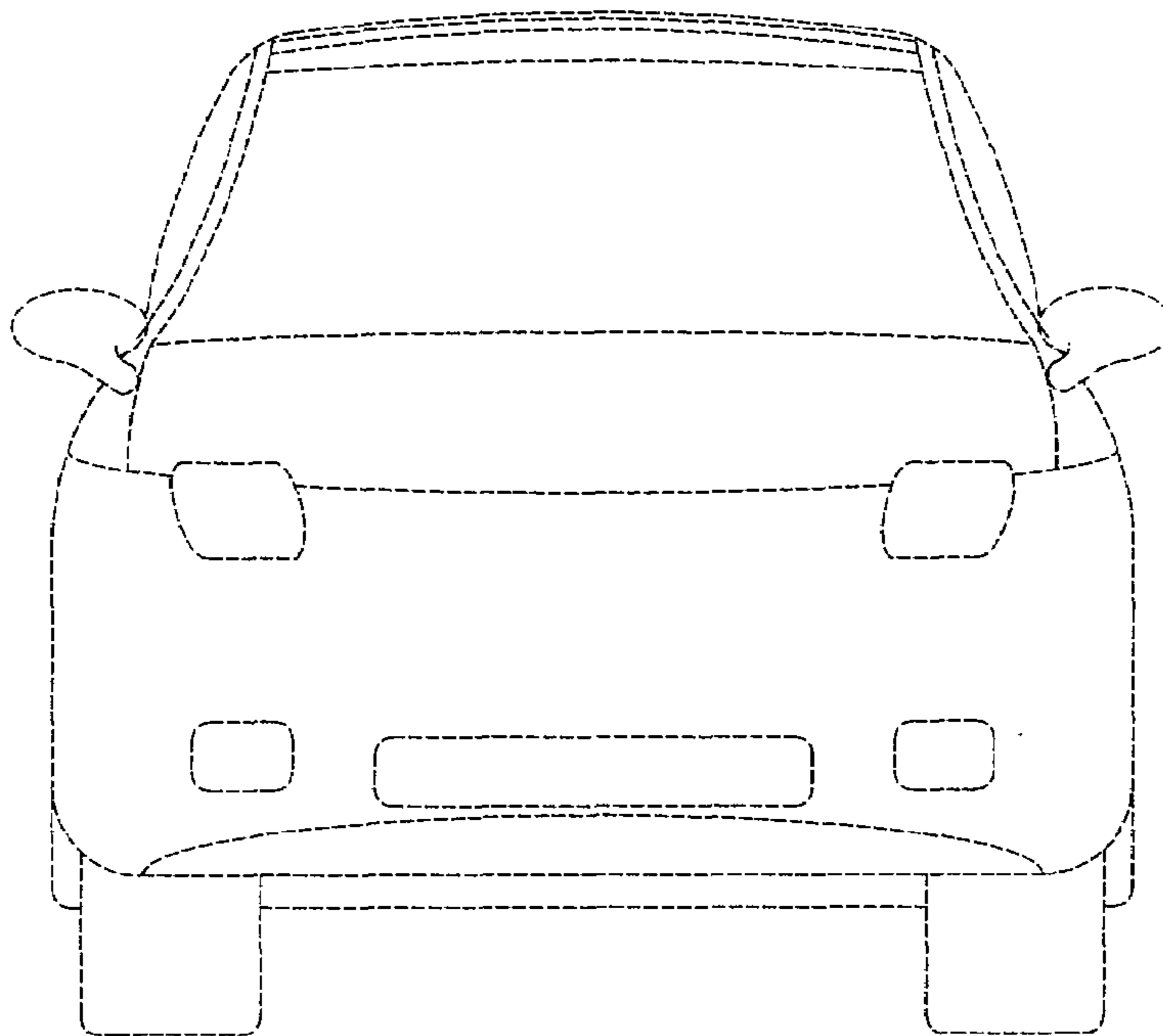

FIG. 7

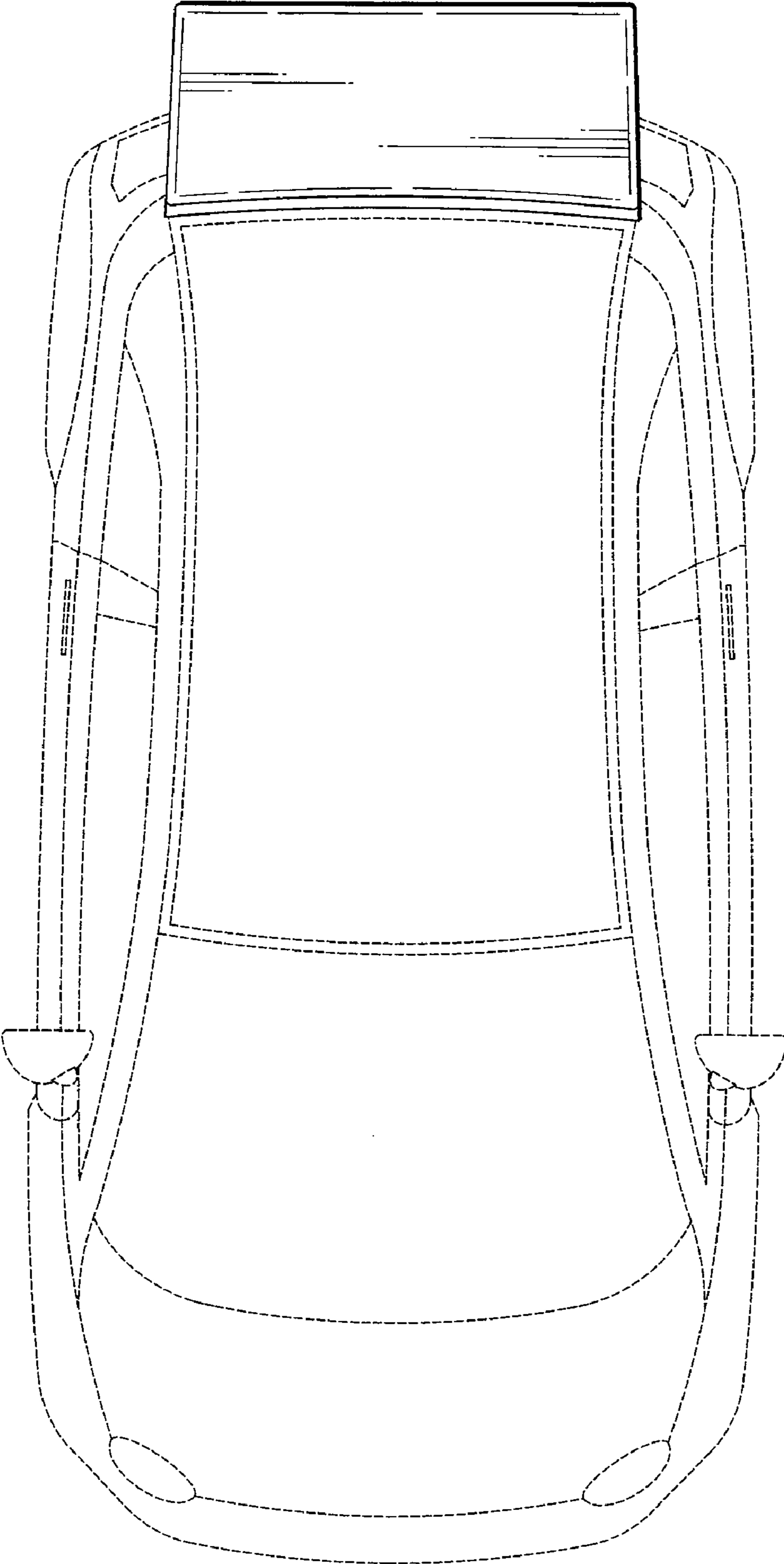

FIG.8

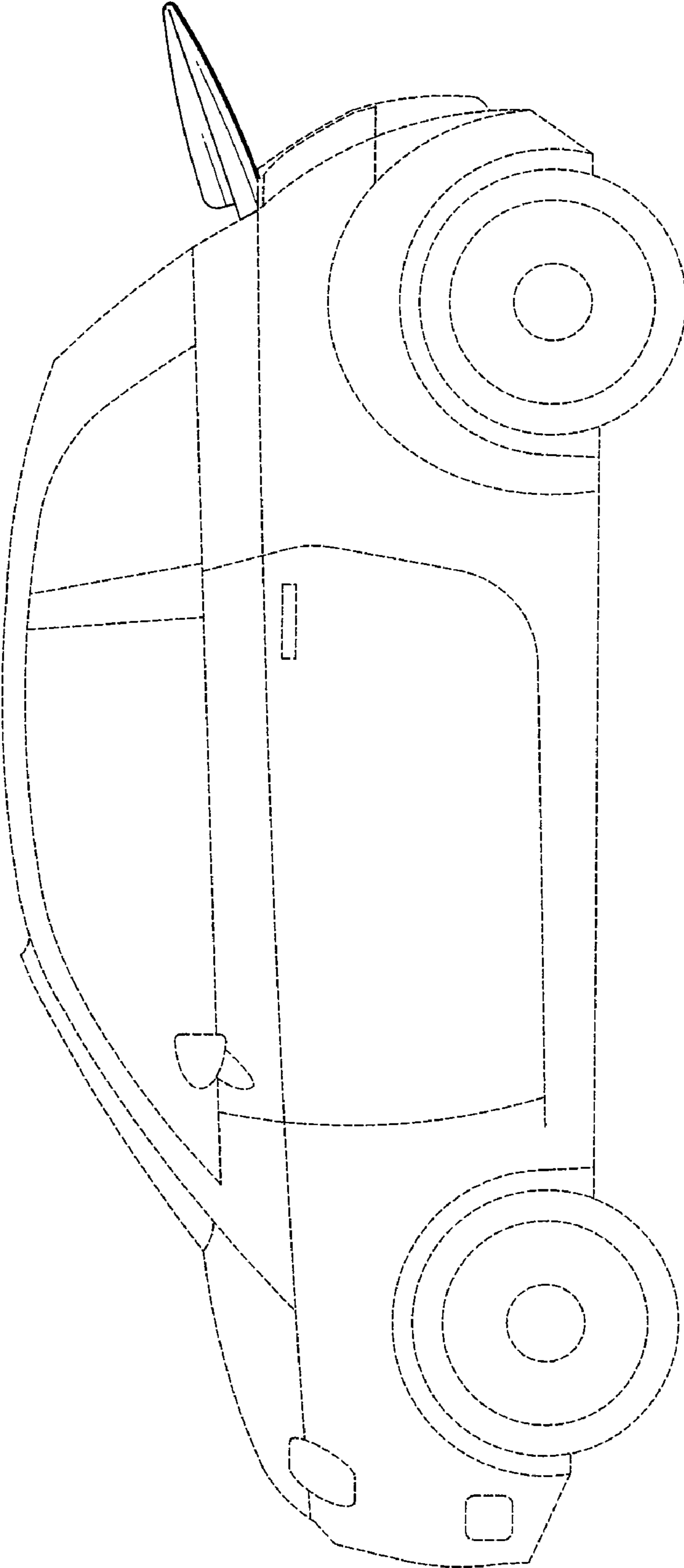

FIG.9

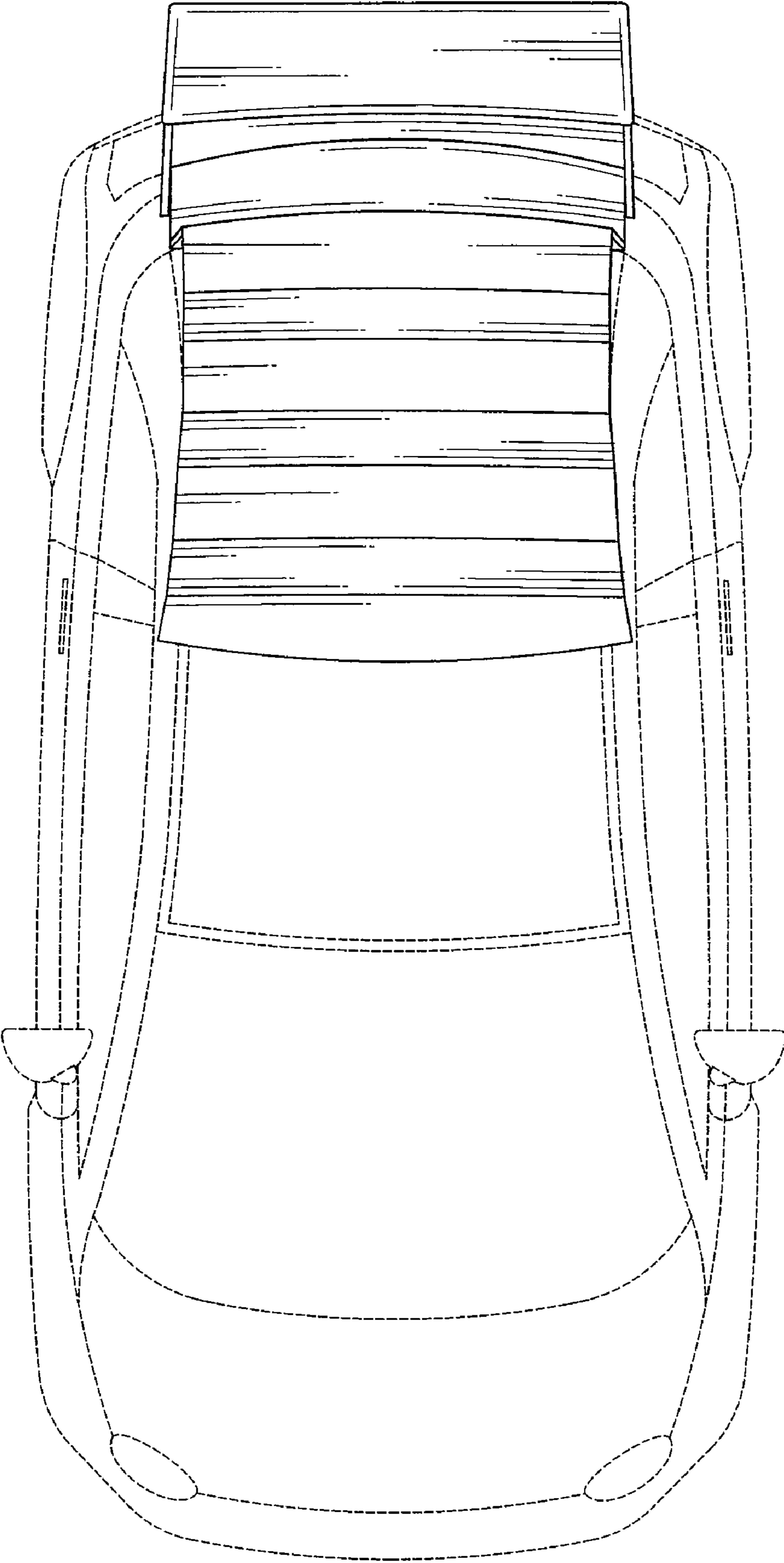

FIG.10

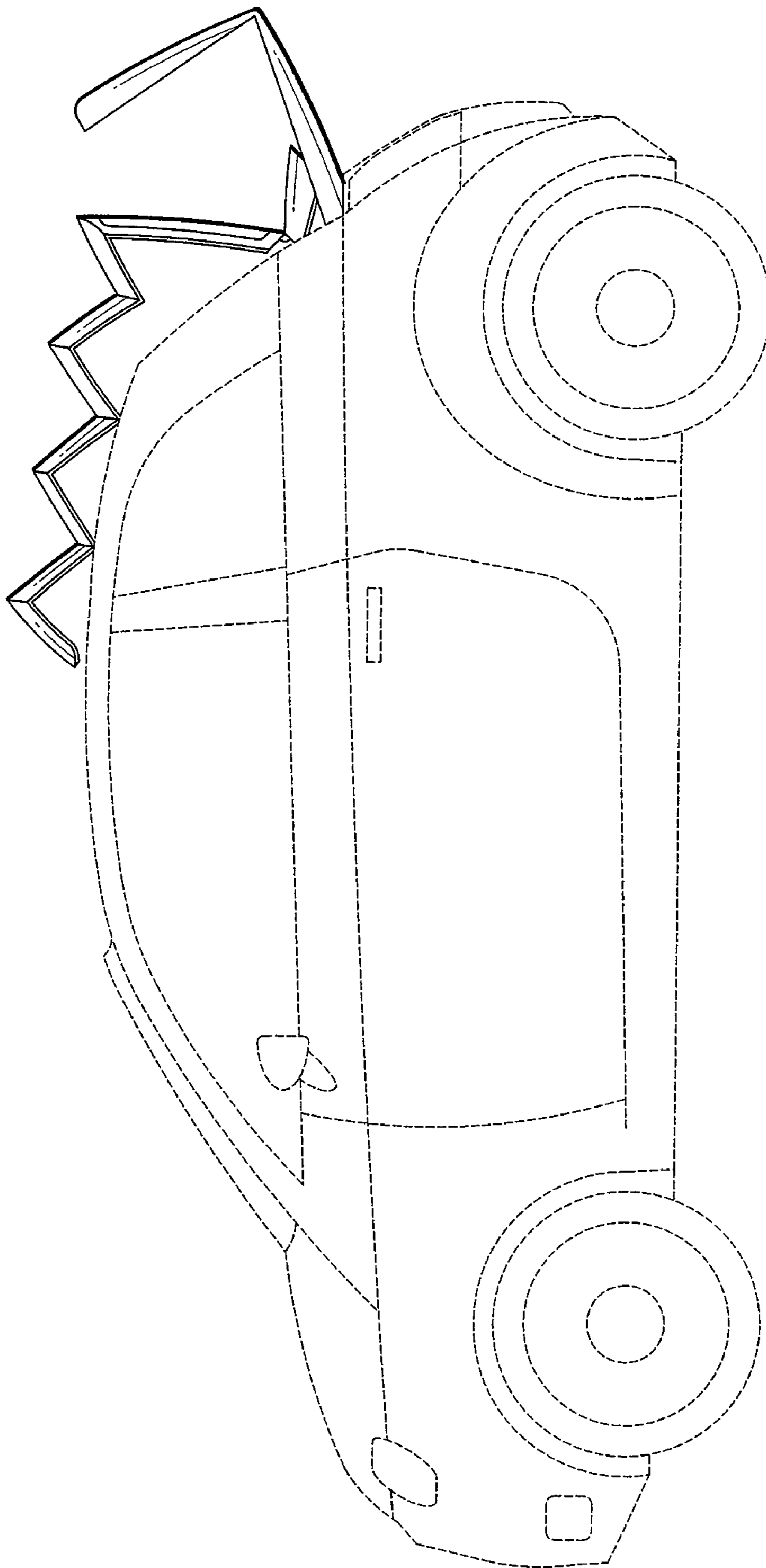

FIG.11