



US00D578452S

(12) **United States Design Patent**  
**Tabata et al.**

(10) **Patent No.:** **US D578,452 S**  
(45) **Date of Patent:** **\*\* Oct. 14, 2008**

(54) **BUMPER OF MOTOR VEHICLE**

D563,841 S \* 3/2008 Pfeiffer ..... D12/169

(75) Inventors: **Kouji Tabata**, Hiroshima (JP); **Kaname Sawai**, Hiroshima (JP); **Do Young Woo**, Hiroshima (JP); **Ryuichi Takaya**, Hiroshima (JP); **Hideki Nakamura**, Hiroshima (JP)

**FOREIGN PATENT DOCUMENTS**

JP 1240080 5/2005  
JP 1240130 5/2005  
JP 1296211 3/2007

(73) Assignee: **Mazda Motor Corporation** (JP)

Printout of media.mazda.com's website showing Mazda Motor Corp.'s "Mazda2", Feb. 20, 2007.

(\*\*) Term: **14 Years**

\* cited by examiner

(21) Appl. No.: **29/298,810**

*Primary Examiner*—Melody N Brown

(22) Filed: **Dec. 13, 2007**

(74) *Attorney, Agent, or Firm*—Studebaker & Brackett PC; Donald R. Studebaker

(30) **Foreign Application Priority Data**

(57) **CLAIM**

Jun. 29, 2007 (JP) ..... 2007-017406

The ornamental design for a bumper of motor vehicle, as shown and described.

(51) **LOC (8) Cl.** ..... **12-16**

(52) **U.S. Cl.** ..... **D12/169**

(58) **Field of Classification Search** ..... D12/169, D12/196, 171, 163, 216, 90-92, 86; 293/102, 293/113, 115, 117, 120; 296/180.1, 180.2  
See application file for complete search history.

**DESCRIPTION**

FIG. 1 is a perspective view of a bumper of motor vehicle;  
FIG. 2 is a front view thereof;  
FIG. 3 is a rear view thereof;  
FIG. 4 is a left side view thereof;  
FIG. 5 is a right side view thereof;  
FIG. 6 is a top view thereof; and,  
FIG. 7 is a bottom view thereof.

(56) **References Cited**

**U.S. PATENT DOCUMENTS**

D550,129 S \* 9/2007 Koizumi et al. .... D12/169  
D559,745 S \* 1/2008 Hieke ..... D12/169  
D561,073 S \* 2/2008 Okamoto et al. .... D12/169  
D561,660 S \* 2/2008 Tabata et al. .... D12/169

**1 Claim, 4 Drawing Sheets**

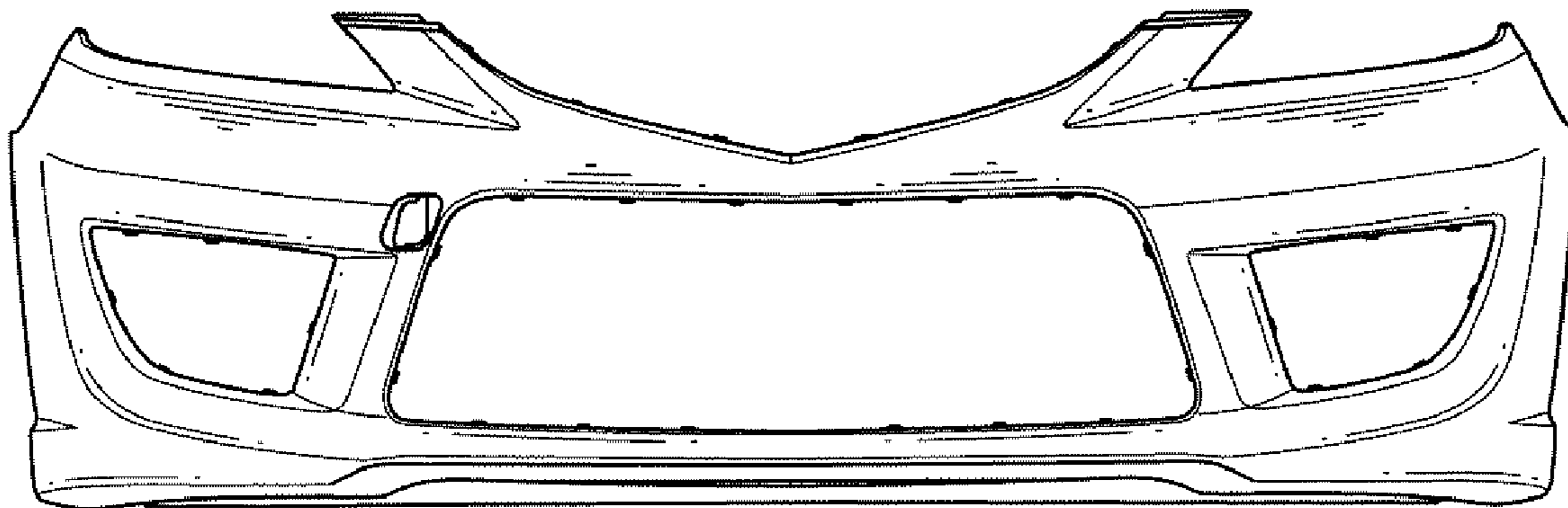

Fig.1

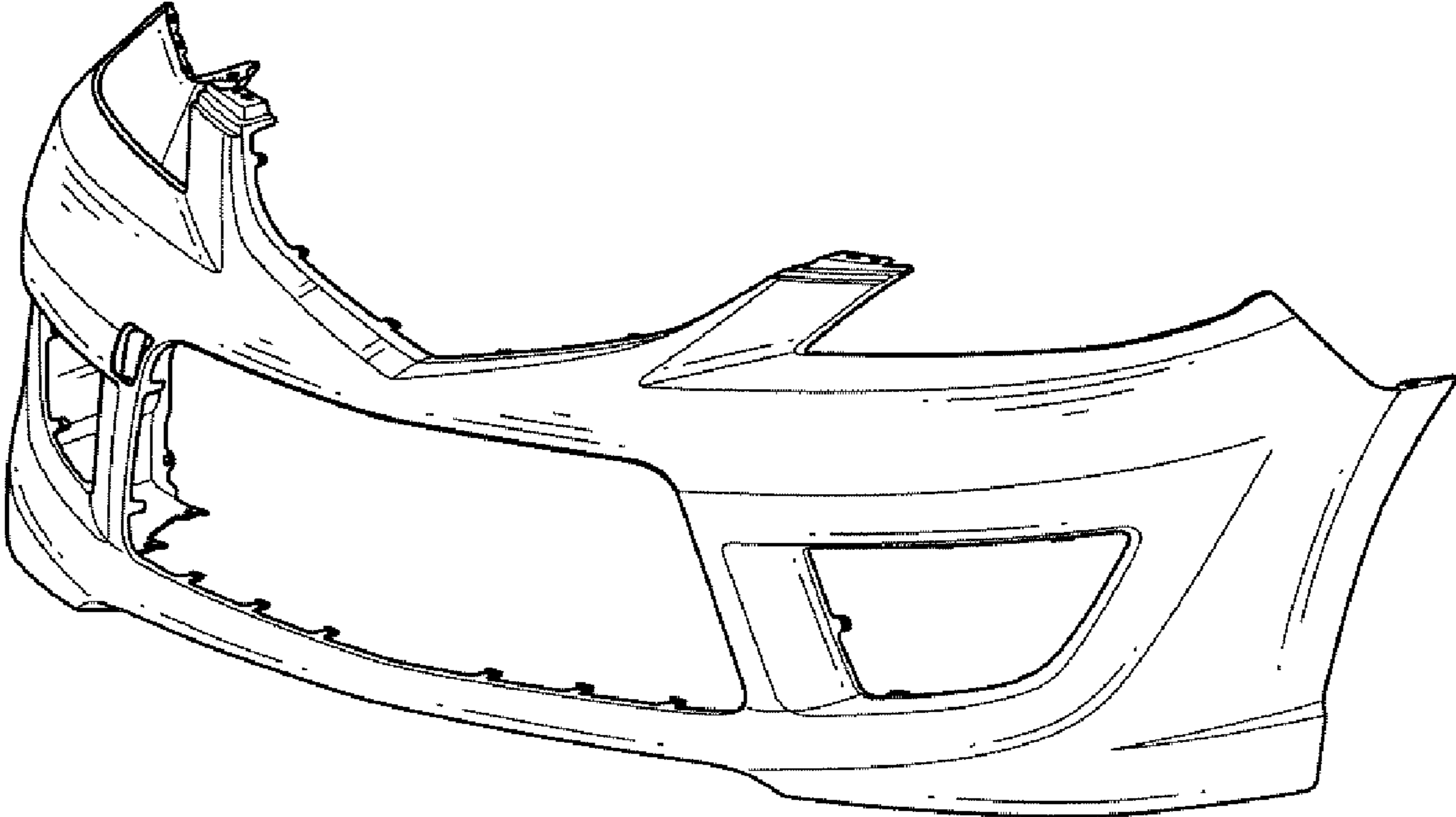

Fig.2

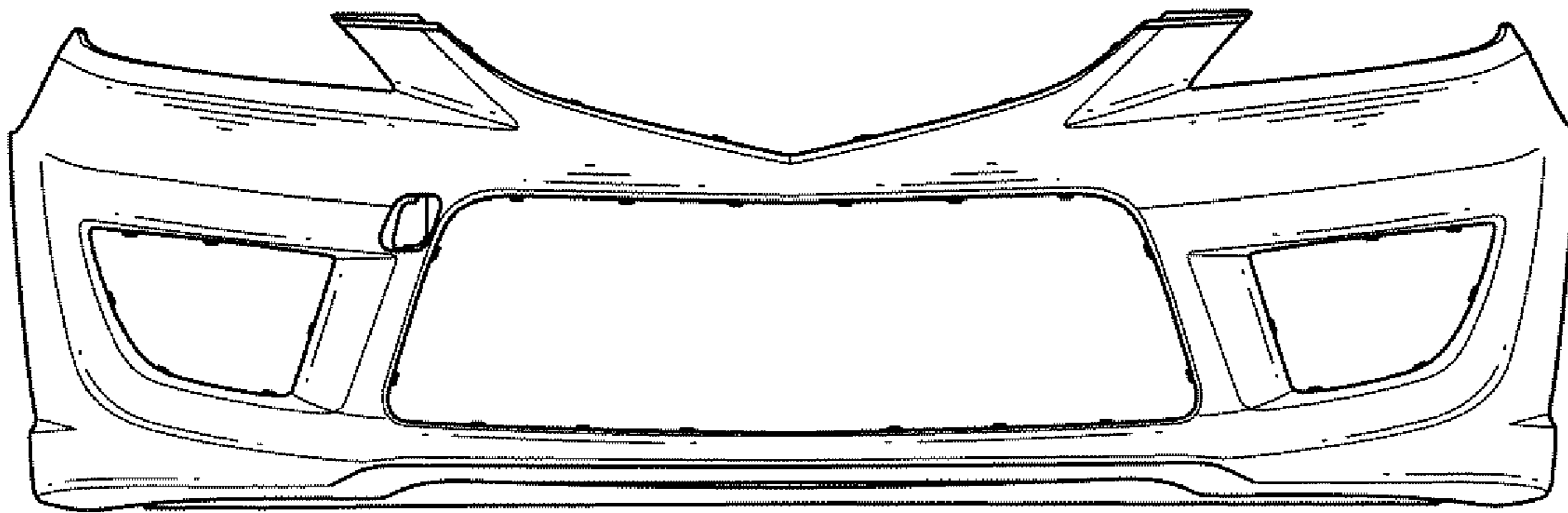

Fig.3

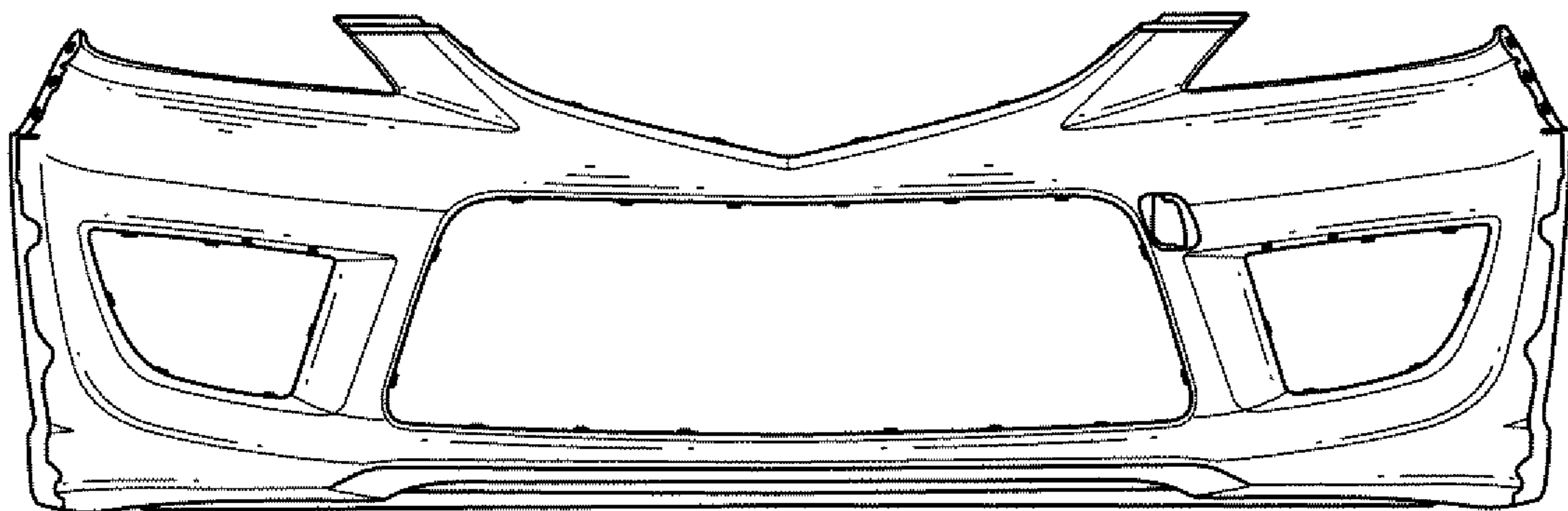

Fig.4

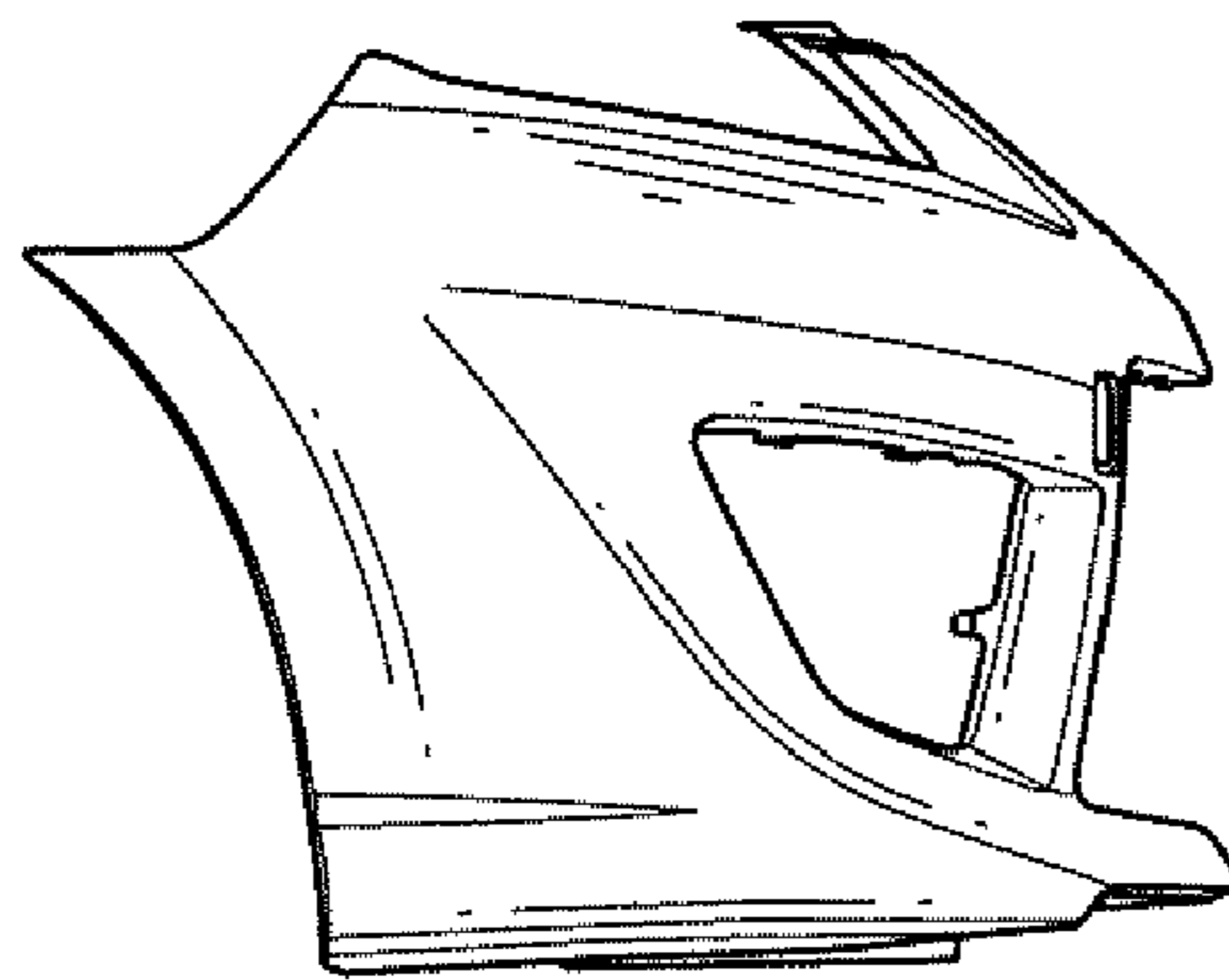

Fig.5

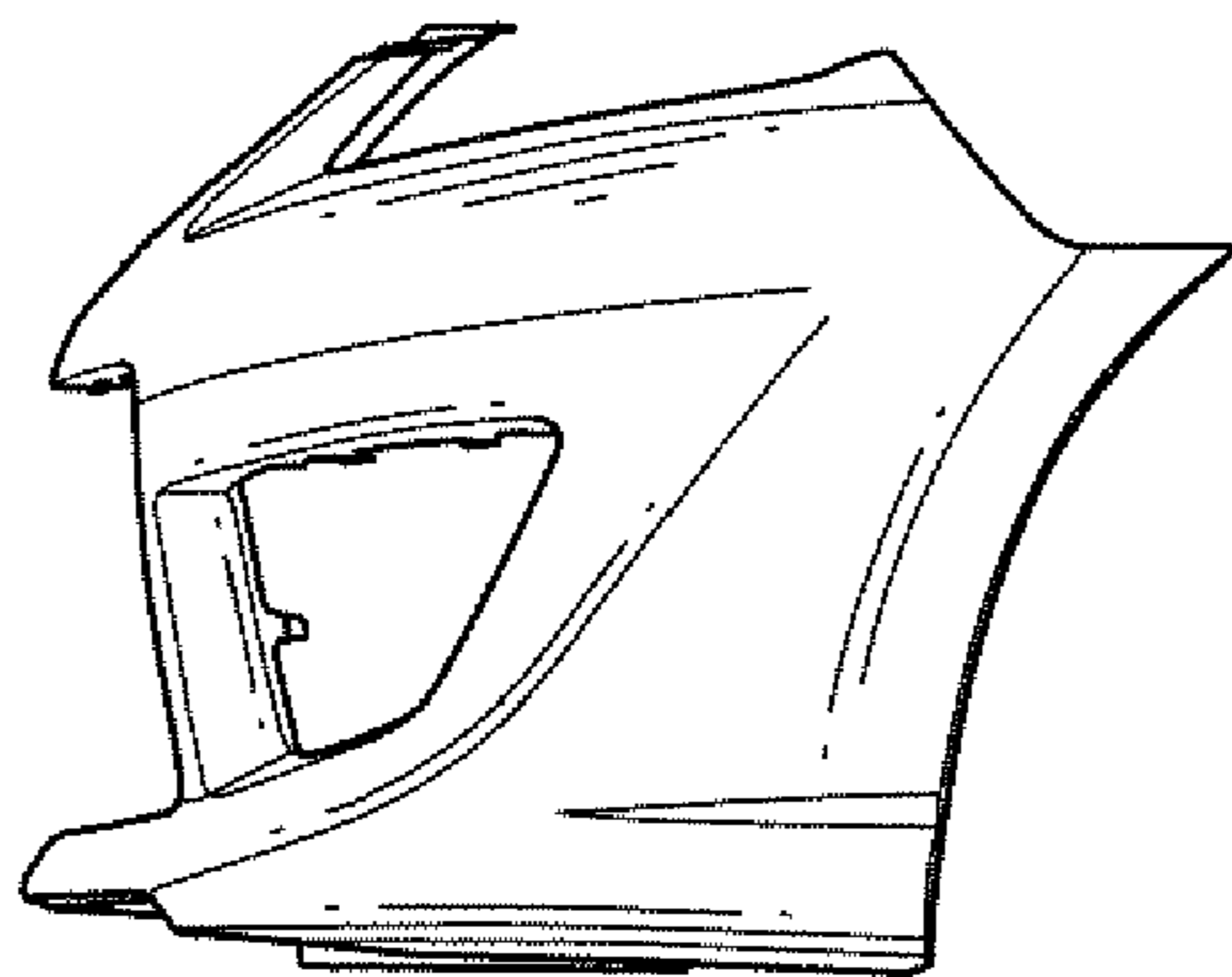

Fig.6

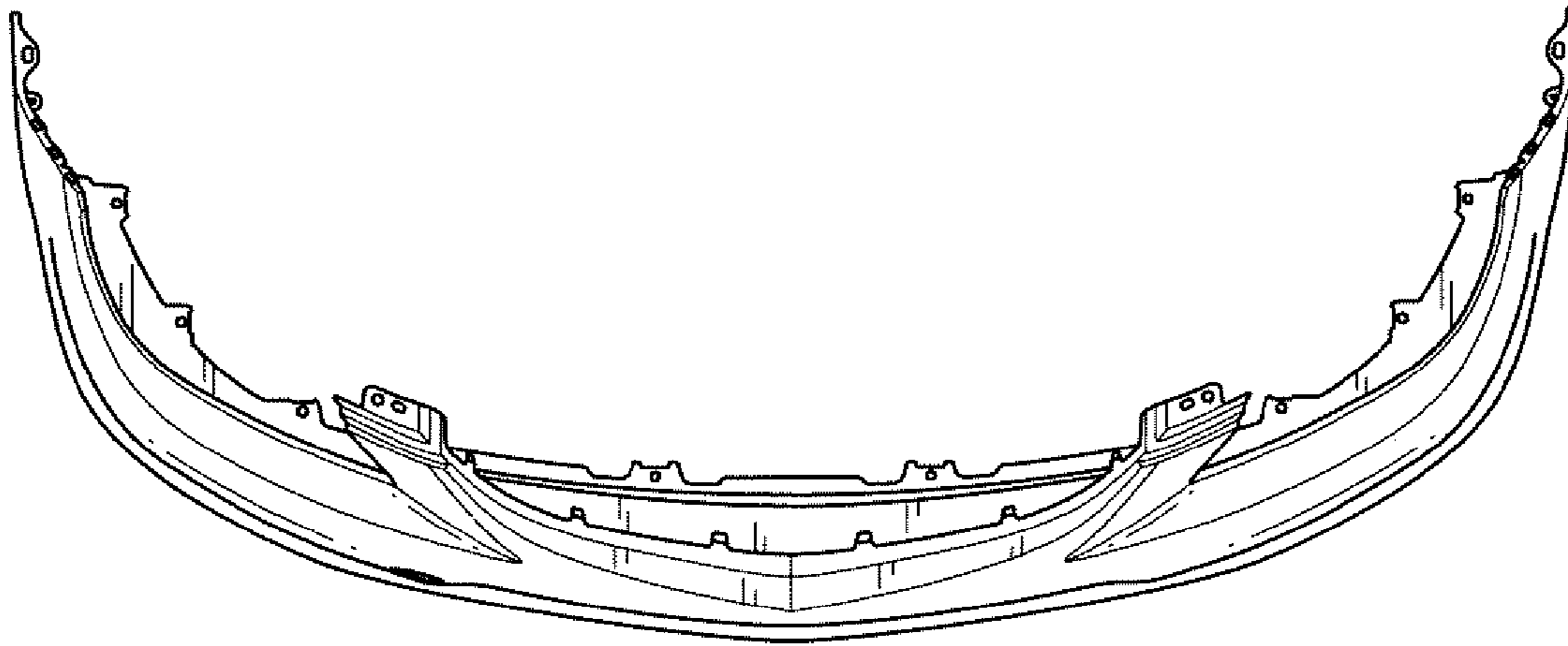

Fig.7

