



US00D578378S

(12) **United States Design Patent**
Huang

(10) **Patent No.:** **US D578,378 S**
(45) **Date of Patent:** **** Oct. 14, 2008**

(54) **BRACKET SUPPORTED DISPLAY**

(74) *Attorney, Agent, or Firm*—Paul M. Denk

(76) **Inventor:** **Sunny En Liung Huang**, 786 Via Monte Video, Claremont, CA (US) 91711

(57) **CLAIM**

The ornamental design for the bracket supported display, as shown and described.

(**) **Term:** **14 Years**

(21) **Appl. No.:** **29/289,008**

DESCRIPTION

(22) **Filed:** **Jun. 29, 2007**

FIG. 1 provides a perspective view of the first embodiment of the bracket supported display of this invention;

(51) **LOC (8) Cl.** **08-05**

FIG. 2 is a front view thereof;

(52) **U.S. Cl.** **D8/349**

FIG. 3 is a rear view;

(58) **Field of Classification Search** D8/349,
D8/354; D6/553, 495; 211/30, 32, 86.01,
211/55; 248/354.3, 188.8, 86.01, 298.1
See application file for complete search history.

FIG. 4 is a left side view;

FIG. 5 is a right side view;

FIG. 6 top view; and,

FIG. 7 is a bottom view.

(56) **References Cited**

FIG. 8 is a perspective view of the second embodiment of the bracket supported display of this invention;

U.S. PATENT DOCUMENTS

FIG. 9 is a front view thereof;

D242,613	S	*	12/1976	Prather	D34/31
D273,447	S	*	4/1984	Capers, Jr.	D6/553
D334,133	S	*	3/1993	Hartzheim	D8/354
5,303,829	A	*	4/1994	Kennedy	211/30
D394,199	S	*	5/1998	Hodges	D8/349
D478,748	S	*	8/2003	Liu	D6/495
D513,965	S	*	1/2006	Bonnell	D8/354

FIG. 10 is a rear view;

FIG. 11 is a left side view;

FIG. 12 is a right side view;

FIG. 13 top view; and,

FIG. 14 is a bottom view.

* cited by examiner

Primary Examiner—Holly H Baynham

1 Claim, 2 Drawing Sheets

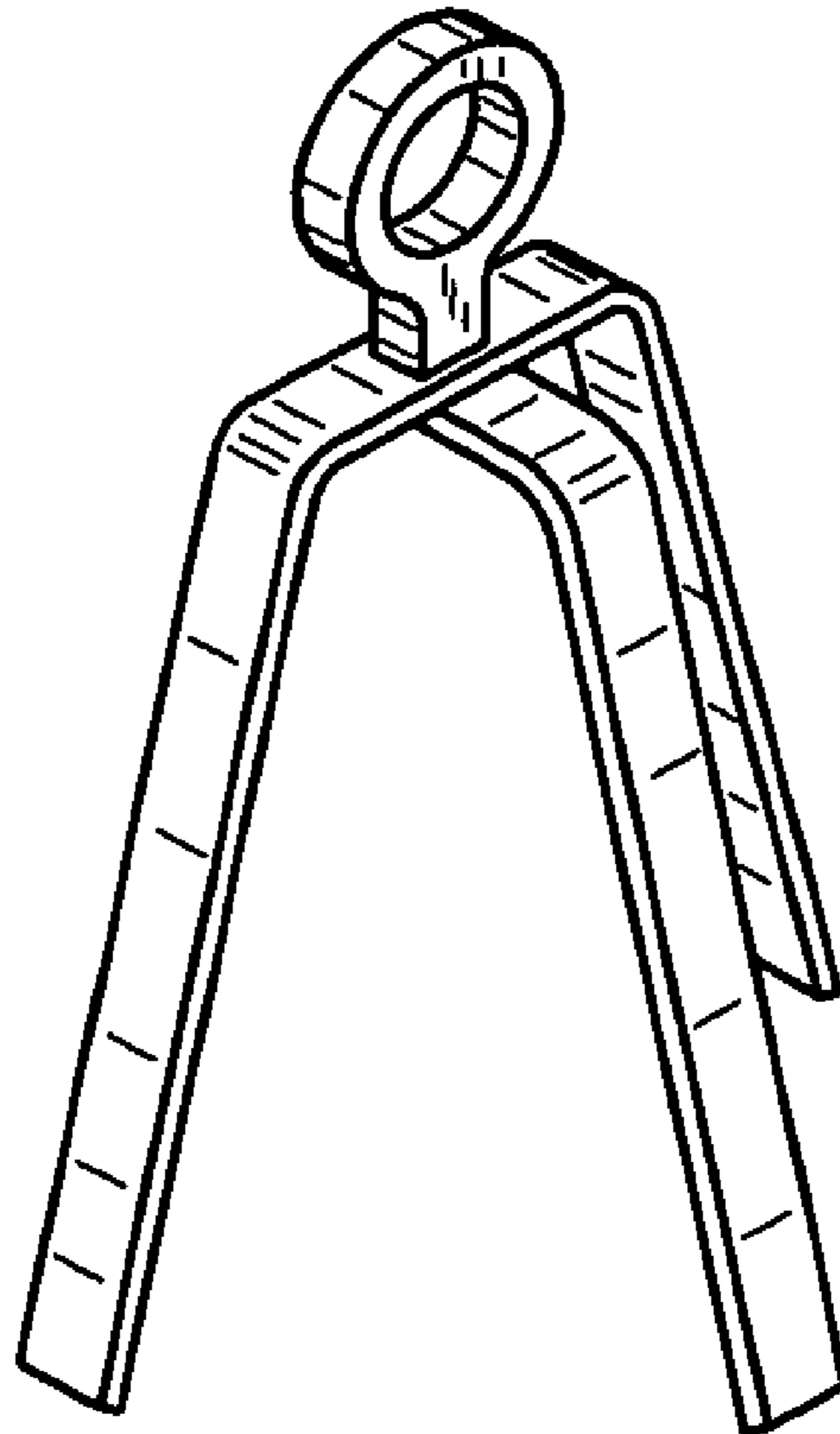

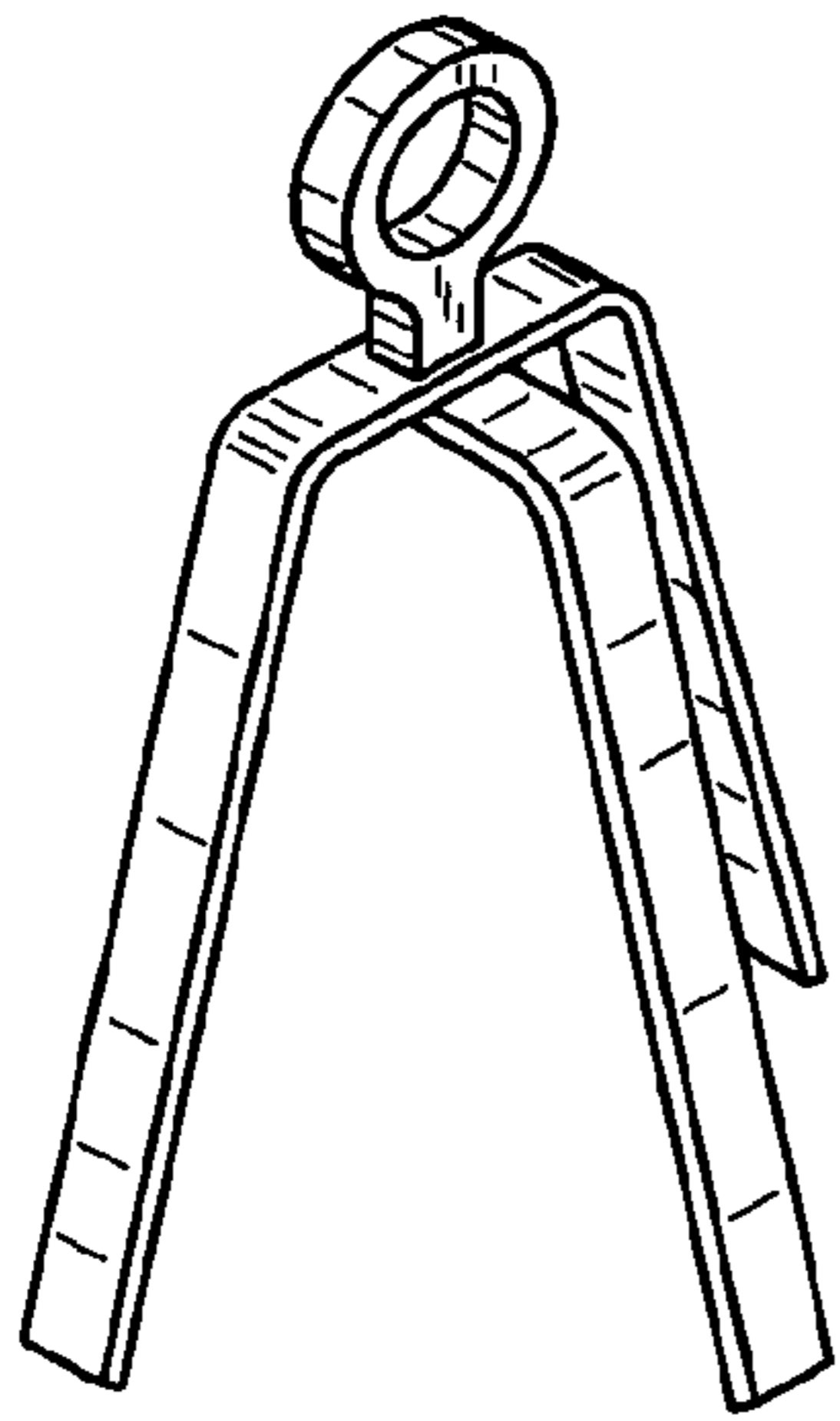

FIG. 1

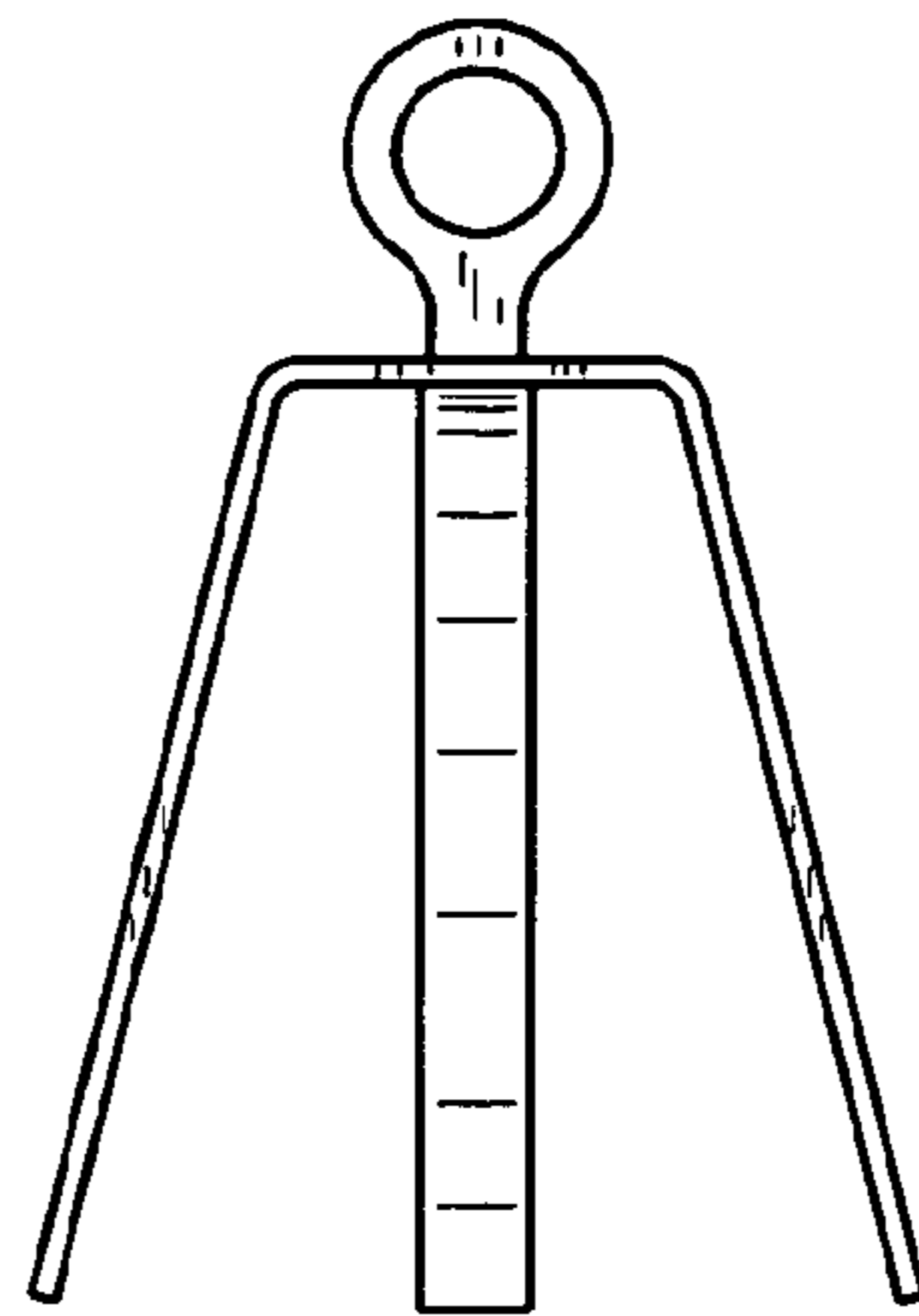

FIG. 2

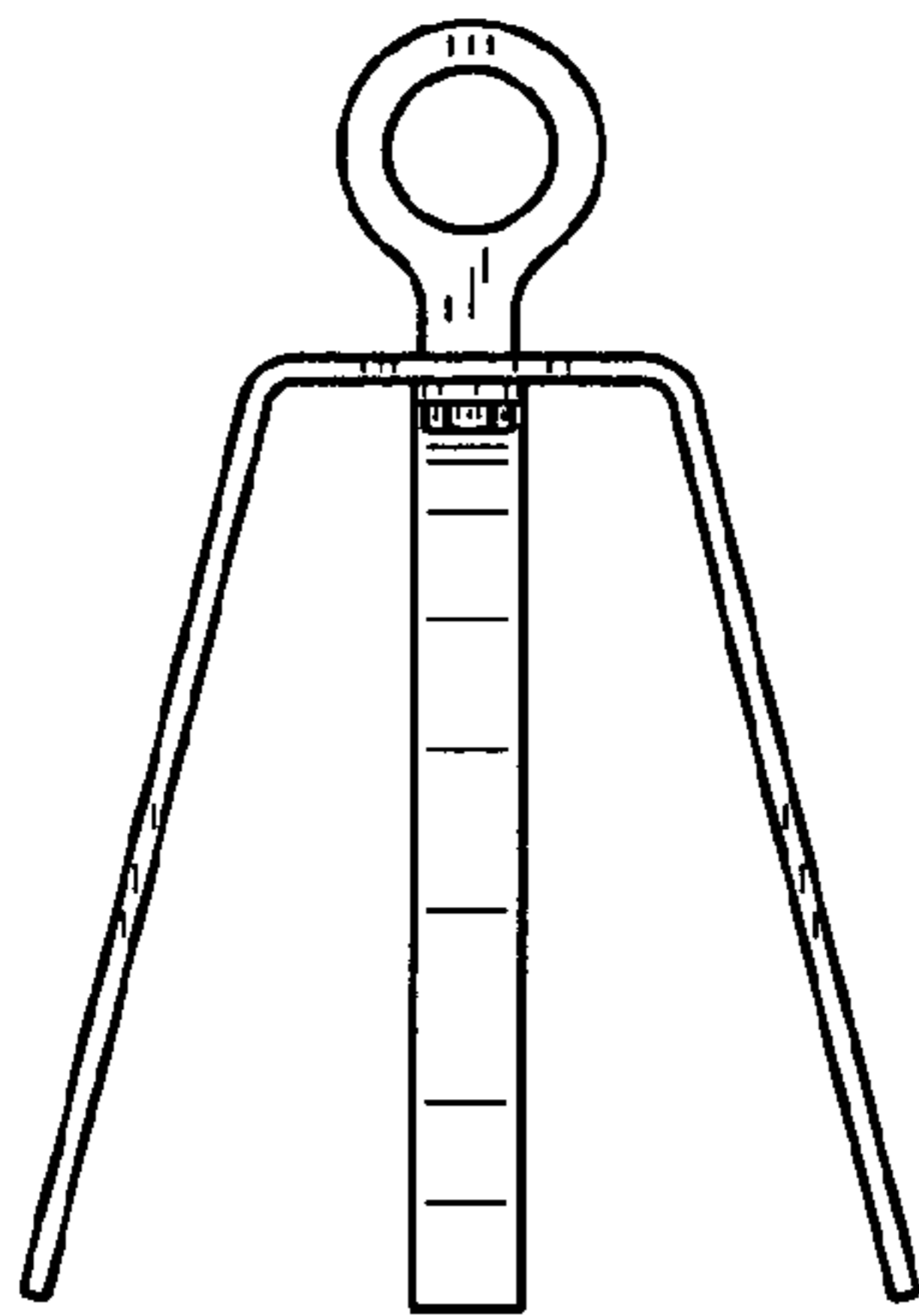

FIG. 3

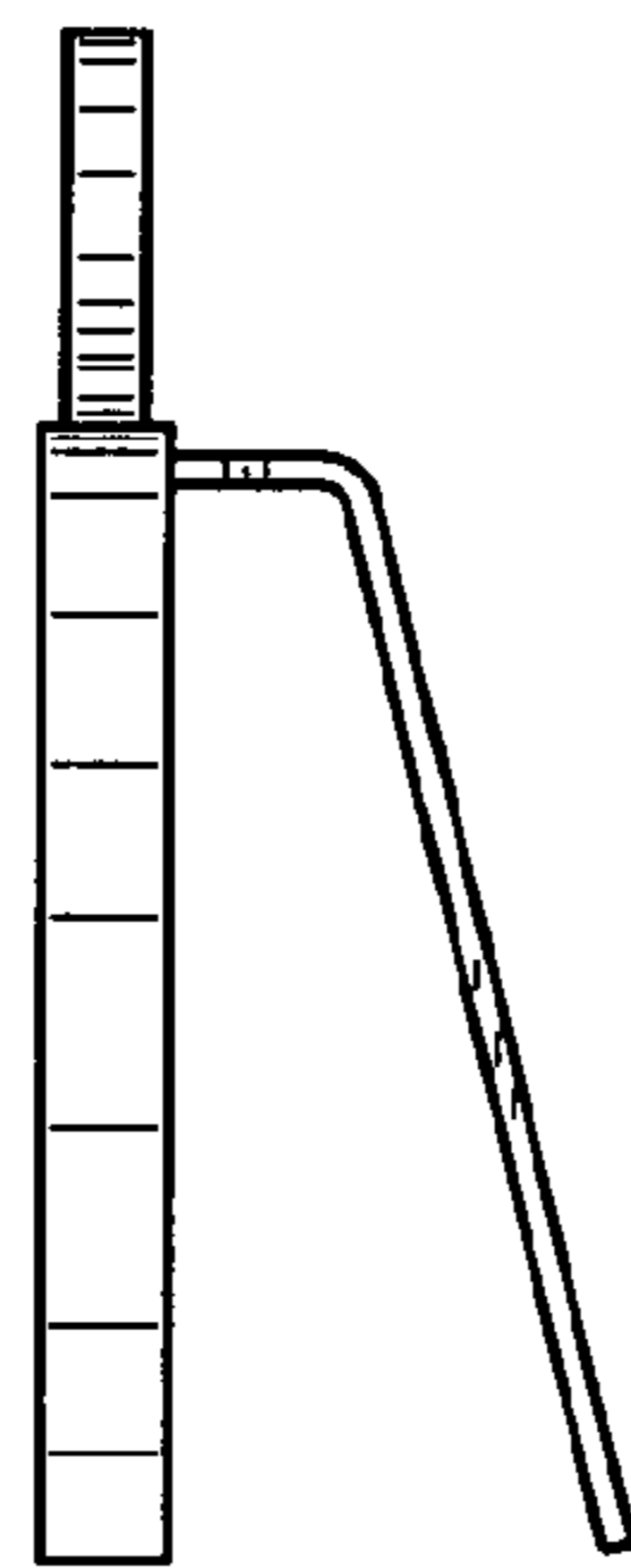

FIG. 4

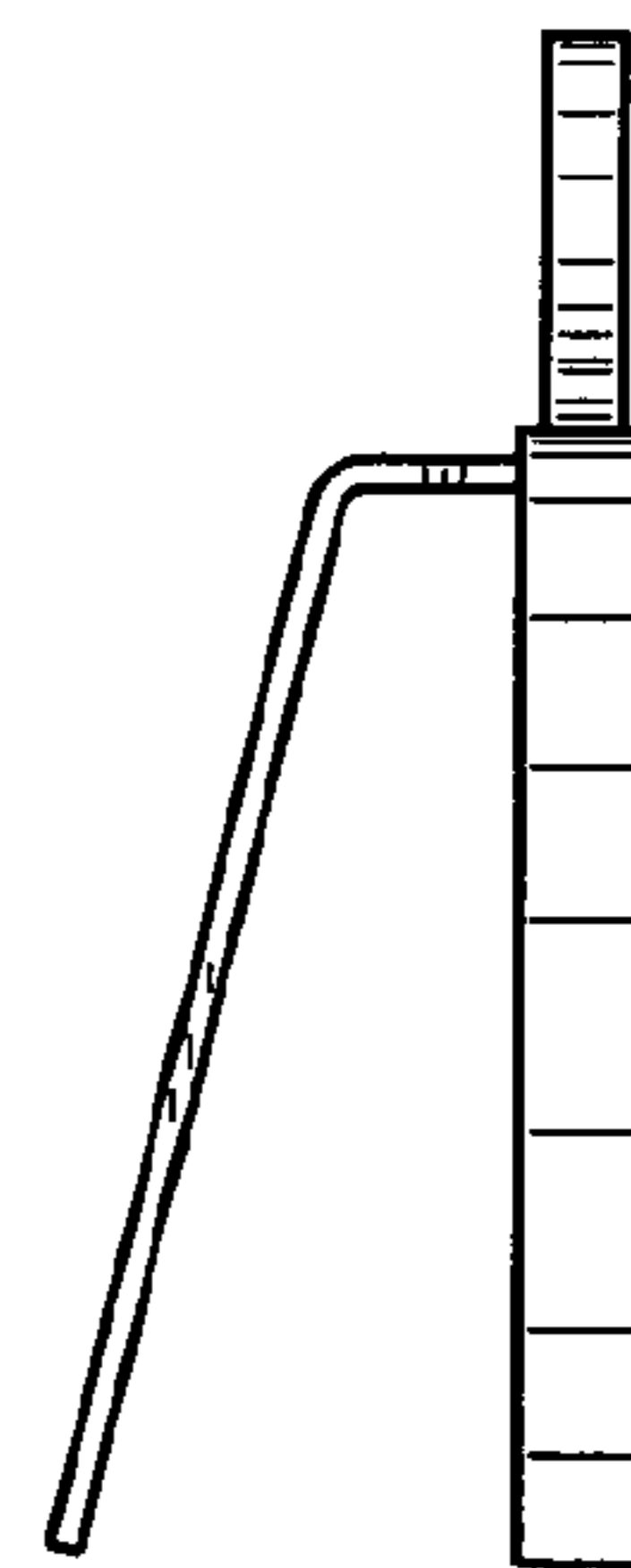

FIG. 5

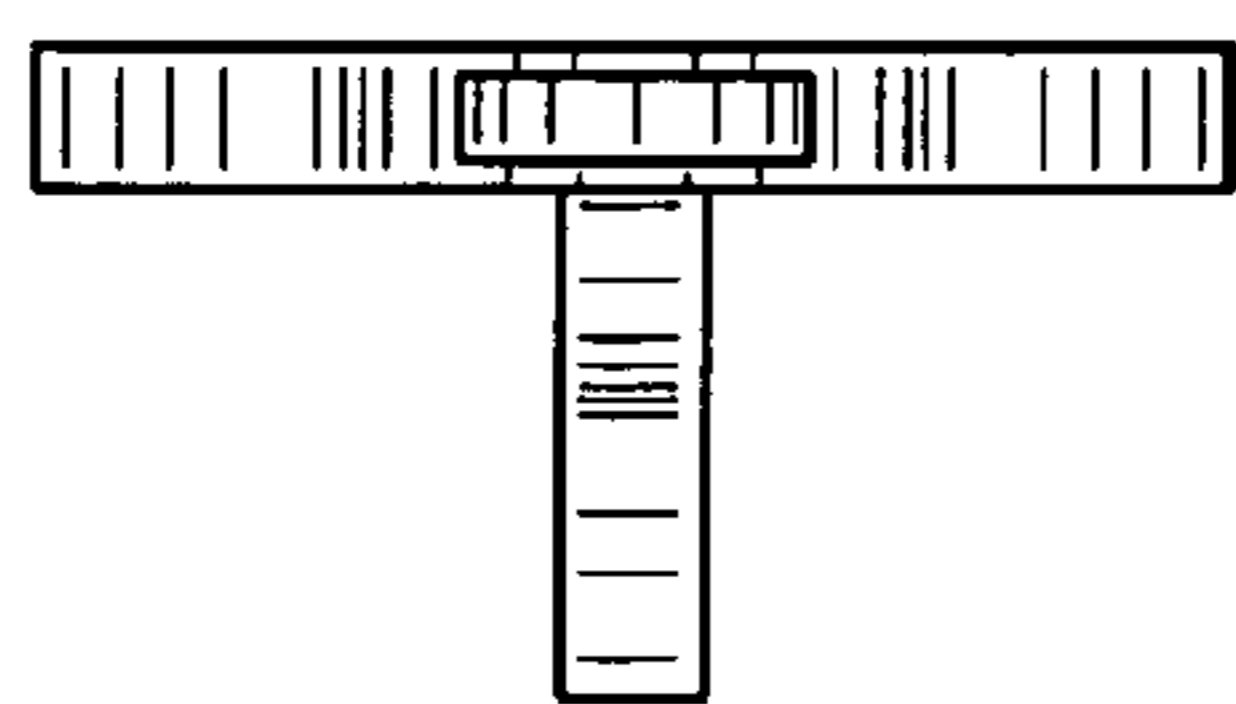

FIG. 6

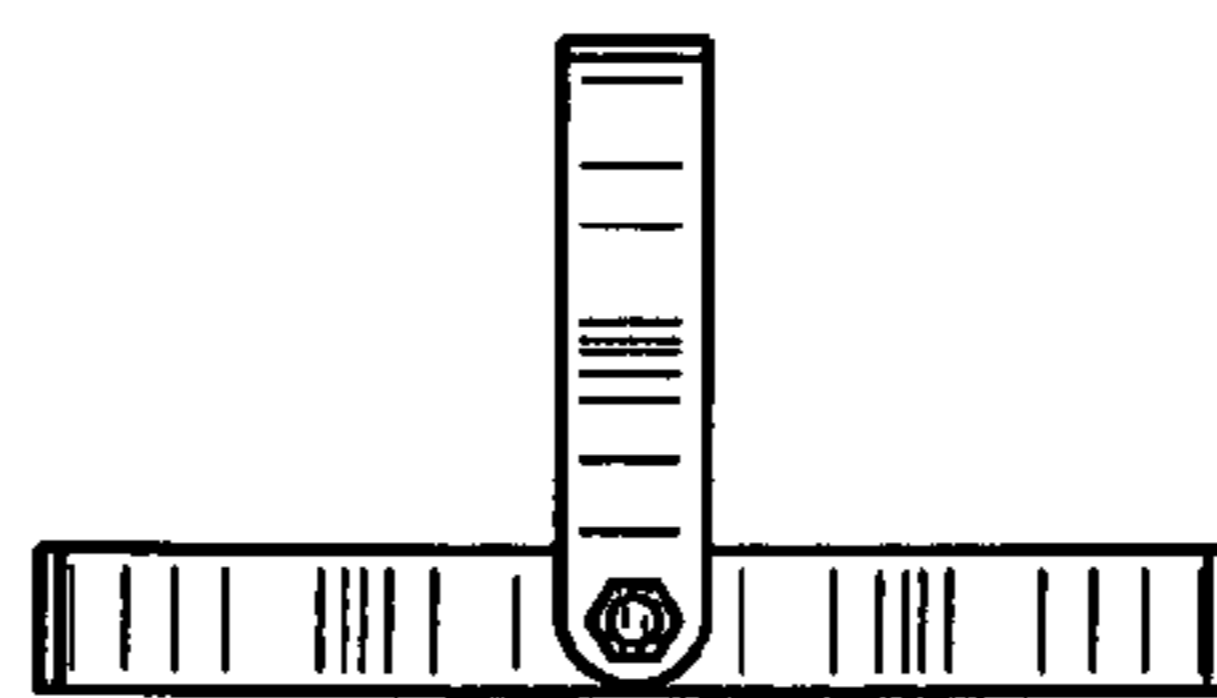

FIG. 7

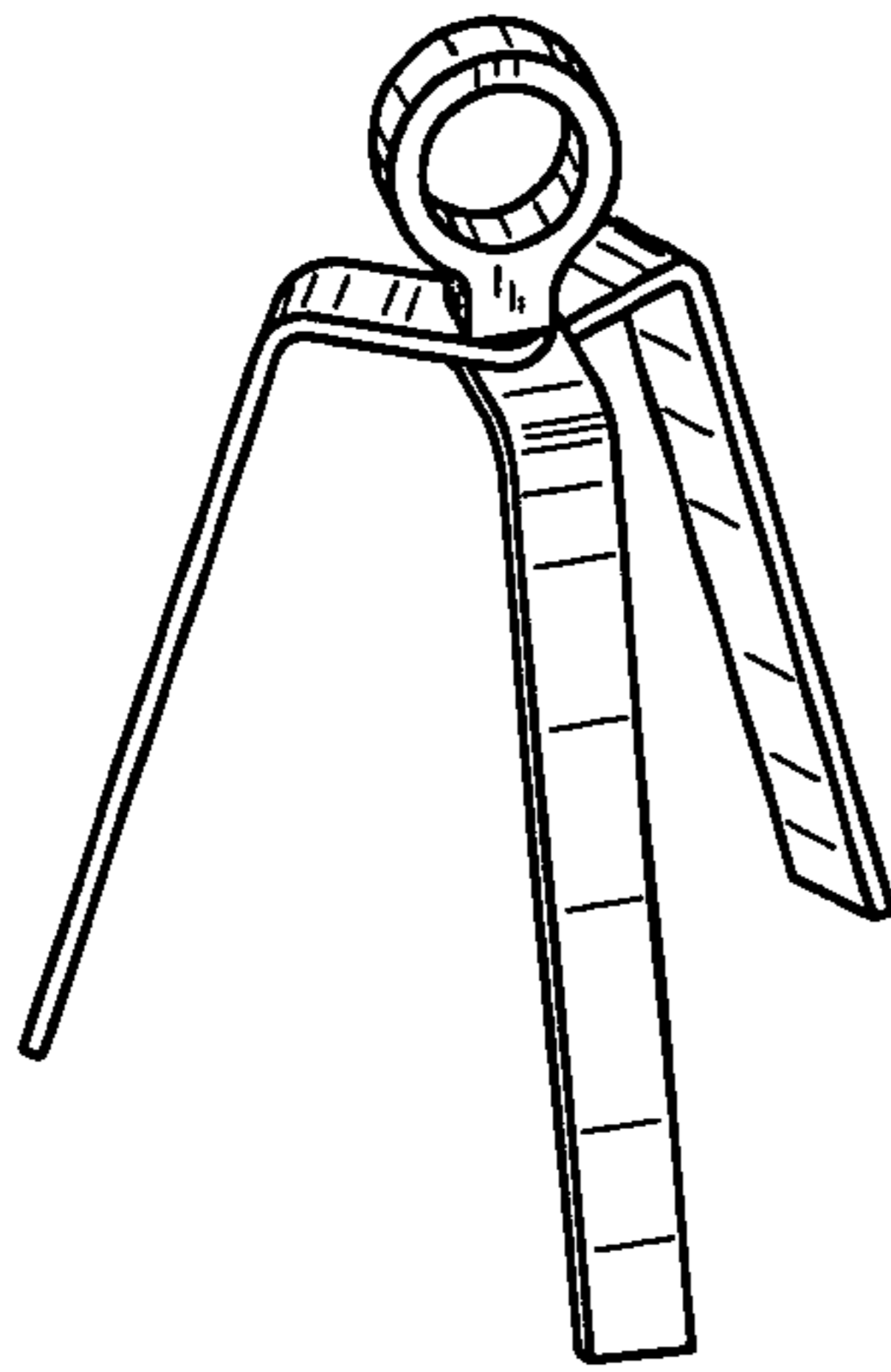

FIG. 8

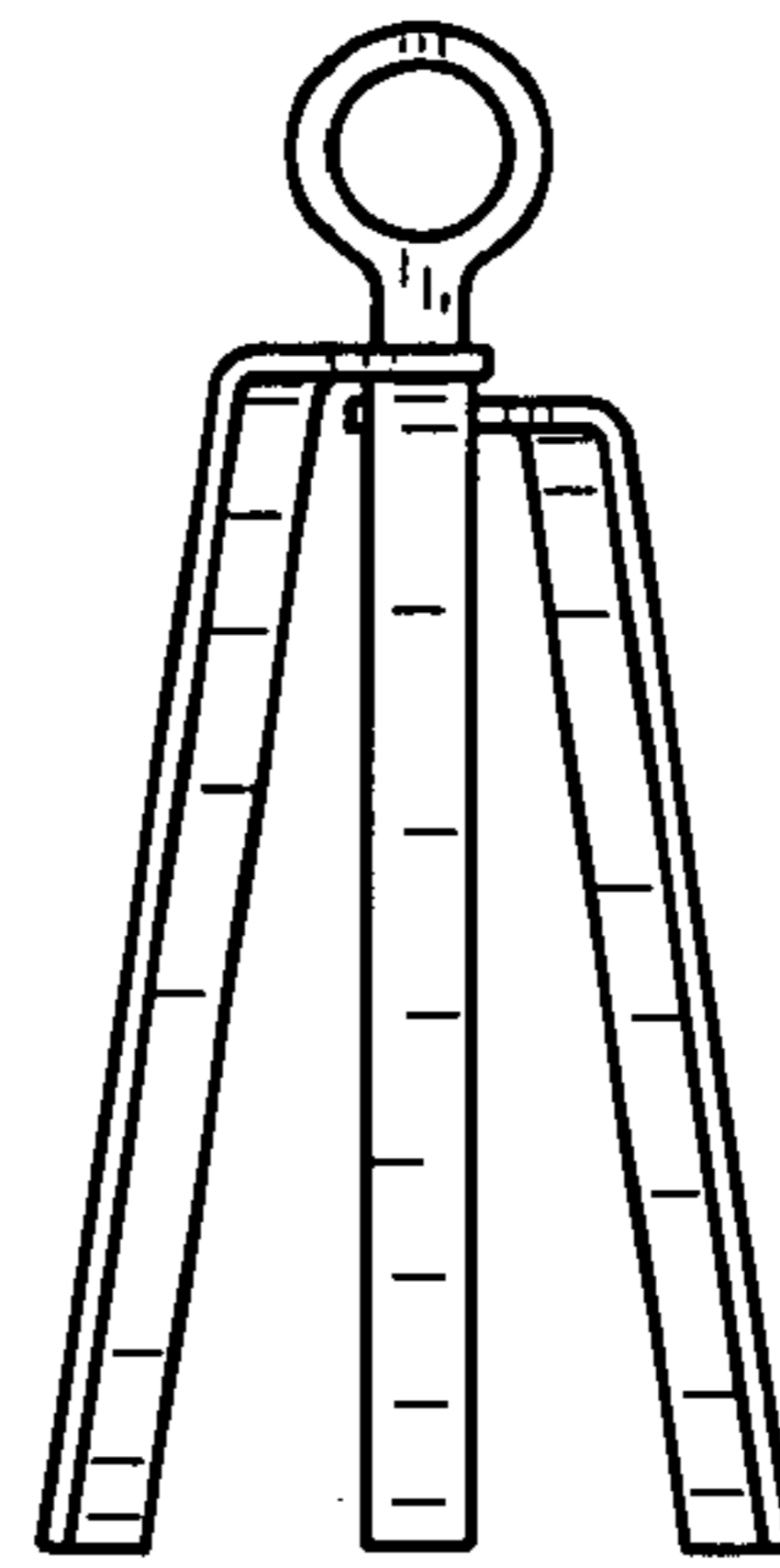

FIG. 9

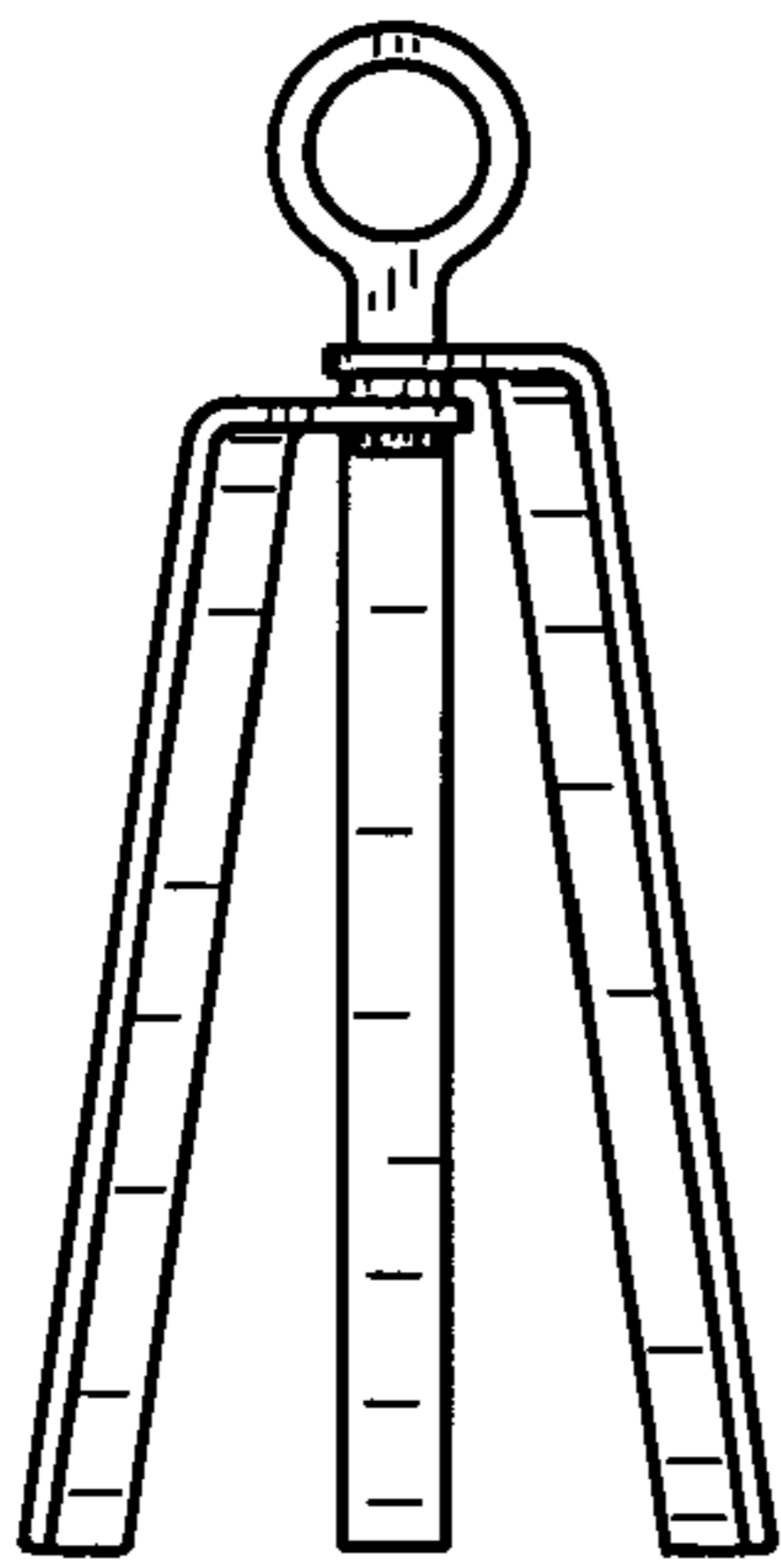

FIG. 10

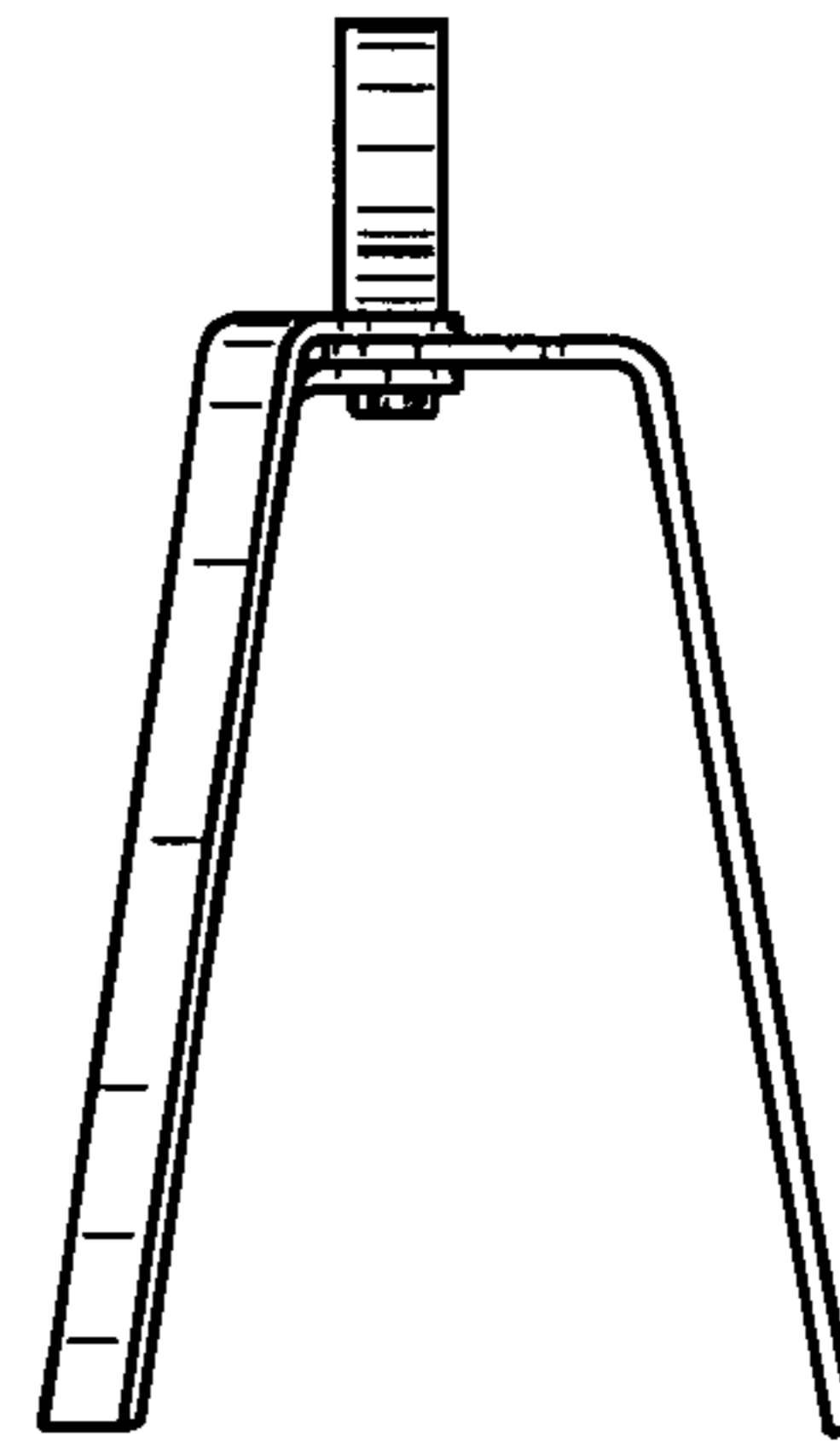

FIG. 11

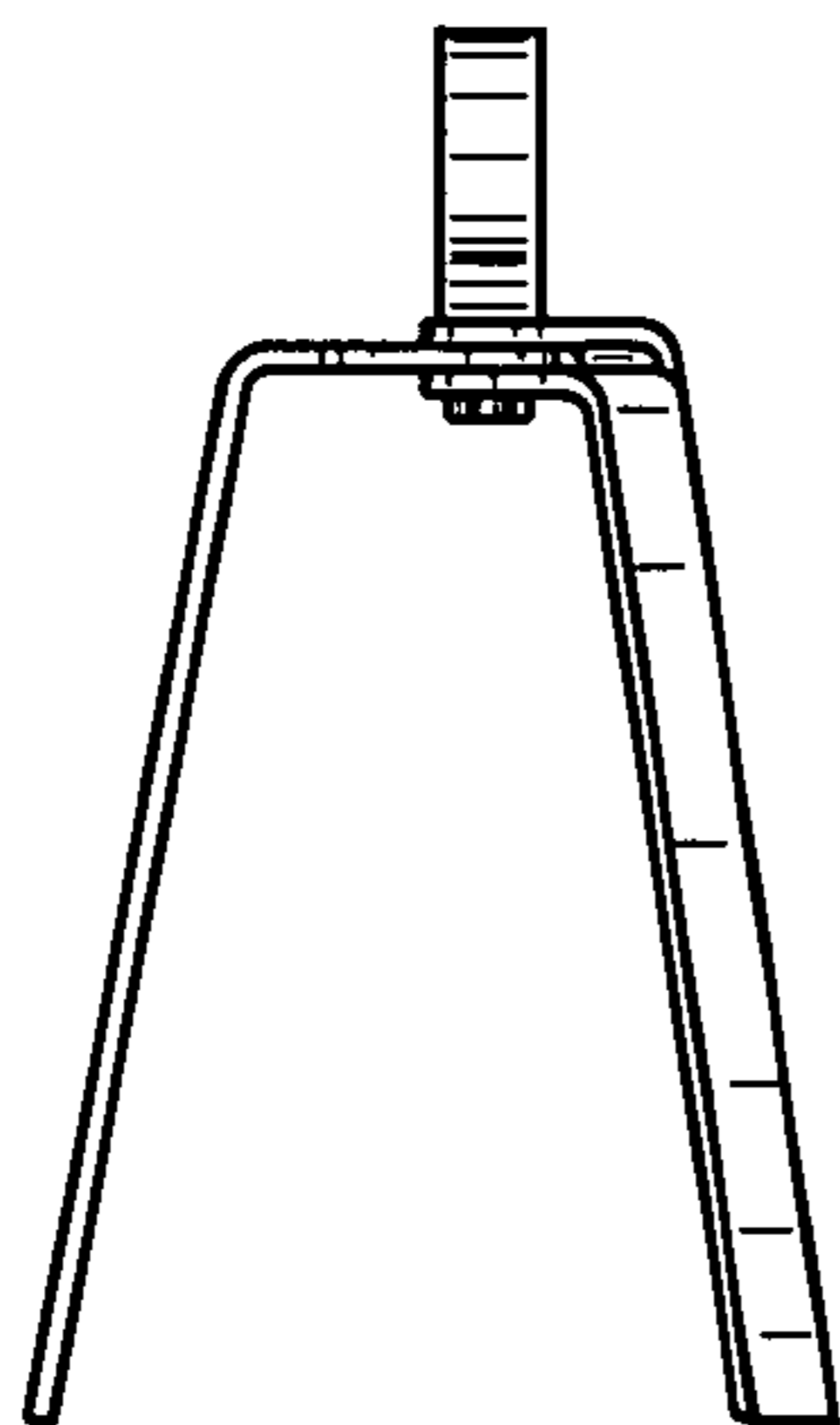

FIG. 12

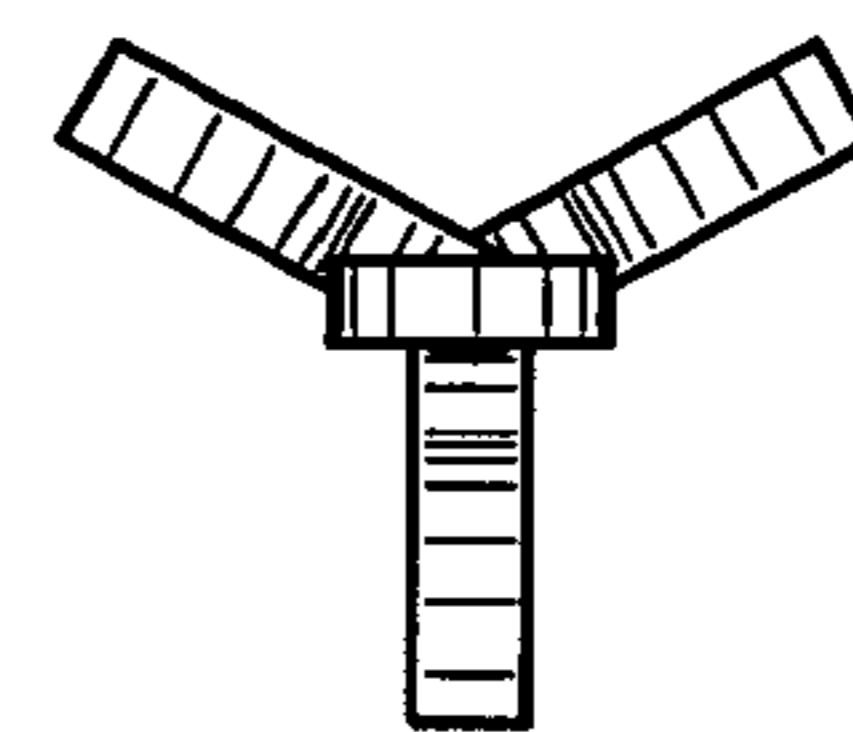

FIG. 13

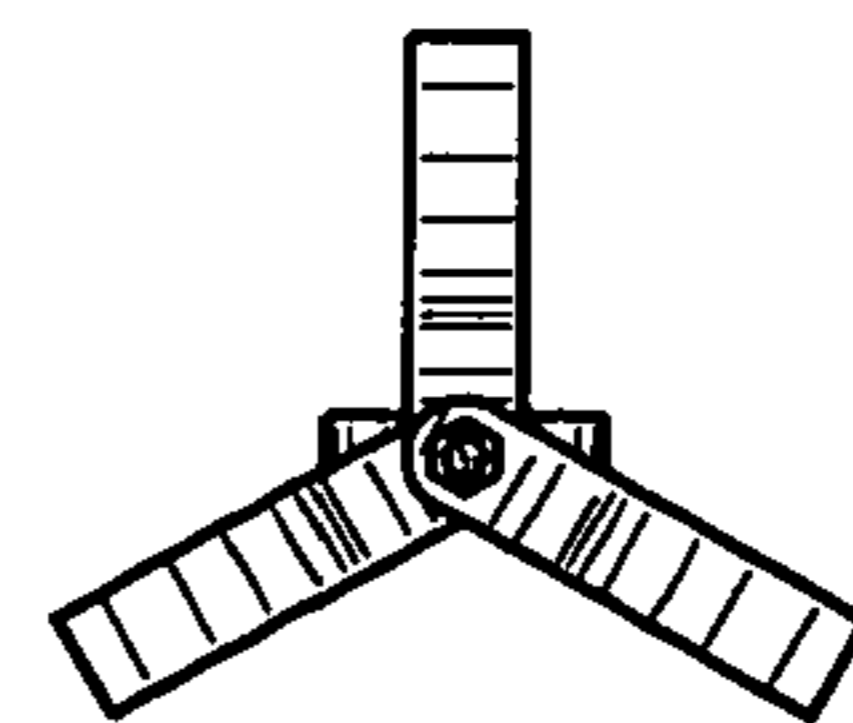

FIG. 14