



US00D578275S

(12) **United States Design Patent**
Shantz et al.

(10) **Patent No.:** **US D578,275 S**
(45) **Date of Patent:** **** Oct. 7, 2008**

(54) **RELIGIOUS ICON**

(76) Inventors: **Martin Howard Shantz**, 3176 Colony La., Plymouth Meeting, PA (US) 19462;
Tyler G. Cox, 98 Browns Rd., Westtown, NY (US) 10998; **Karla Kay Shantz**, 3176 Colony La., Plymouth Meeting, PA (US) 19462

1,526,381 A * 2/1925 Slawson 40/124.5
D67,289 S * 5/1925 Ladewich D99/23
2,036,616 A * 4/1936 Asch 313/312
D365,308 S * 12/1995 White D11/182

* cited by examiner

Primary Examiner—Louis S Zarfaz
Assistant Examiner—Michael A Pratt

(**) Term: **14 Years**

(21) Appl. No.: **29/285,556**

(22) Filed: **Apr. 2, 2007**

(51) **LOC (8) Cl.** **99-00**

(52) **U.S. Cl.** **D99/17**

(58) **Field of Classification Search** D11/95,
D11/96, 97; D99/8, 17, 18, 19, 20, 21, 22,
D99/23, 25, 26, 27

See application file for complete search history.

(56) **References Cited**

U.S. PATENT DOCUMENTS

D43,511 S * 2/1913 Steiner D99/22

(57) **CLAIM**

The ornamental design for the religious icon, as shown.

DESCRIPTION

FIG. 1 is a front elevation view of a first embodiment of the illuminated religious icon showing our new design;

FIG. 2 is perspective thereof;

FIG. 3 is a left side elevation view thereof;

FIG. 4 is a rear elevation view thereof;

FIG. 5 is top plan view thereof; and,

FIG. 6 is a bottom plan view thereof.

1 Claim, 2 Drawing Sheets

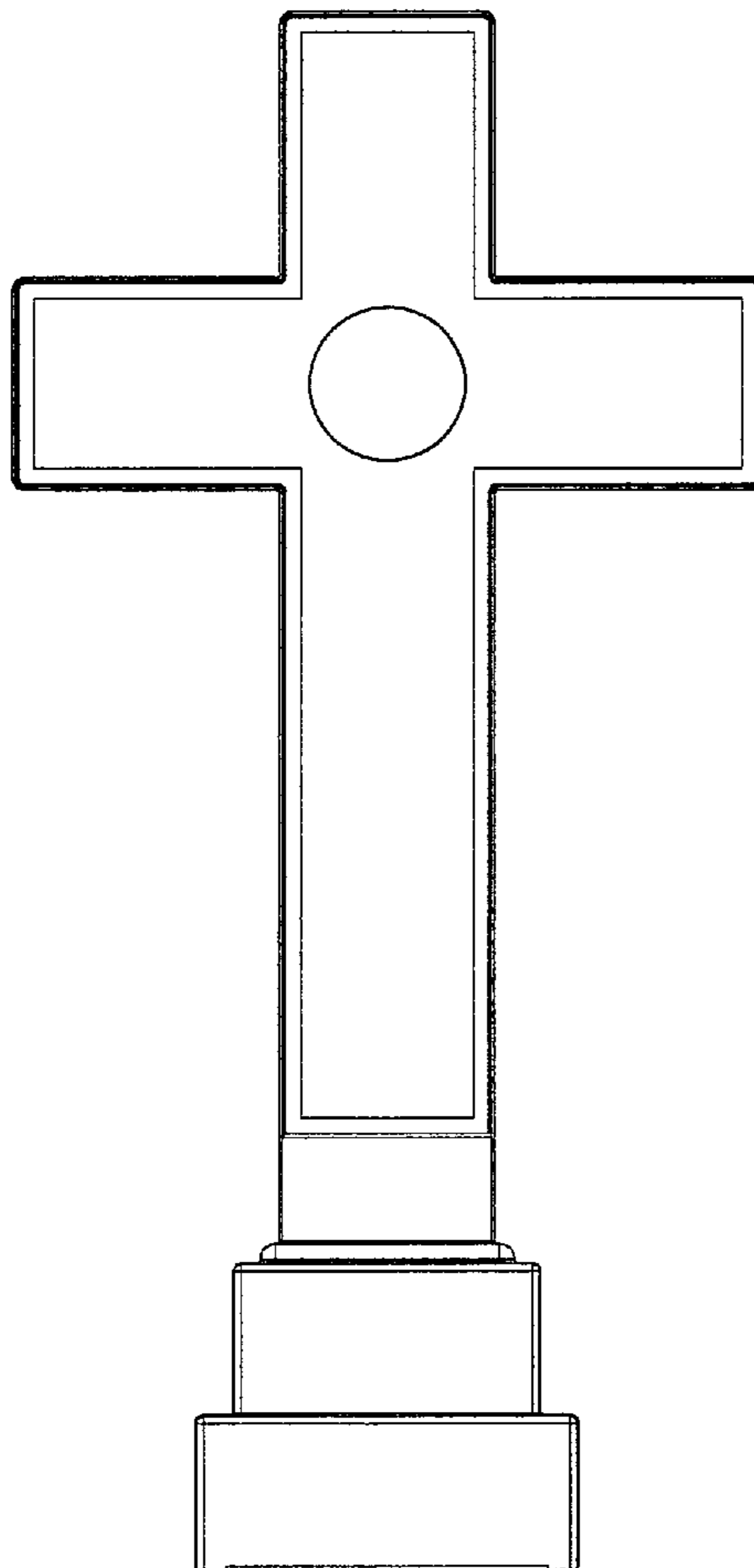

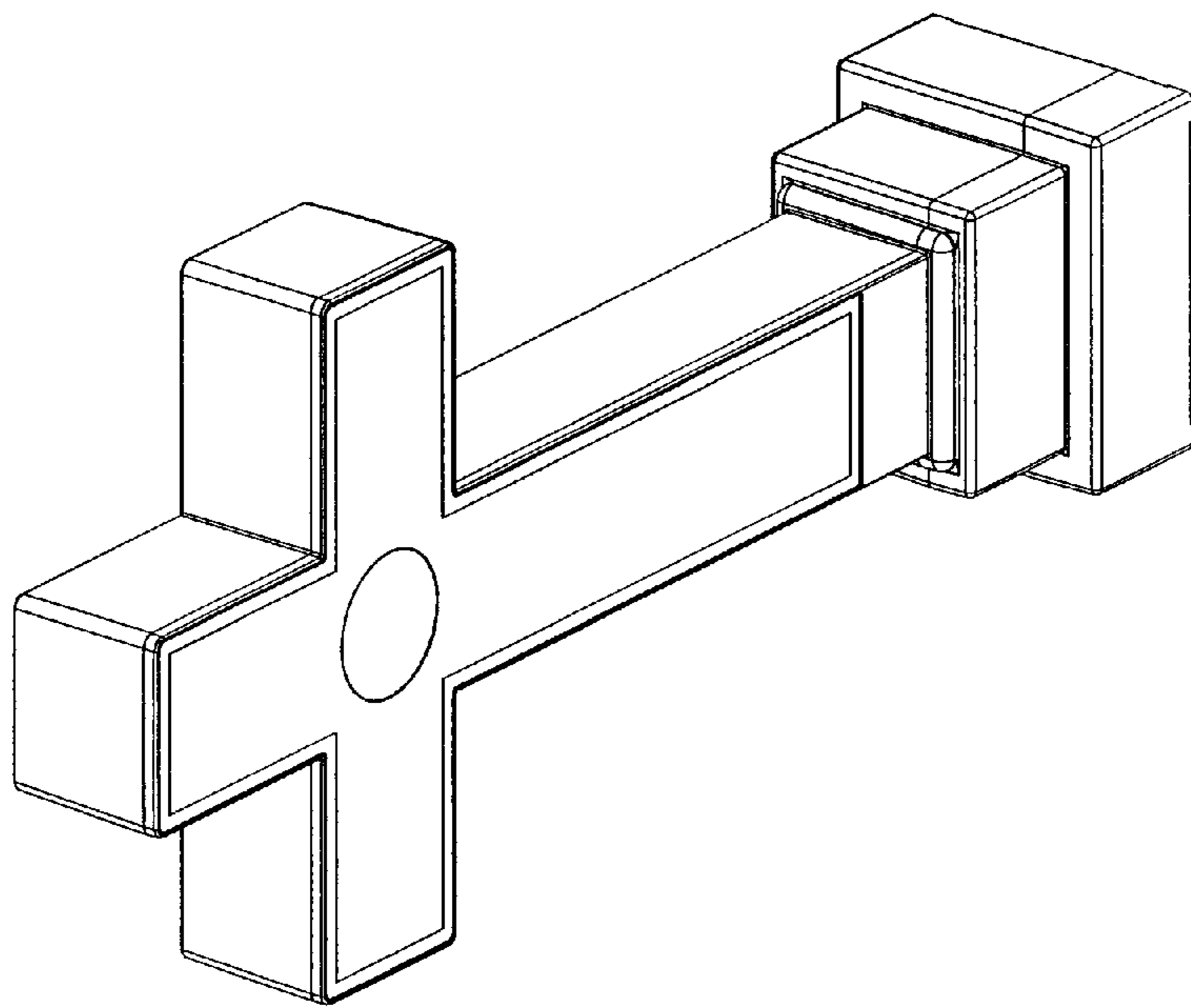

FIGURE 2

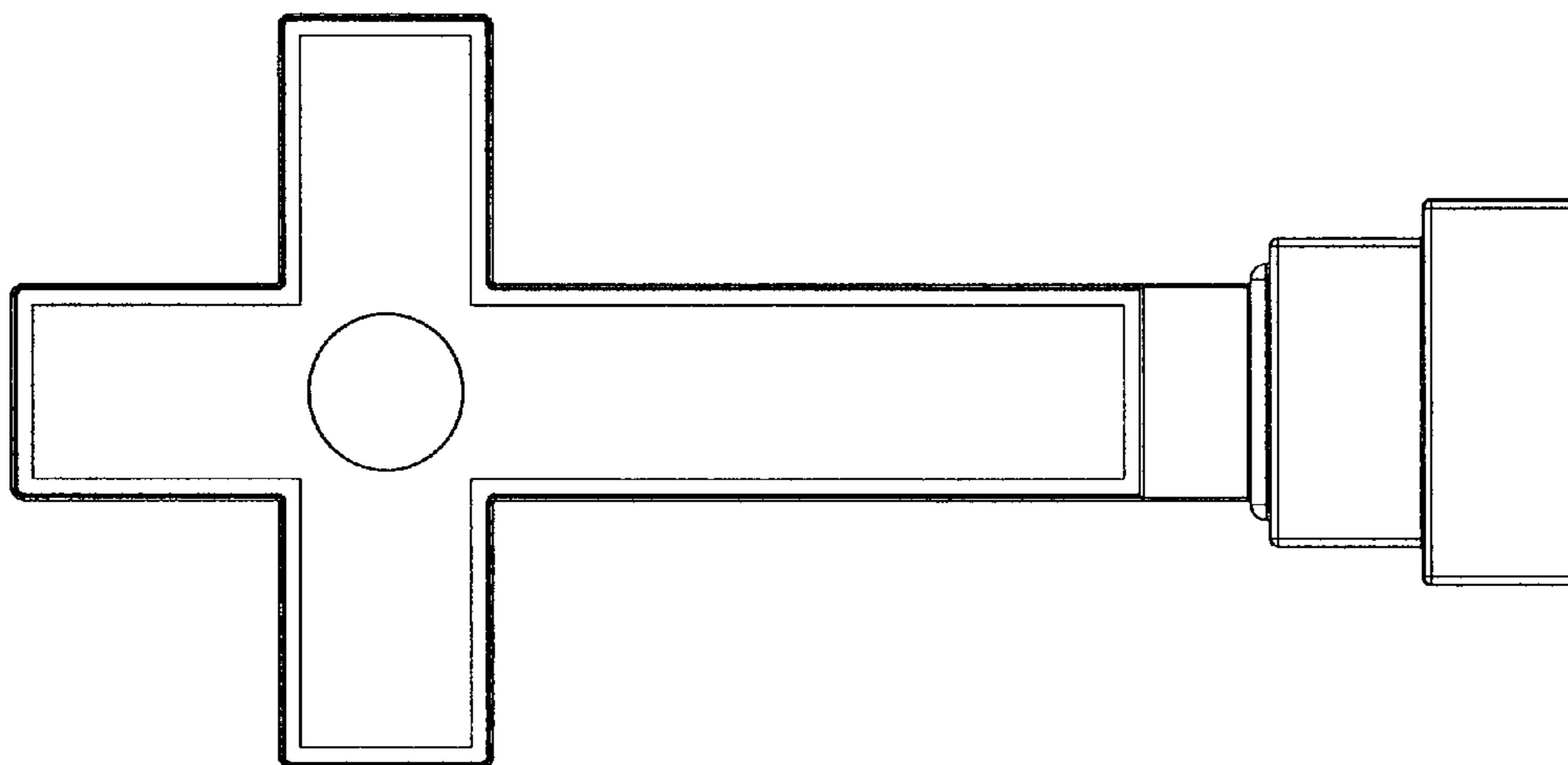

FIGURE 1

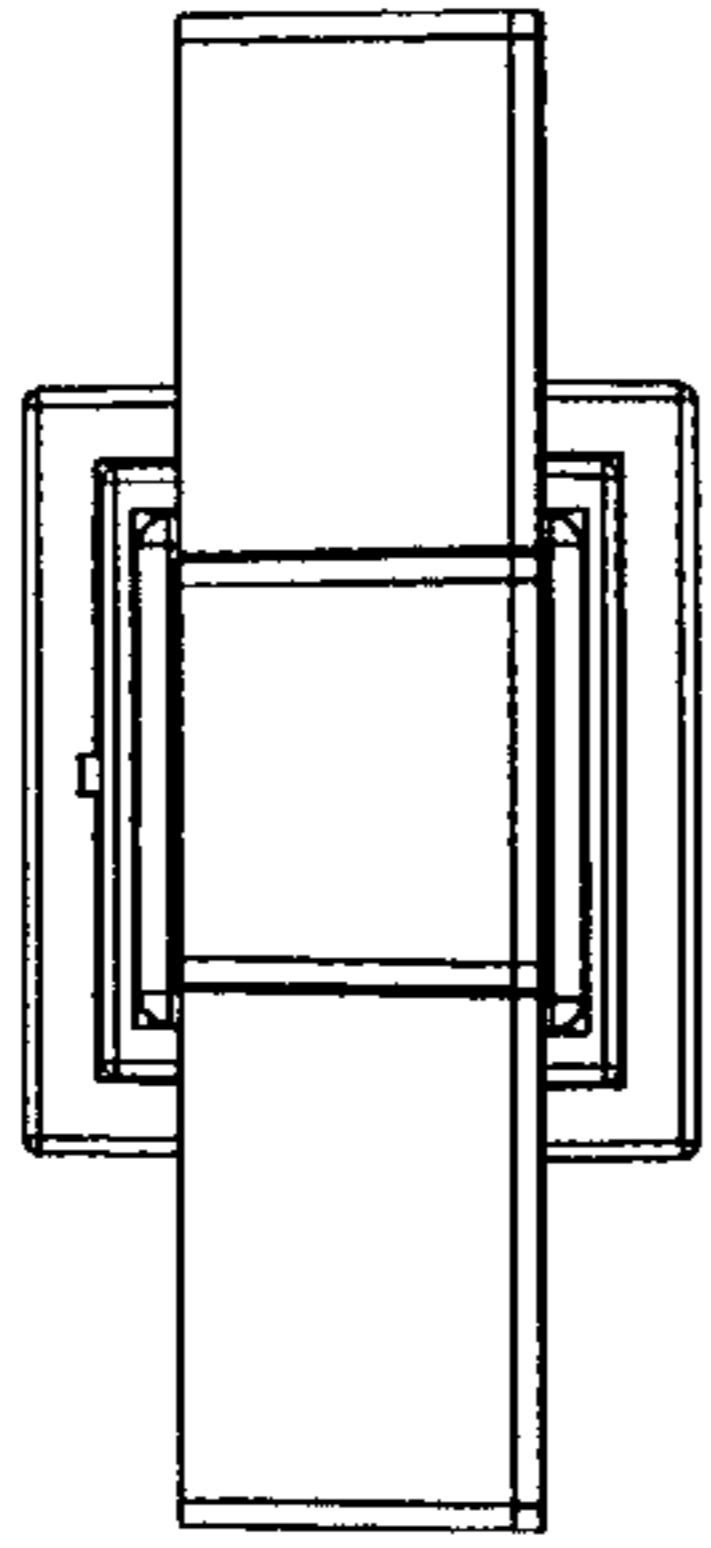

FIGURE 5

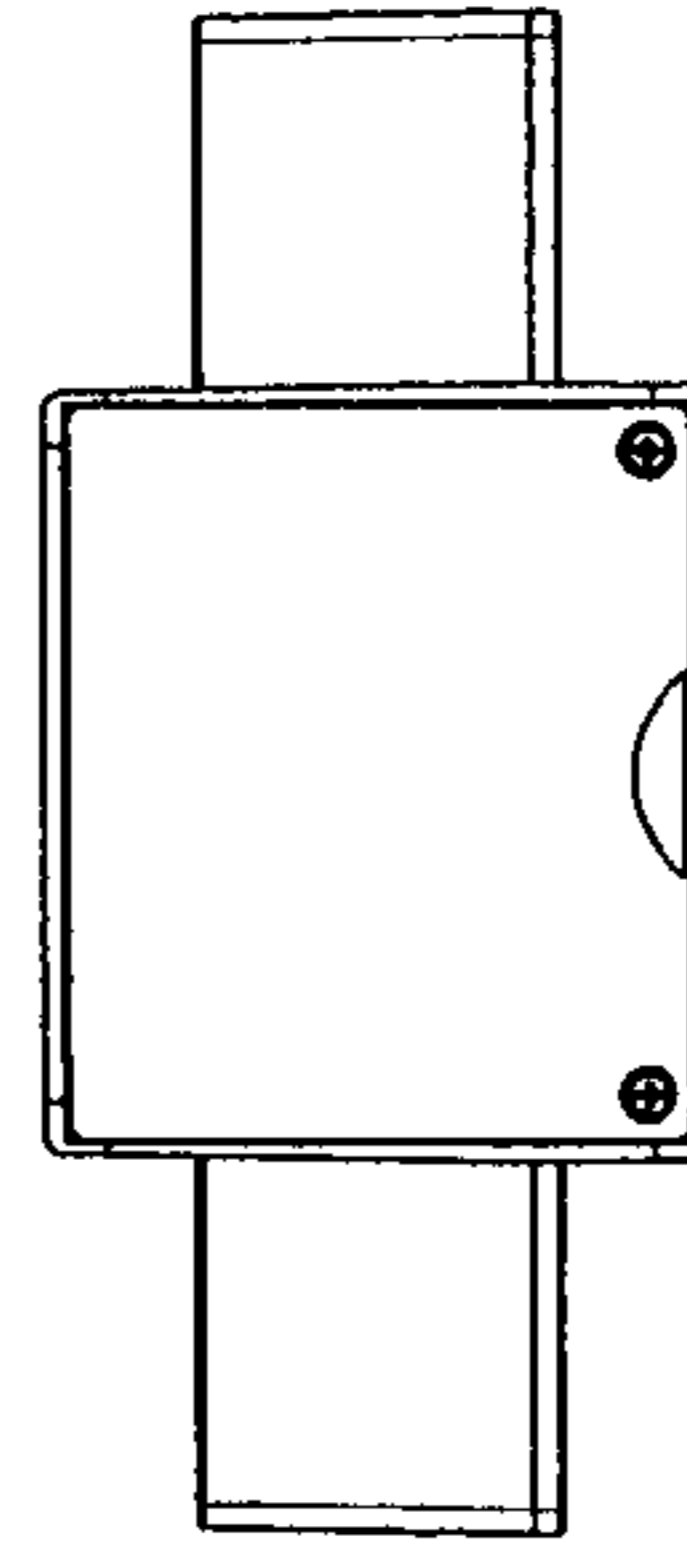

FIGURE 6

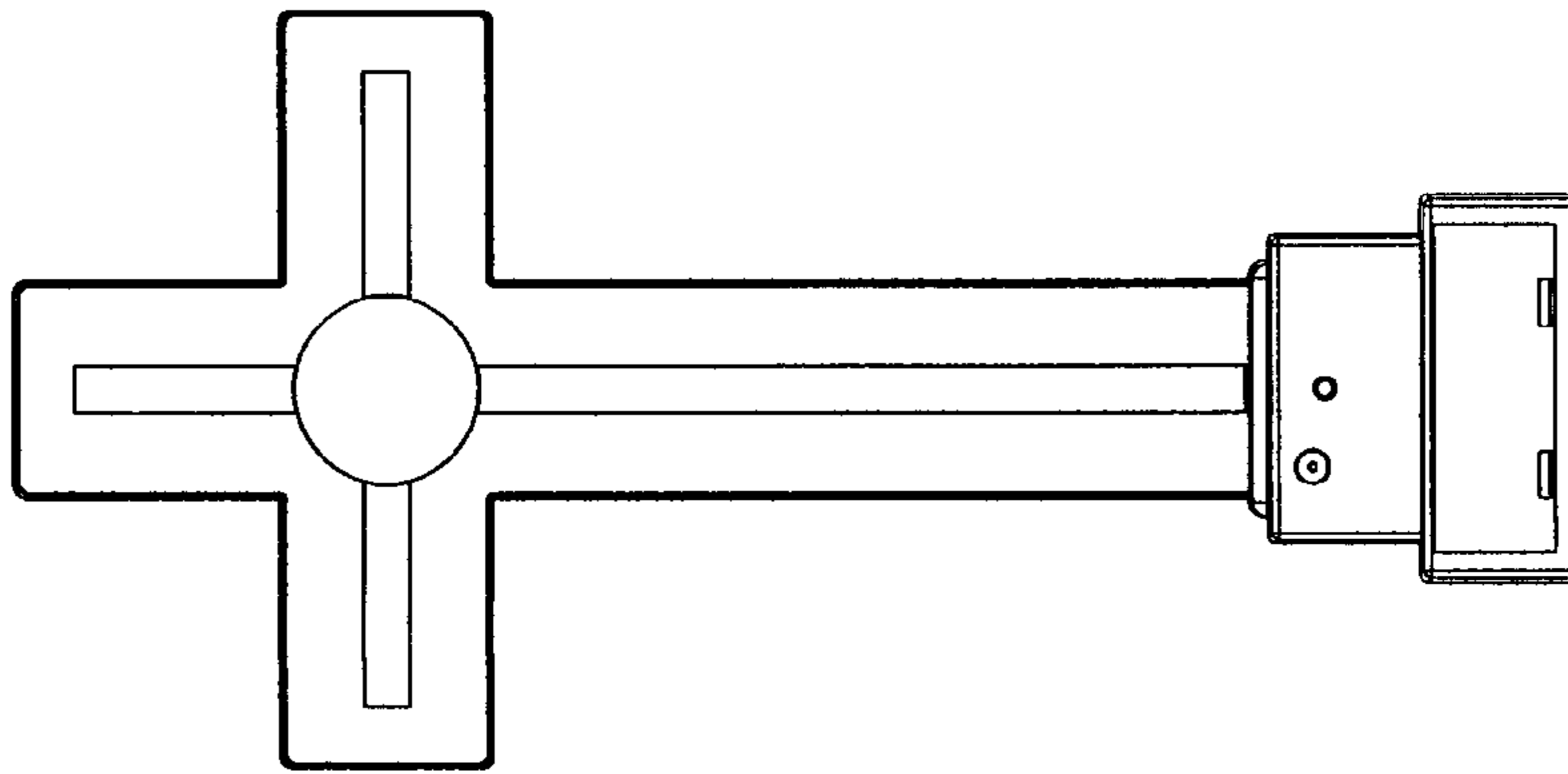

FIGURE 4

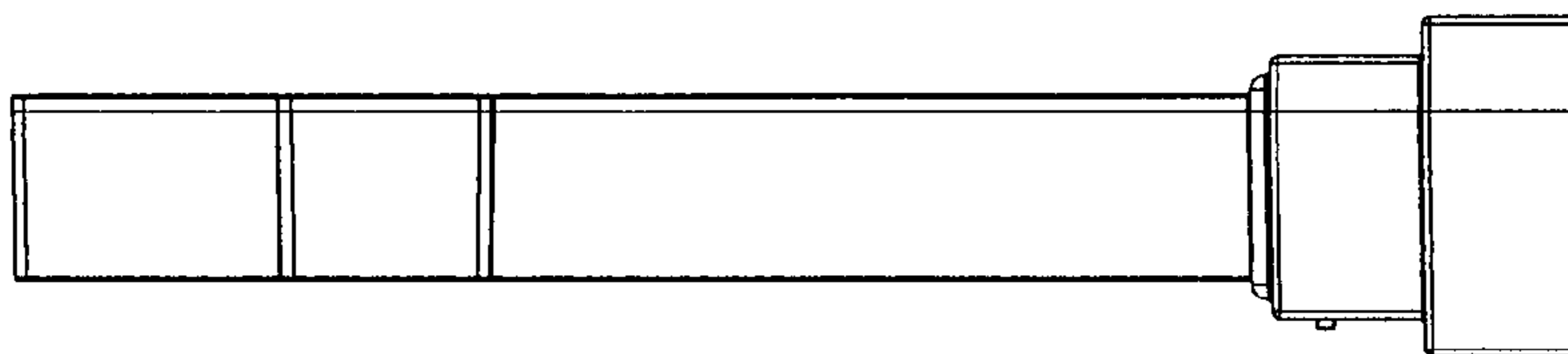

FIGURE 3