



US00D578265S

(12) **United States Design Patent**
Presnell

(10) **Patent No.:** **US D578,265 S**

(45) **Date of Patent:** **** Oct. 7, 2008**

(54) **CONTAINER**

D569,569 S * 5/2008 Dukes D34/10

(75) Inventor: **Donald C. Presnell**, Stephens City, VA
(US)

* cited by examiner

Primary Examiner—Cynthia E Ramirez

(73) Assignee: **Rubbermaid Commercial Products**
LLC, Winchester, VA (US)

(74) *Attorney, Agent, or Firm*—Foley & Lardner, LLP

(**) Term: **14 Years**

(57) **CLAIM**

(21) Appl. No.: **29/295,489**

I claim the ornamental design for a container, as shown and described.

(22) Filed: **Sep. 28, 2007**

DESCRIPTION

(51) **LOC (8) Cl.** **09-09**

FIG. 1 is a top frontal perspective view of a container according to my new design;

(52) **U.S. Cl.** **D34/1**

FIG. 2 is a left side view of the container shown in FIG. 1;

(58) **Field of Classification Search** D34/1-11;
220/908-913

FIG. 3 is a right side view of the container shown in FIG. 1;

See application file for complete search history.

FIG. 4 is a front view of the container shown in FIG. 1;

FIG. 5 is a back view of the container shown in FIG. 1;

(56) **References Cited**

U.S. PATENT DOCUMENTS

4,576,310	A *	3/1986	Isgar et al.	220/495.1
4,923,087	A *	5/1990	Burrows	220/495.1
D333,196	S *	2/1993	Dziersk et al.	D34/1
D387,530	S *	12/1997	Doxey	D34/1
D521,203	S *	5/2006	Sofy et al.	D34/1
D555,317	S *	11/2007	Yang et al.	D34/1
D566,365	S *	4/2008	Wentz et al.	D34/1

FIG. 6 is a top view of the container shown in FIG. 1; and,

FIG. 7 is a bottom view of the container shown in FIG. 1.

The ornamental design which is claimed is shown in solid lines in the drawings. The broken lines in the drawings are for illustrative purposes only and form no part of the claimed design.

1 Claim, 4 Drawing Sheets

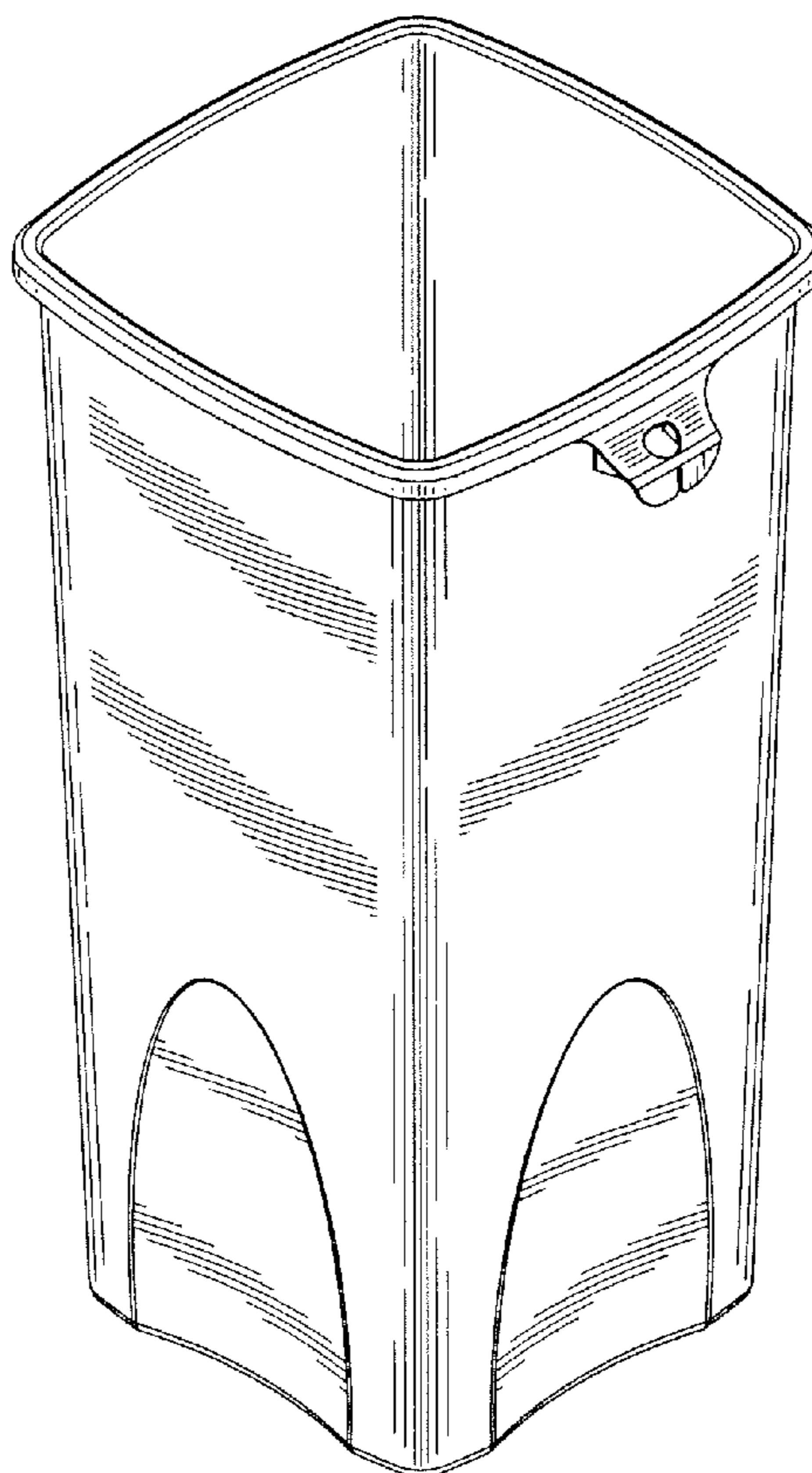

Fig. 1

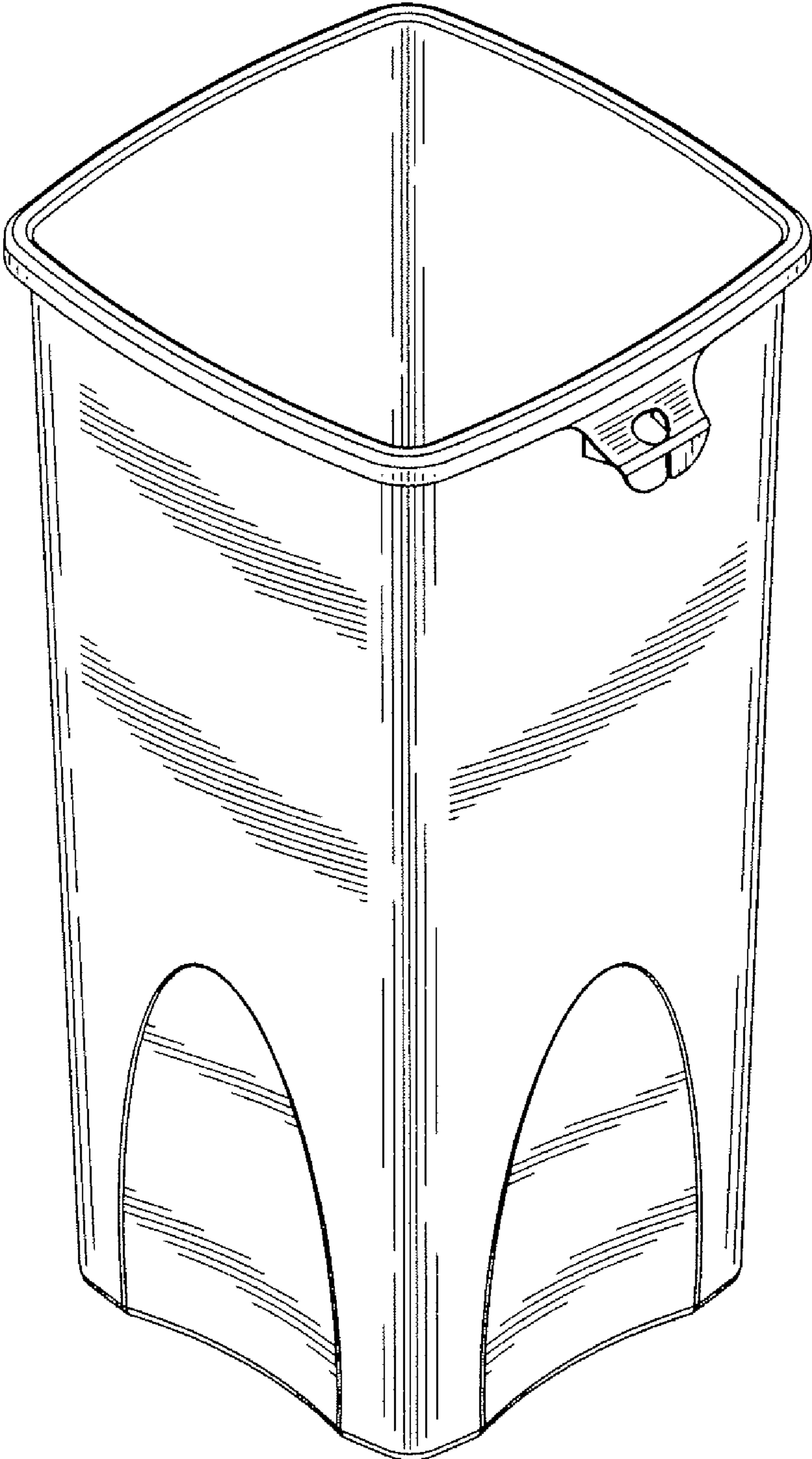

Fig. 2

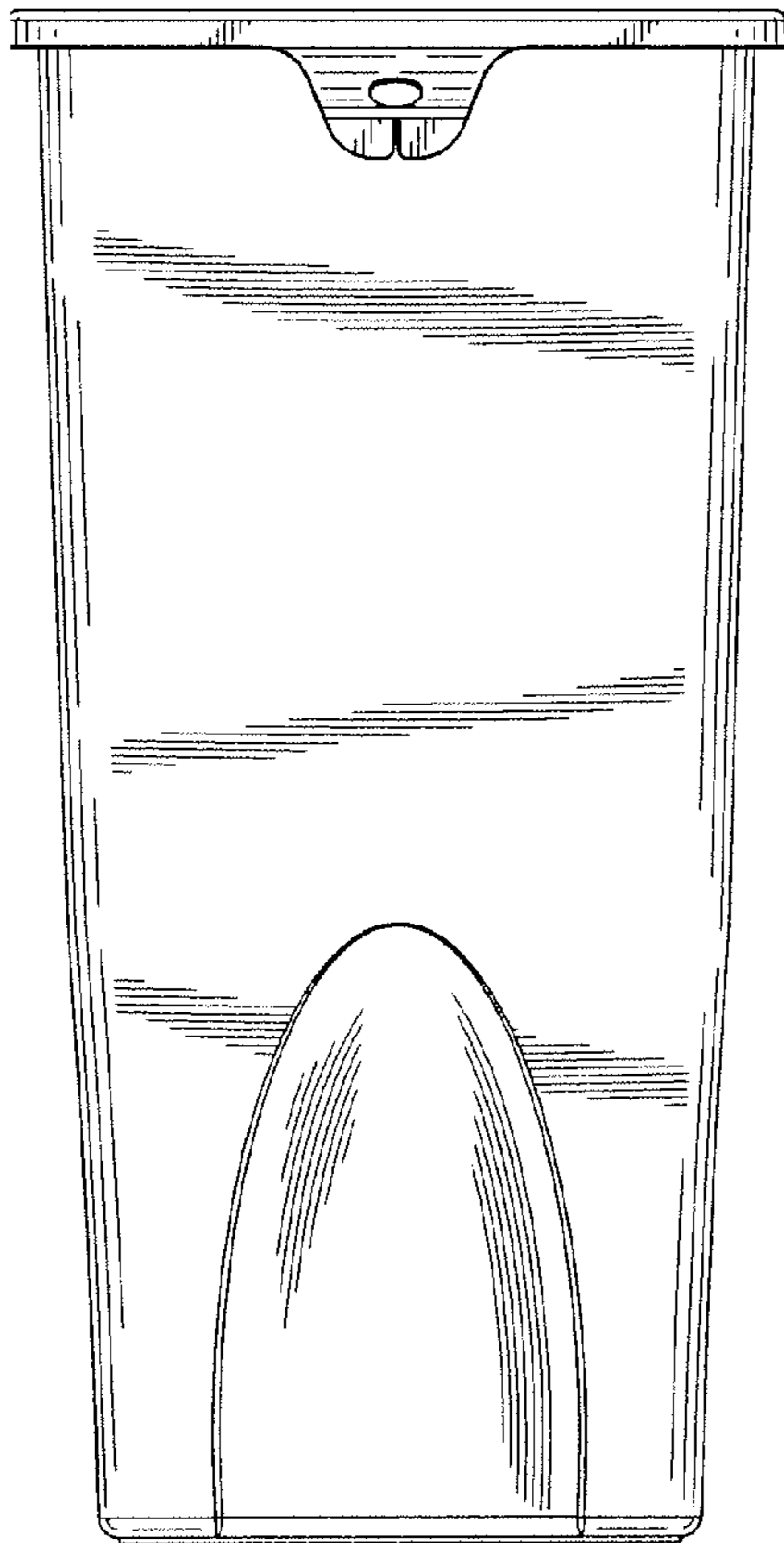

Fig. 3

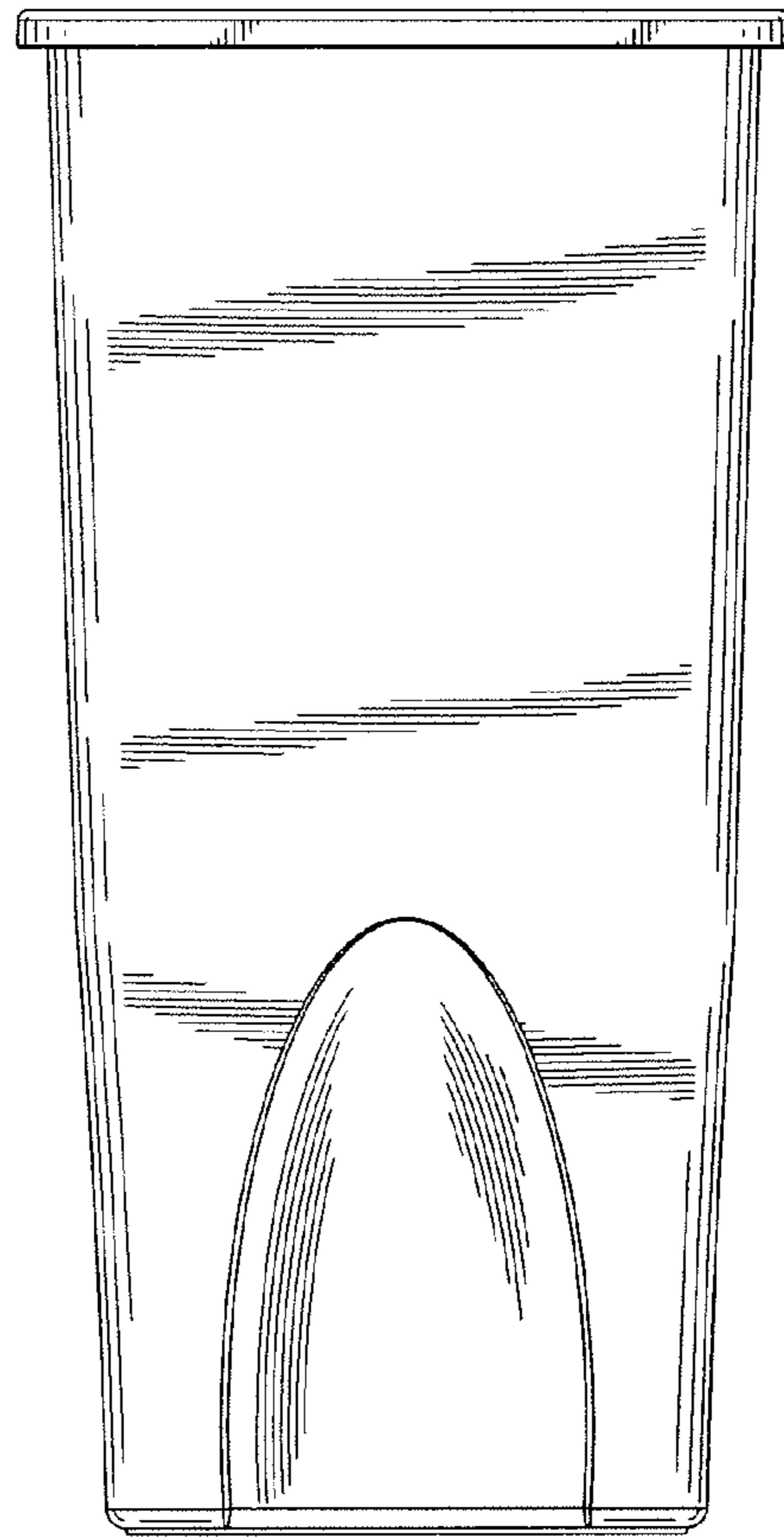

Fig. 4

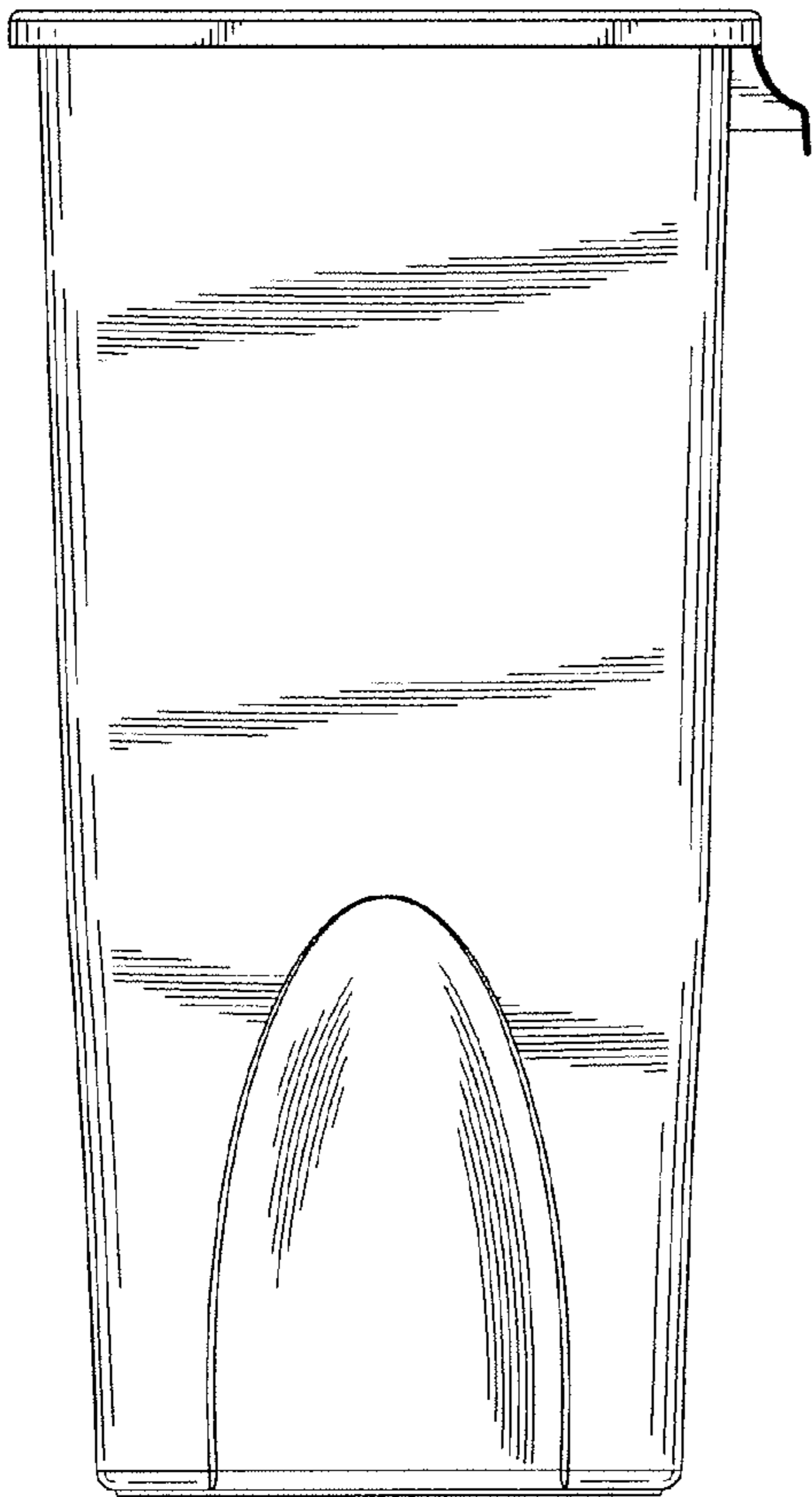

Fig. 5

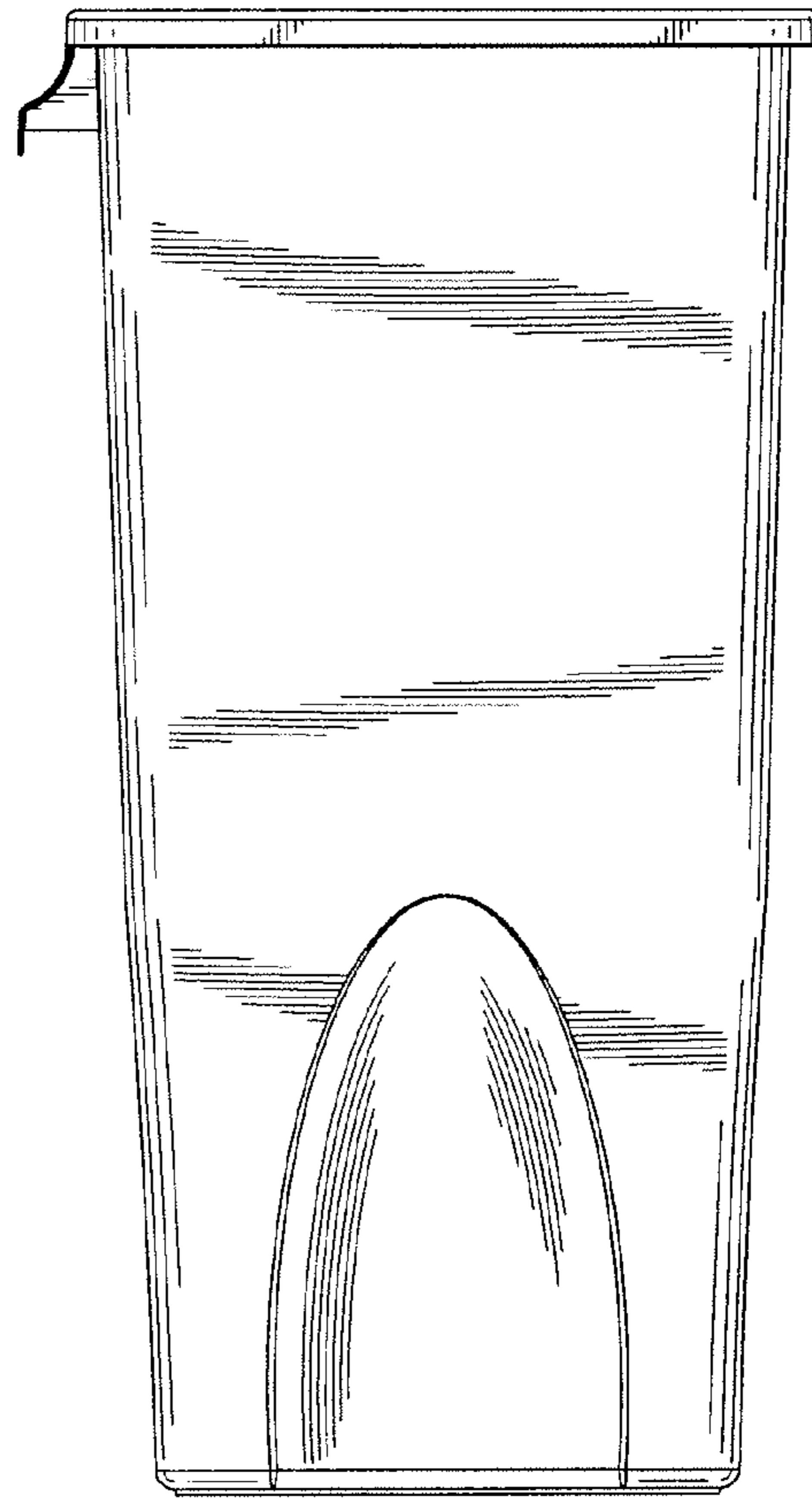

Fig. 6

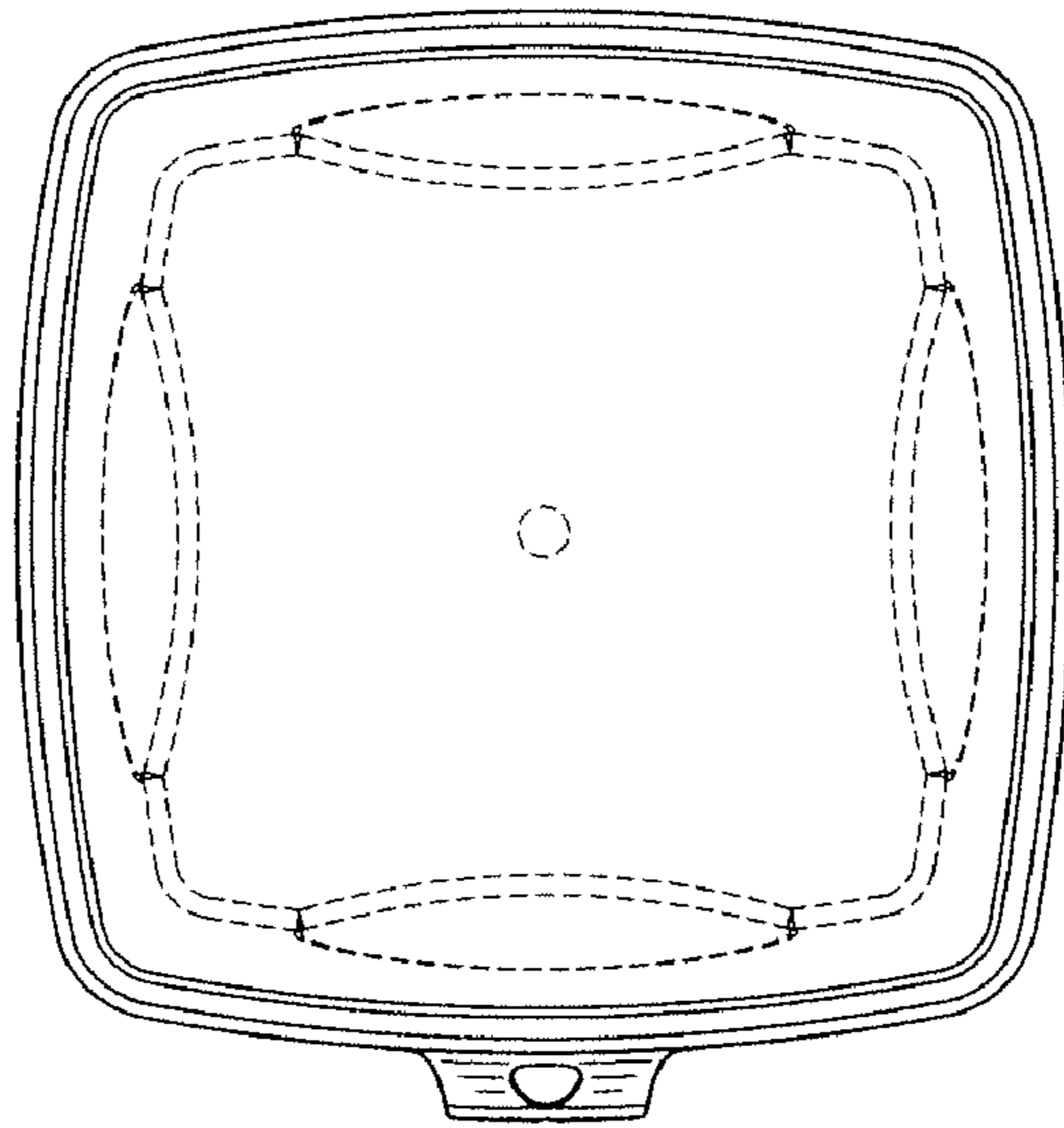

Fig. 7

