



US00D578252S

(12) **United States Design Patent**
Kubono et al.

(10) **Patent No.:** **US D578,252 S**
(45) **Date of Patent:** **** Oct. 7, 2008**

(54) **ELECTRIC DEPILATOR**

(75) Inventors: **Kazuma Kubono**, Ageo (JP); **Keiko Ohta**, Ichikawa (JP)

(73) Assignee: **Matsushita Electric Works, Ltd.**, Osaka (JP)

(**) Term: **14 Years**

(21) Appl. No.: **29/294,131**

(22) Filed: **Dec. 21, 2007**

(30) **Foreign Application Priority Data**

Jun. 28, 2007 (JP) 2007-017329

(51) **LOC (8) Cl.** **28-03**

(52) **U.S. Cl.** **D28/44.1; D28/50**

(58) **Field of Classification Search** 30/30,
30/32, 34.05, 34.1-34.2, 44-45, 43-43.92,
30/47-51, 57-58, 526-527, 532-533; D28/49-54,
D28/44.1; 606/133; D24/133, 147
See application file for complete search history.

(56) **References Cited**

U.S. PATENT DOCUMENTS

D315,034 S * 2/1991 Platek D28/44.1
D344,157 S * 2/1994 Oord et al. D28/50
D431,679 S * 10/2000 Jacobs D28/44.1
D436,228 S * 1/2001 Sulik et al. D28/50
D469,219 S * 1/2003 McLachlan D28/50

D500,168 S * 12/2004 Ho D28/44

* cited by examiner

Primary Examiner—Jennifer Rivard

(74) *Attorney, Agent, or Firm*—Osha • Liang LLP

(57) **CLAIM**

The ornamental design for an electric depilator, as shown and described.

DESCRIPTION

FIG. 1 is a front, perspective view of the design according to the invention.

FIG. 2 is a rear, perspective view of the design according to the invention.

FIG. 3 is a front view of the design according to the invention.

FIG. 4 is a right side view of the design according to the invention.

A left side view of the design according to the invention is a mirror image of the right side view as shown in FIG. 4.

FIG. 5 is a top view of the design according to the invention.

FIG. 6 is a rear view of the design according to the invention; and,

FIG. 7 is a bottom view of the design according to the invention.

The elements shown in broken lines are for illustrative purposes only and form no art of the claimed invention.

1 Claim, 4 Drawing Sheets

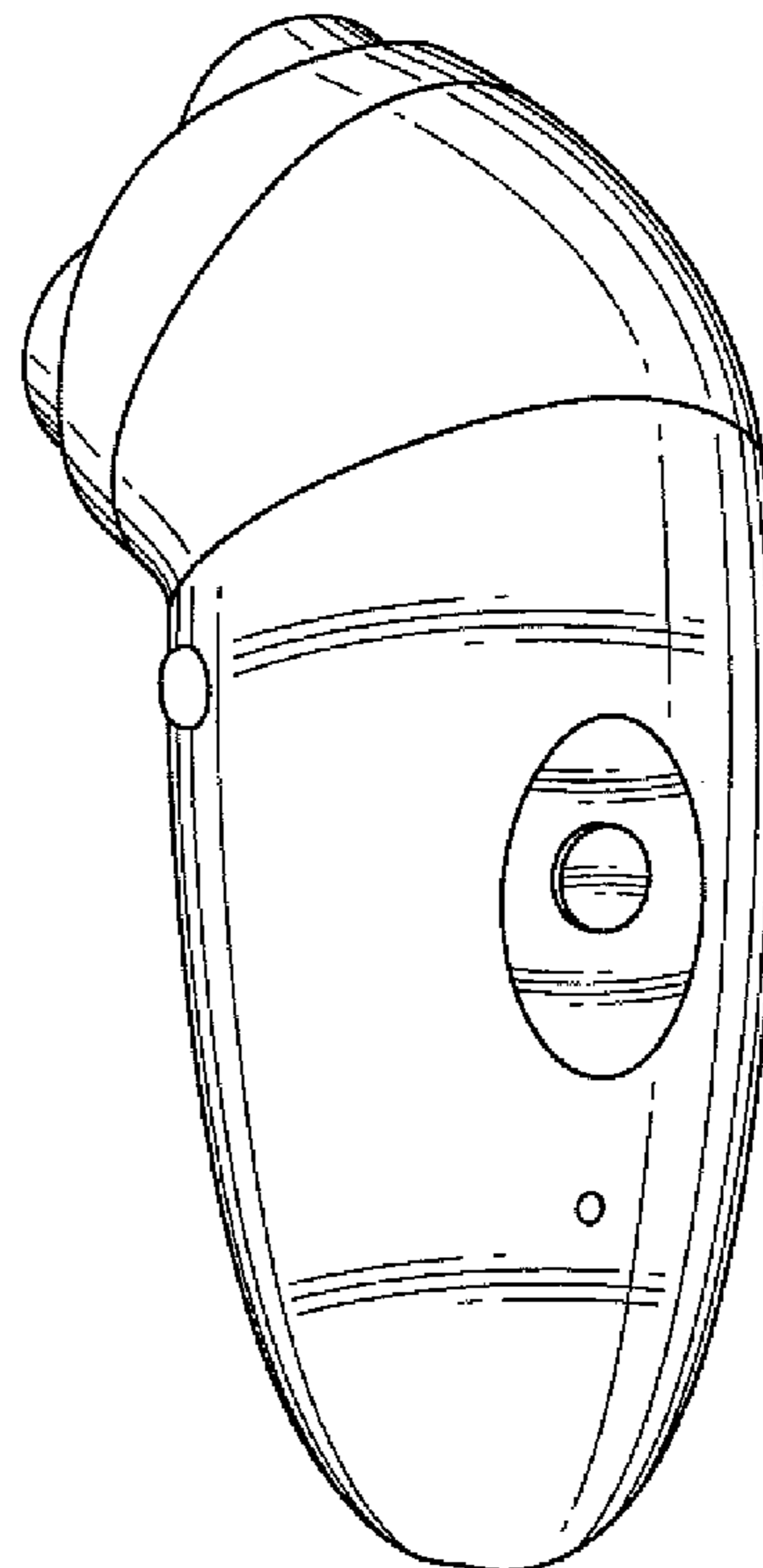
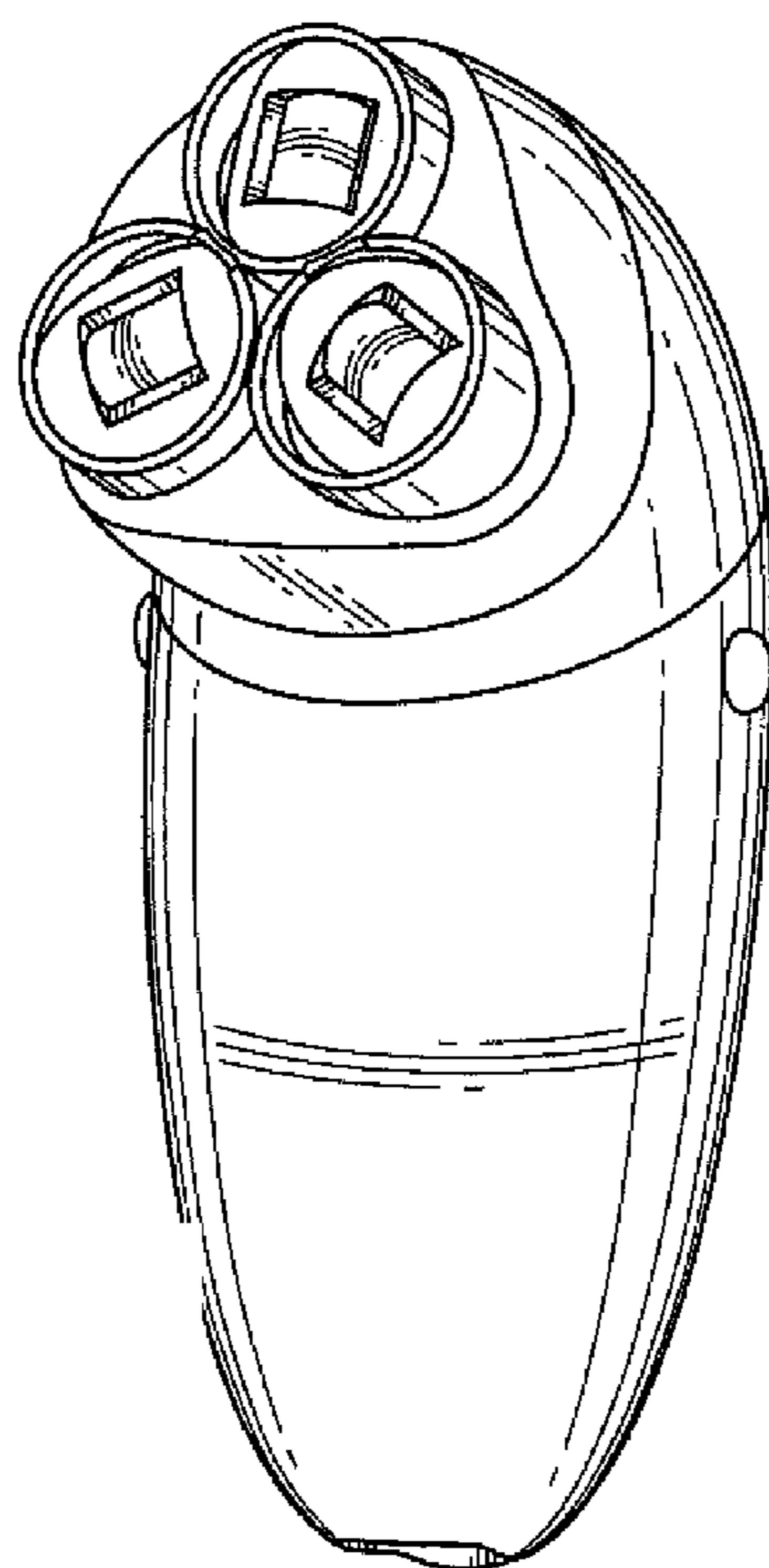

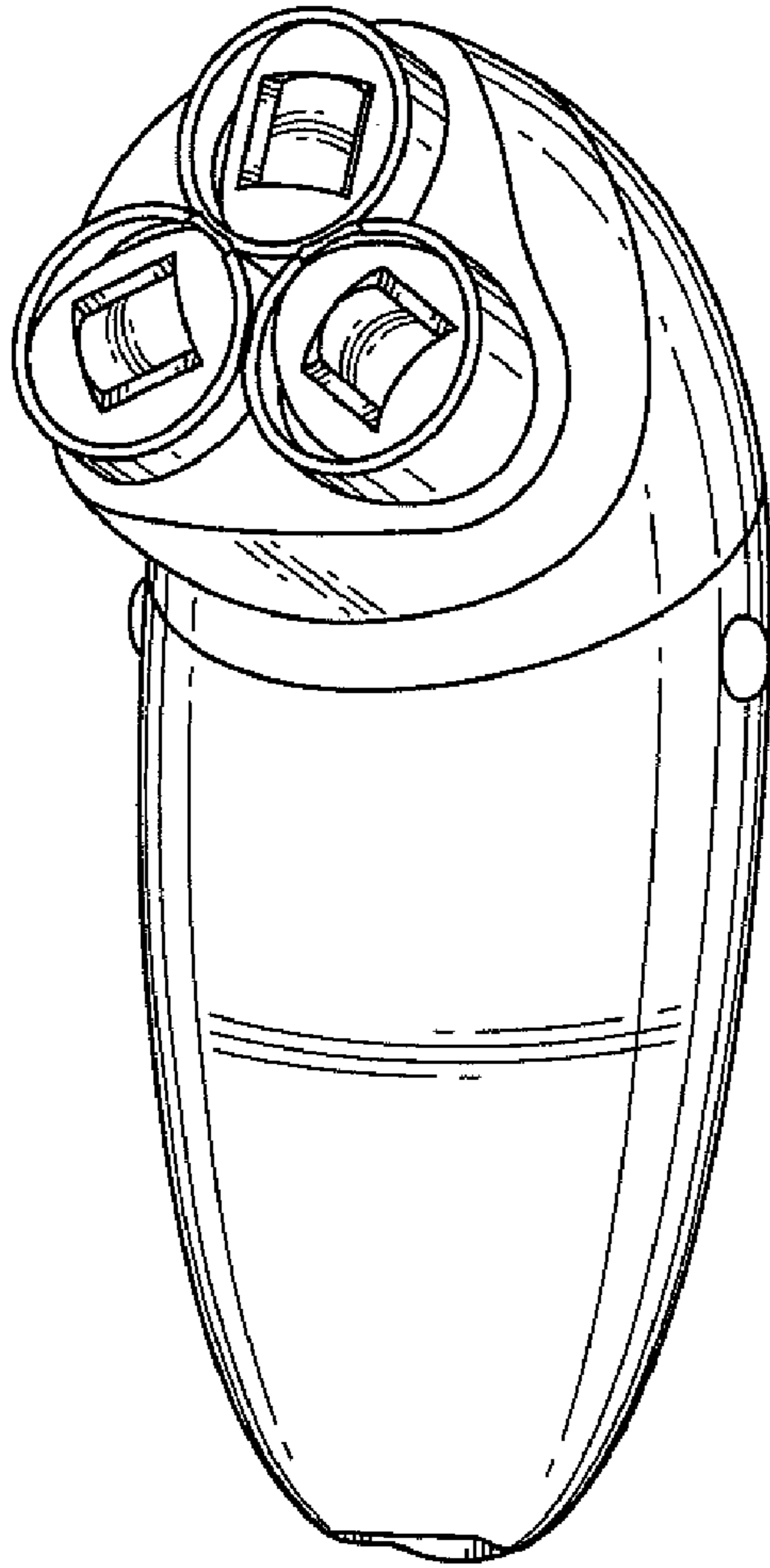

FIG. 1

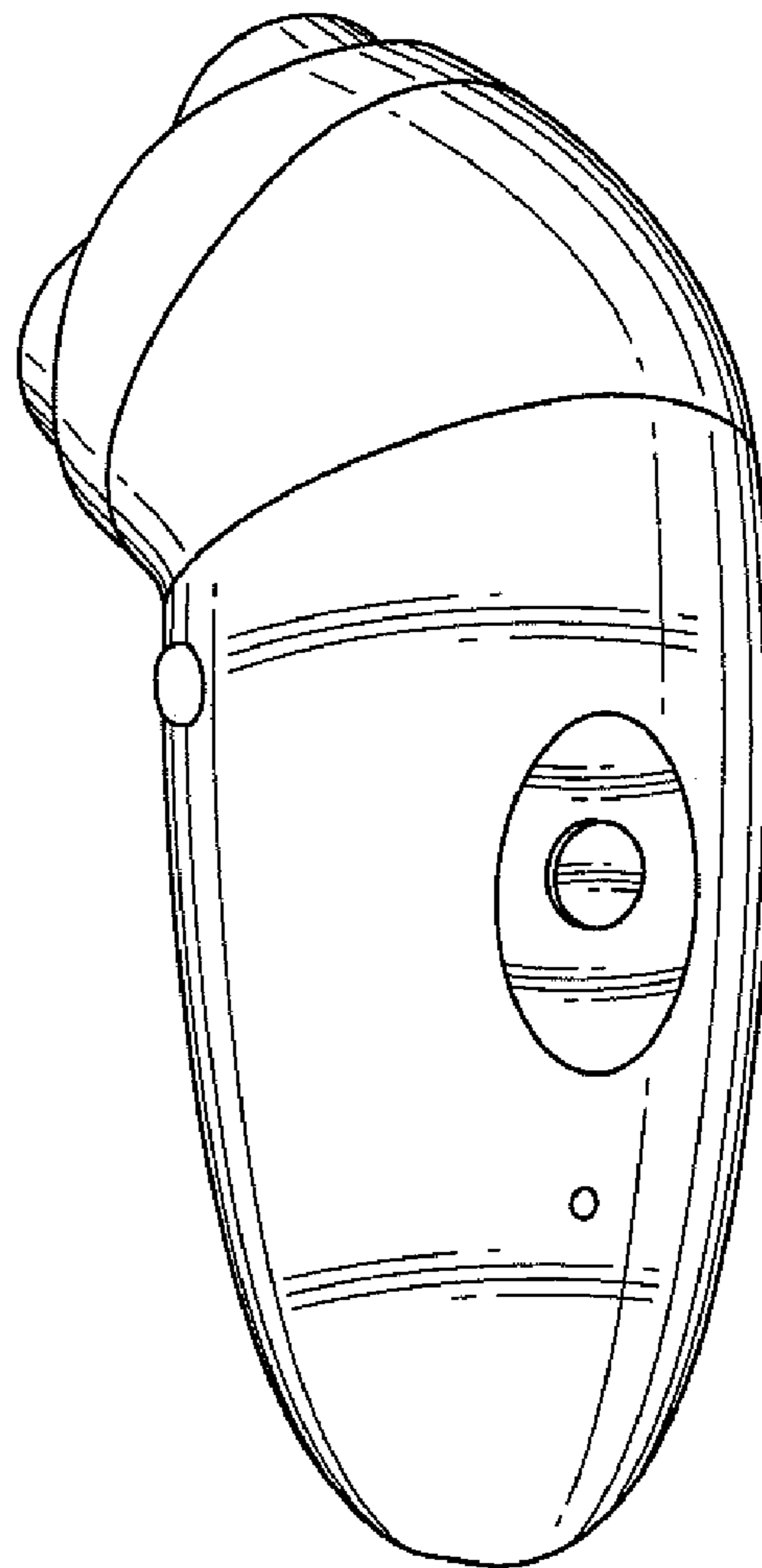

FIG. 2

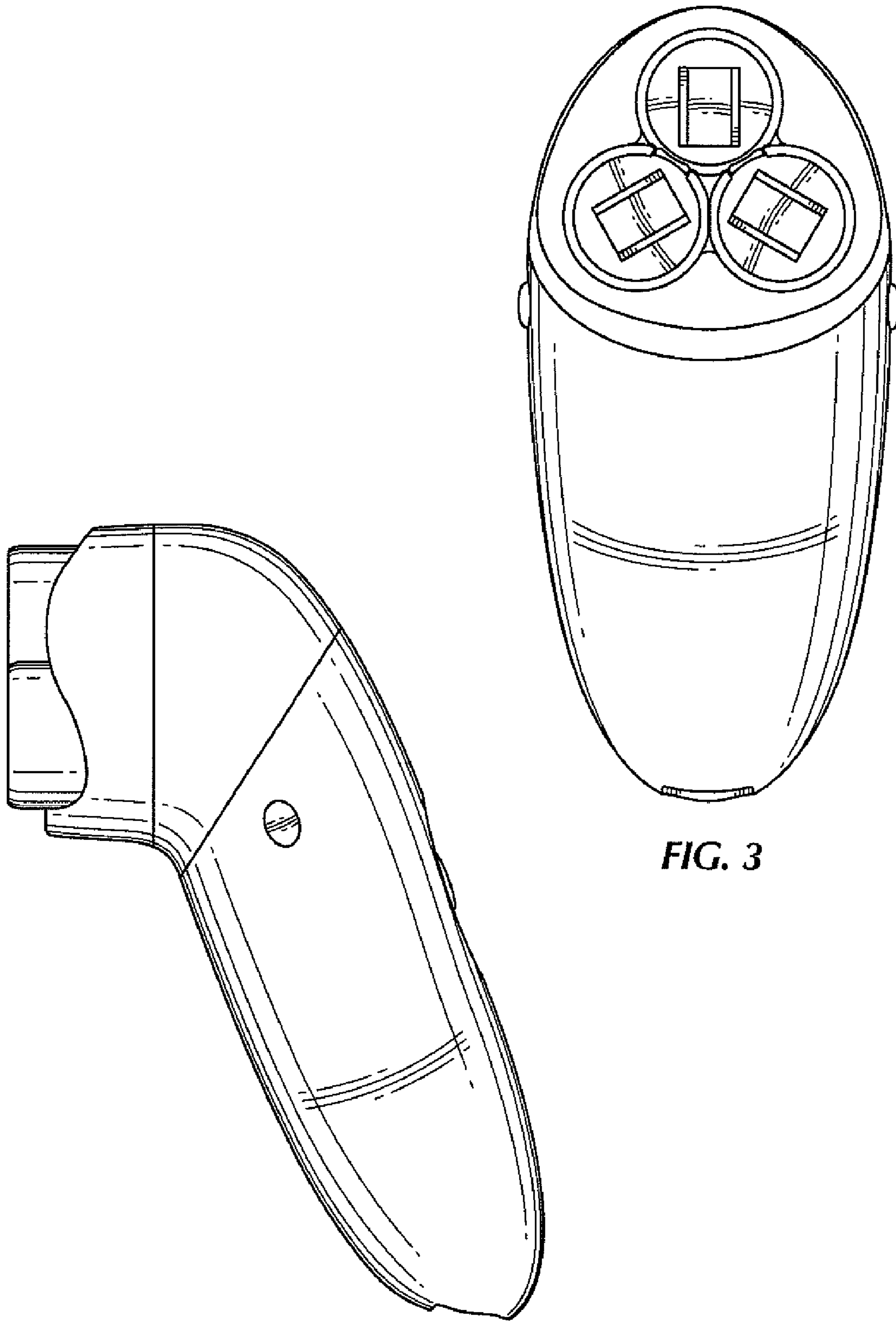

FIG. 3

FIG. 4

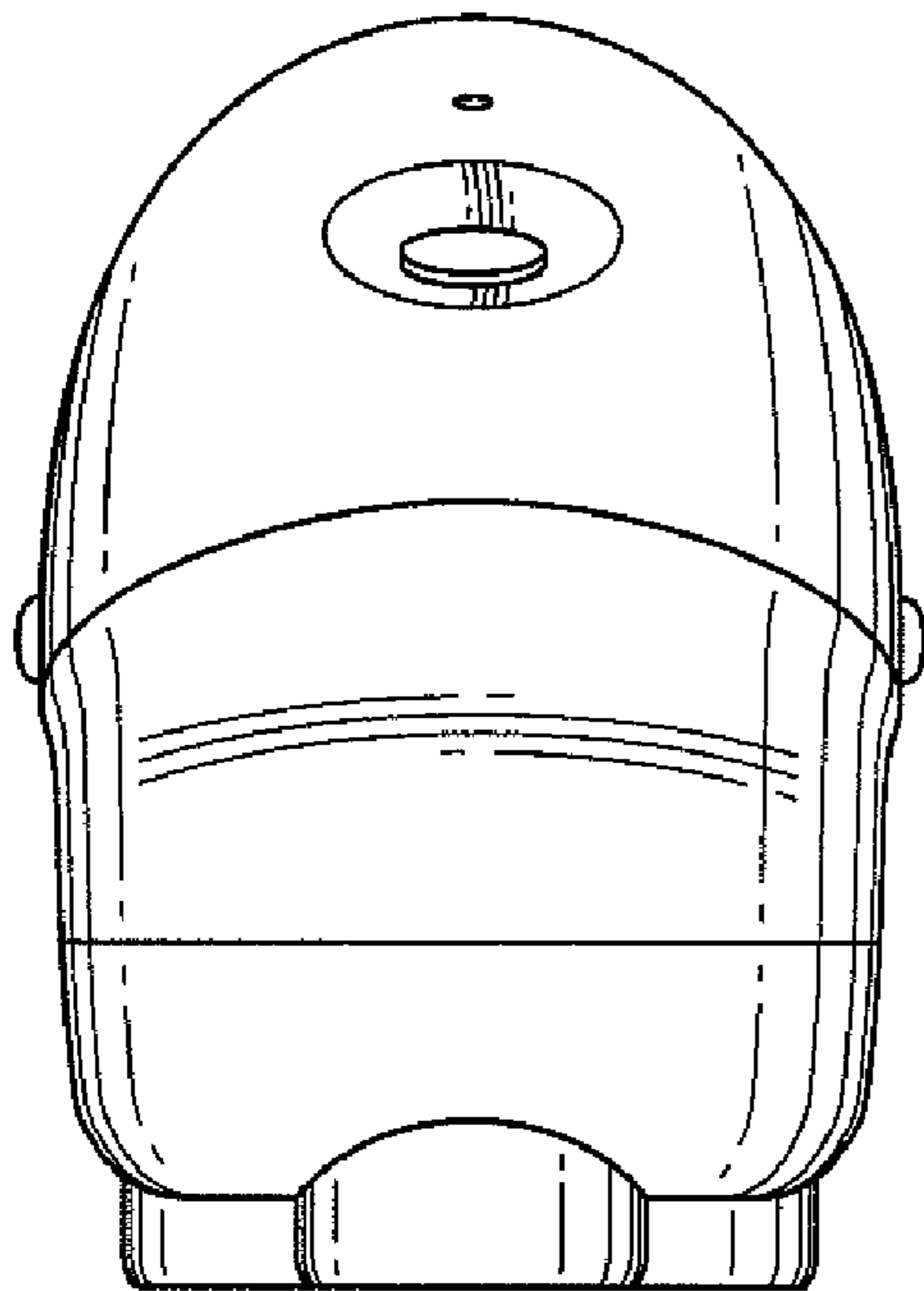

FIG. 5

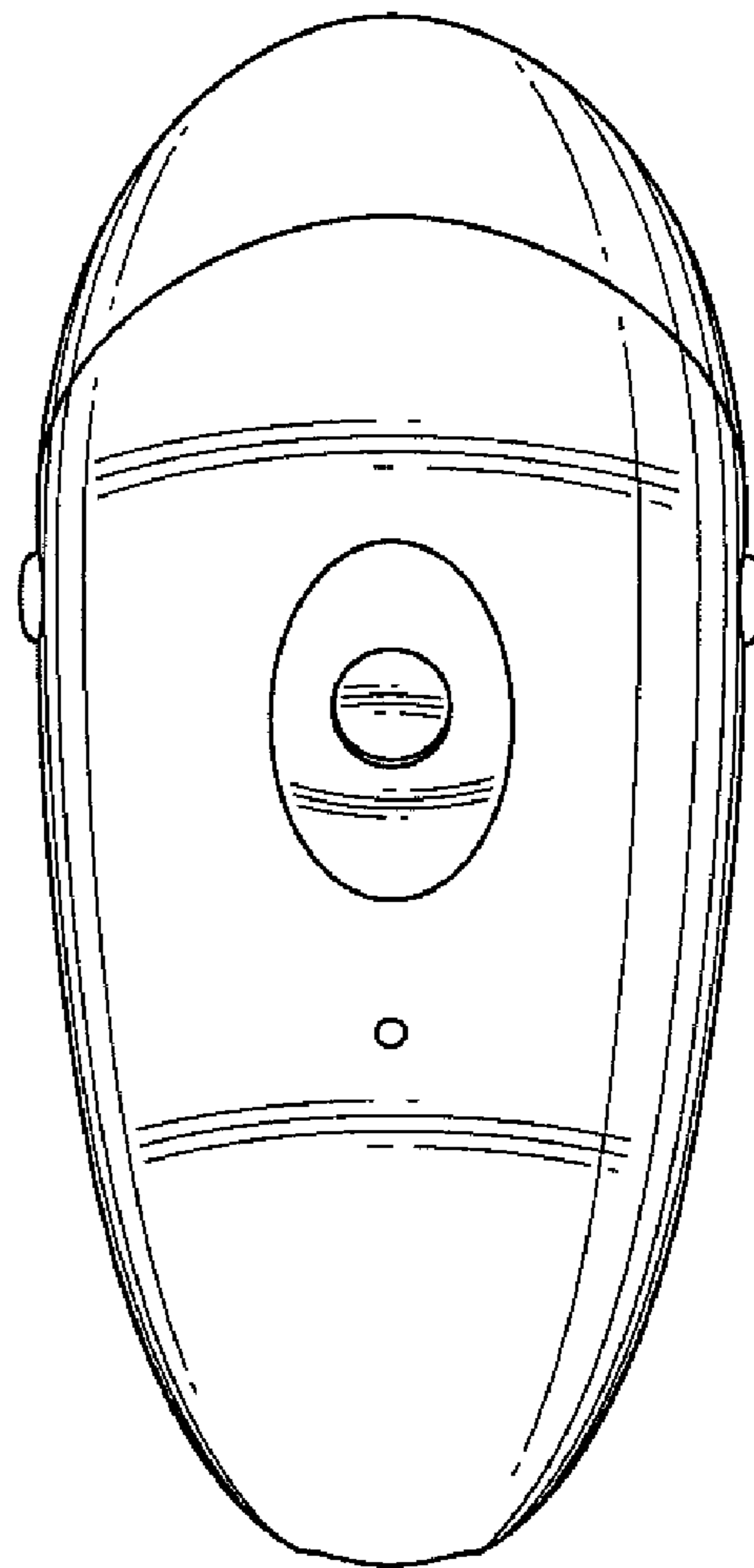

FIG. 6

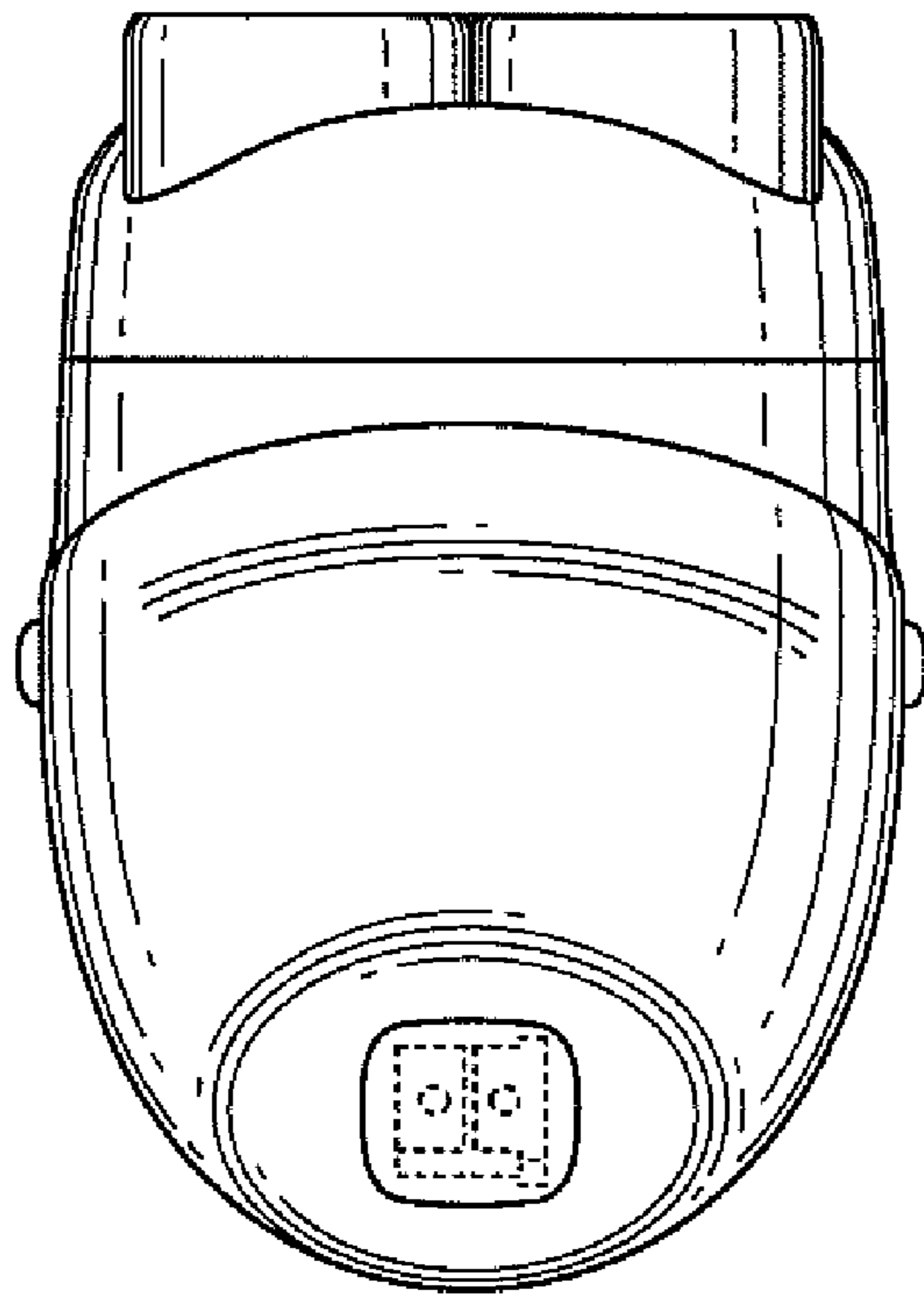

FIG. 7