



US00D578190S

(12) **United States Design Patent**
Gao

(10) **Patent No.:** **US D578,190 S**

(45) **Date of Patent:** **** Oct. 7, 2008**

(54) **HEATER**

D462,753 S * 9/2002 Gao D23/335
D465,835 S * 11/2002 Gao D23/325
D467,324 S * 12/2002 Ching D23/335

(76) Inventor: **Tianyu Gao**, Jinke Bldg. 8, Science &
Technology Park, Nanshan Dist.,
Shenzhen (CN)

* cited by examiner

(**) Term: **14 Years**

Primary Examiner—Robert M. Spear
Assistant Examiner—Ania K Dworzecka

(21) Appl. No.: **29/268,883**

(74) *Attorney, Agent, or Firm*—Birch, Stewart, Kolasch &
Birch, LLP

(22) Filed: **Nov. 15, 2006**

(57) **CLAIM**

(51) **LOC (8) Cl.** **23-03**

The ornamental design for a heater, as shown and described.

(52) **U.S. Cl.** **D23/332**

(58) **Field of Classification Search** D23/317,
D23/314, 332–333, 335, 342, 377, 336–340,
D23/370, 351–352, 328, 325, 383, 380, 341,
D23/381, 382; 416/244 R; 392/360, 165–69,
392/373–76; 312/32 A, 236; 126/90 A, 92 A,
126/110 B, 9 A, 11 D

DESCRIPTION

See application file for complete search history.

FIG. 1 is a left side view of a heater showing my new design;
FIG. 2 is a front view thereof;
FIG. 3 is a right side view thereof;
FIG. 4 is a rear view thereof;
FIG. 5 is a top plan view thereof;
FIG. 6 is a bottom view thereof; and,
FIG. 7 is a perspective view thereof.

(56) **References Cited**

U.S. PATENT DOCUMENTS

D448,837 S * 10/2001 Toro et al. D23/335
D462,429 S * 9/2002 Gao D23/335

1 Claim, 6 Drawing Sheets

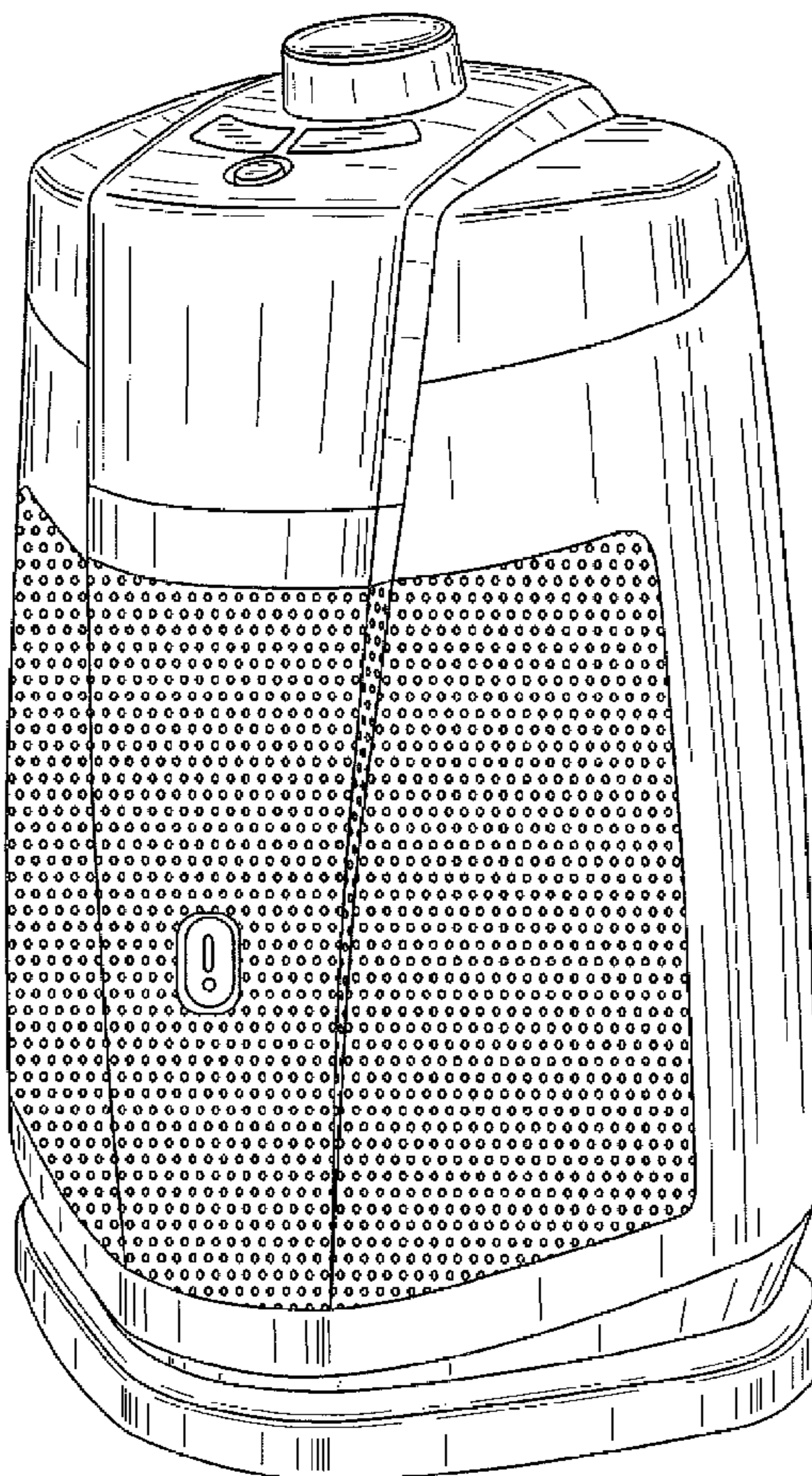

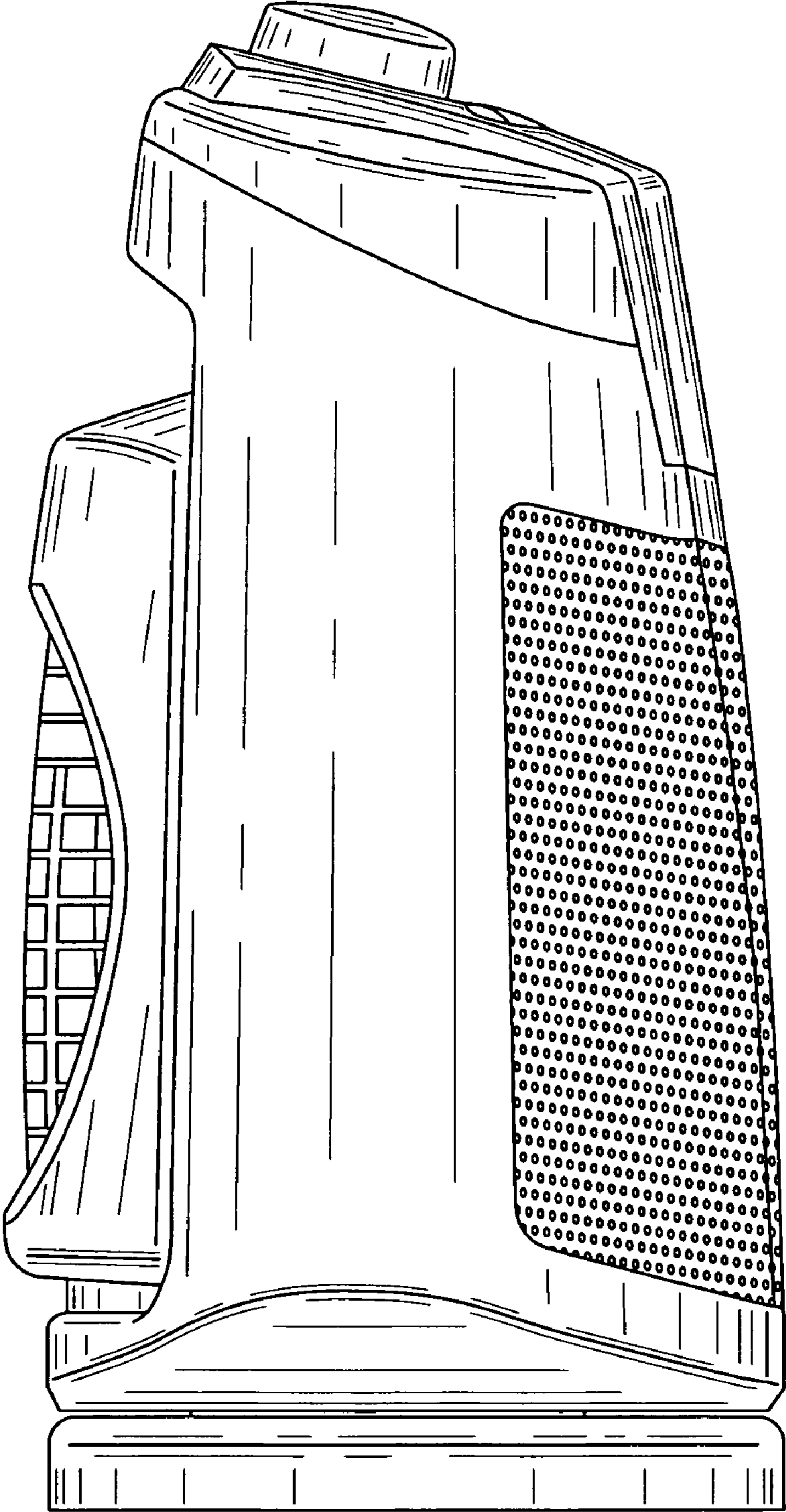

FIG. 1

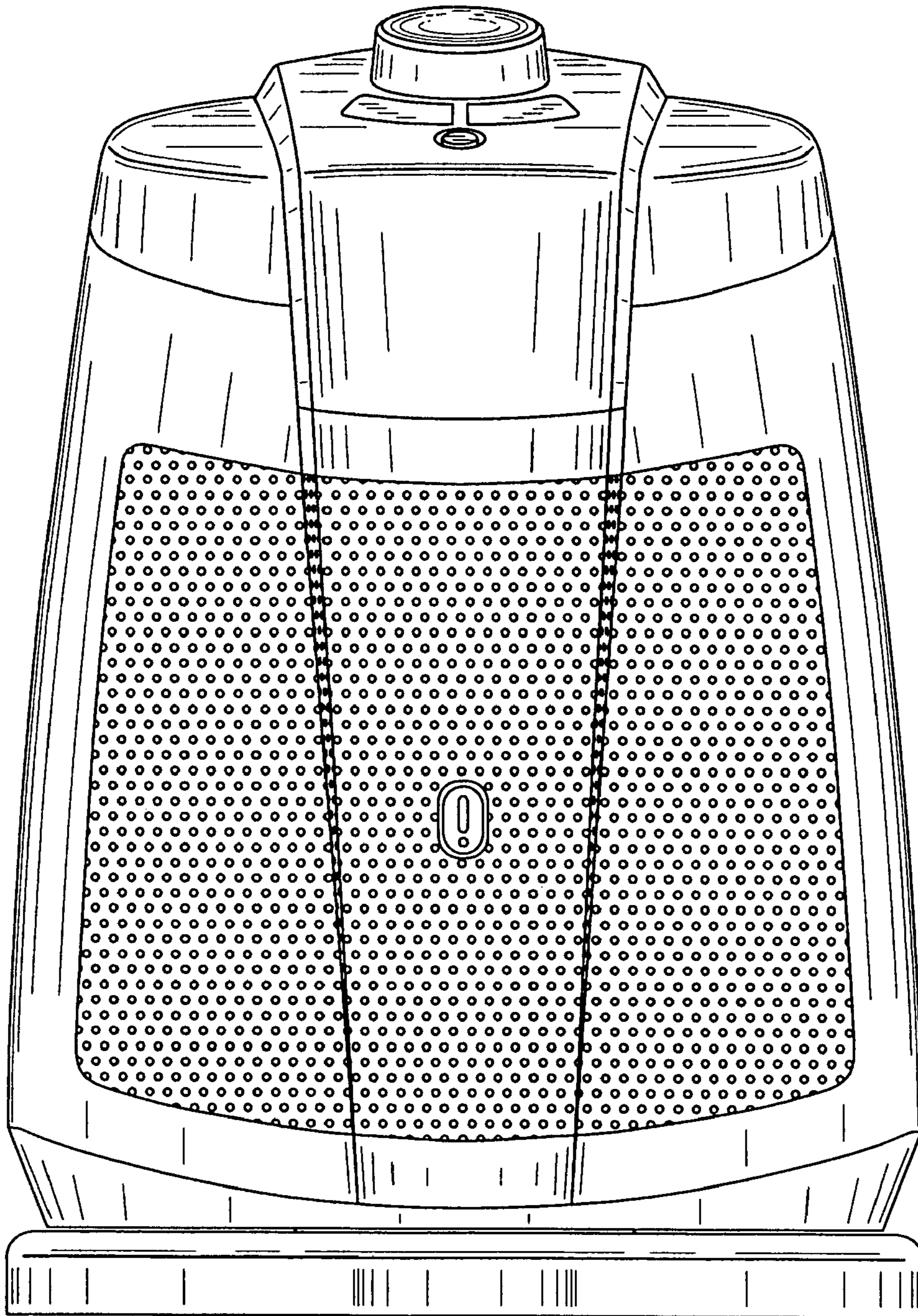

FIG. 2

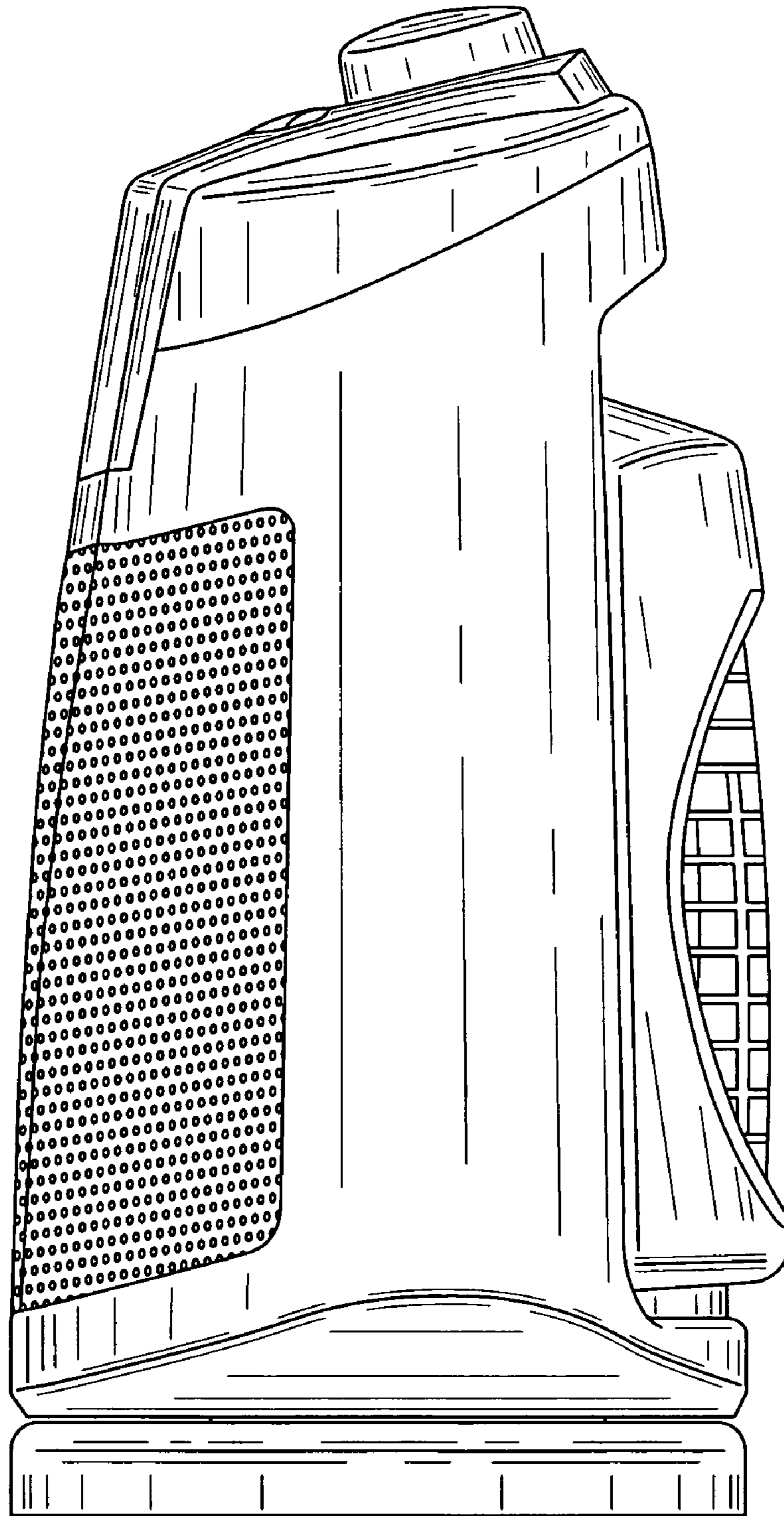

FIG. 3

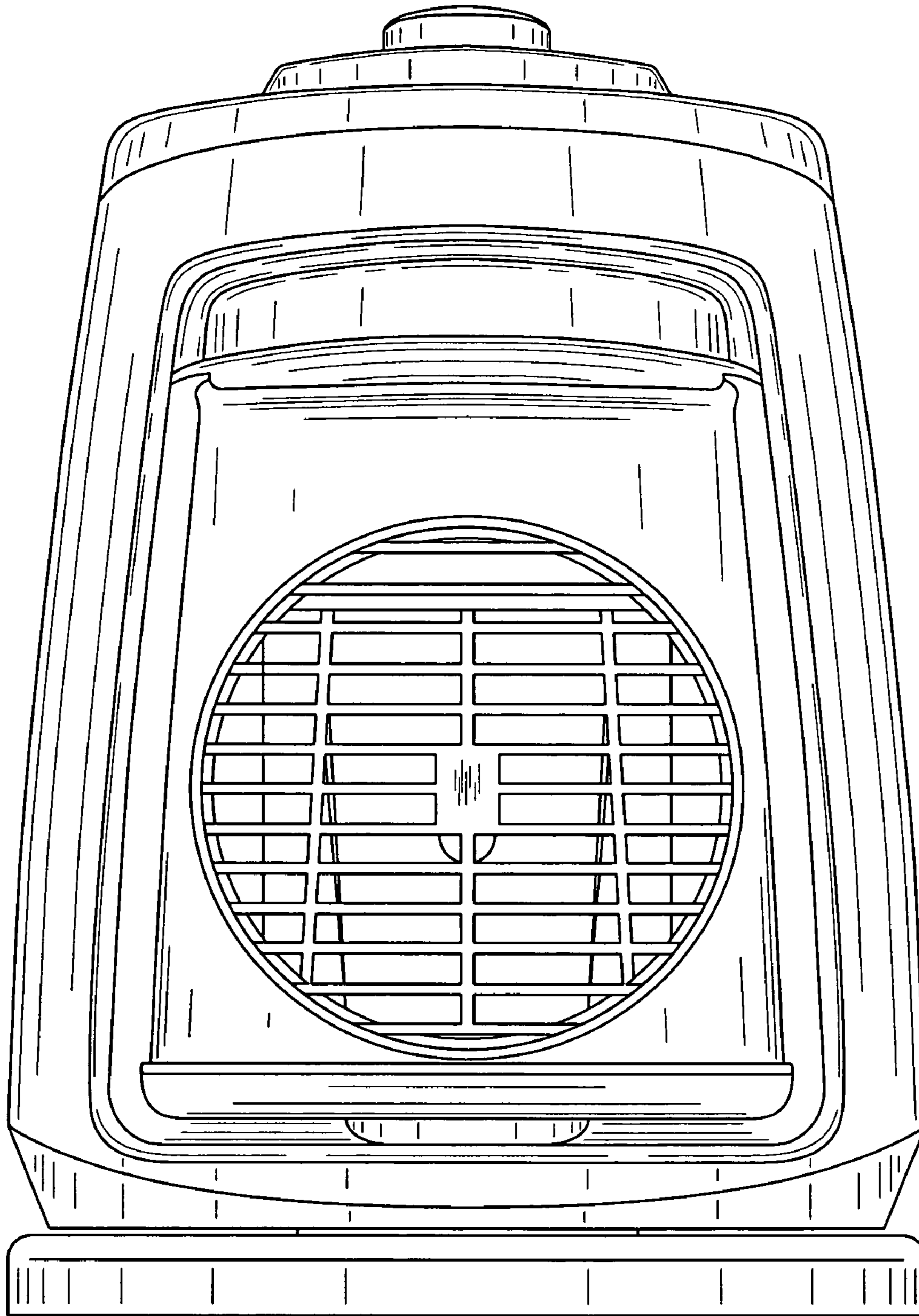

FIG. 4

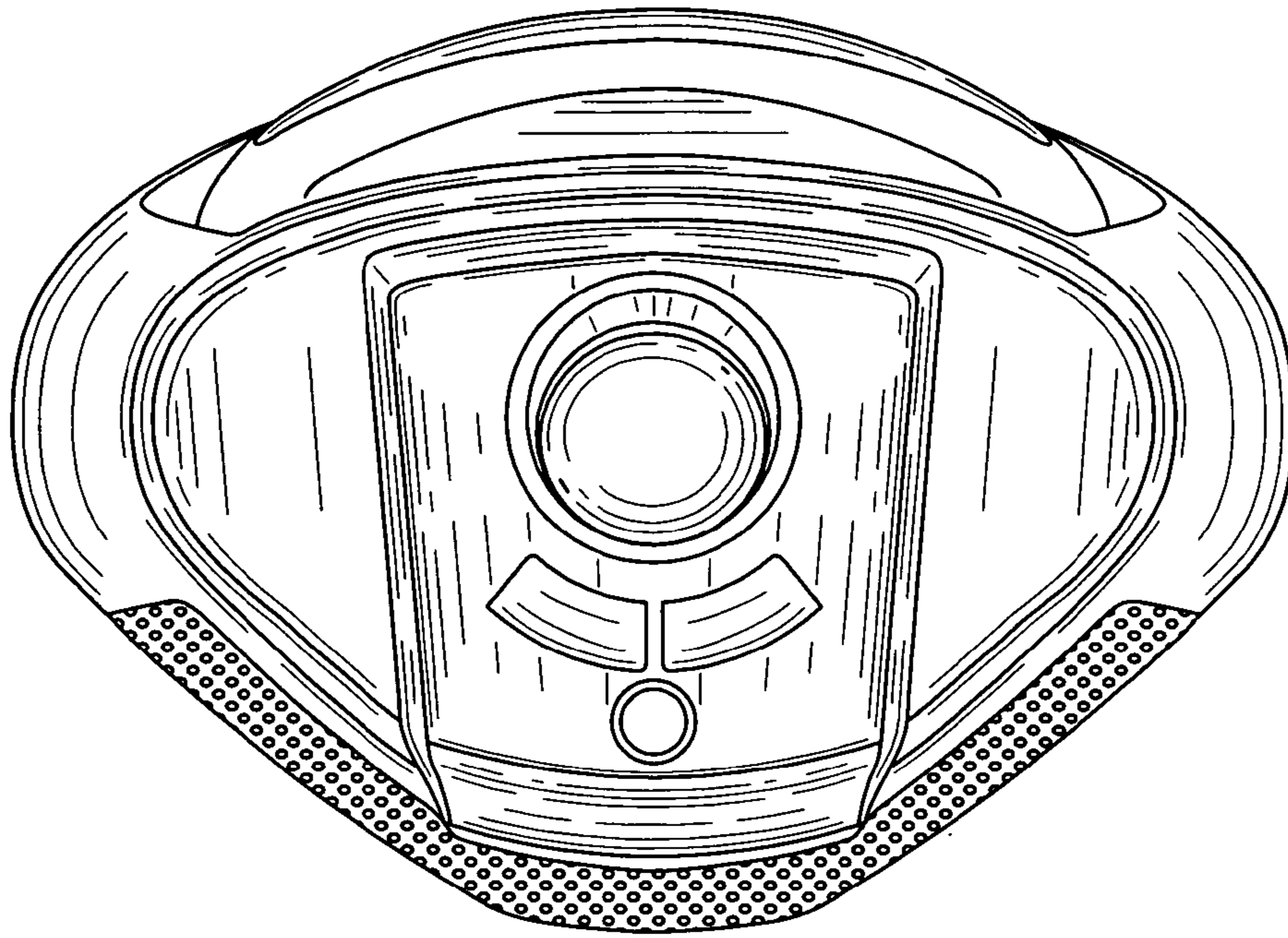

FIG. 5

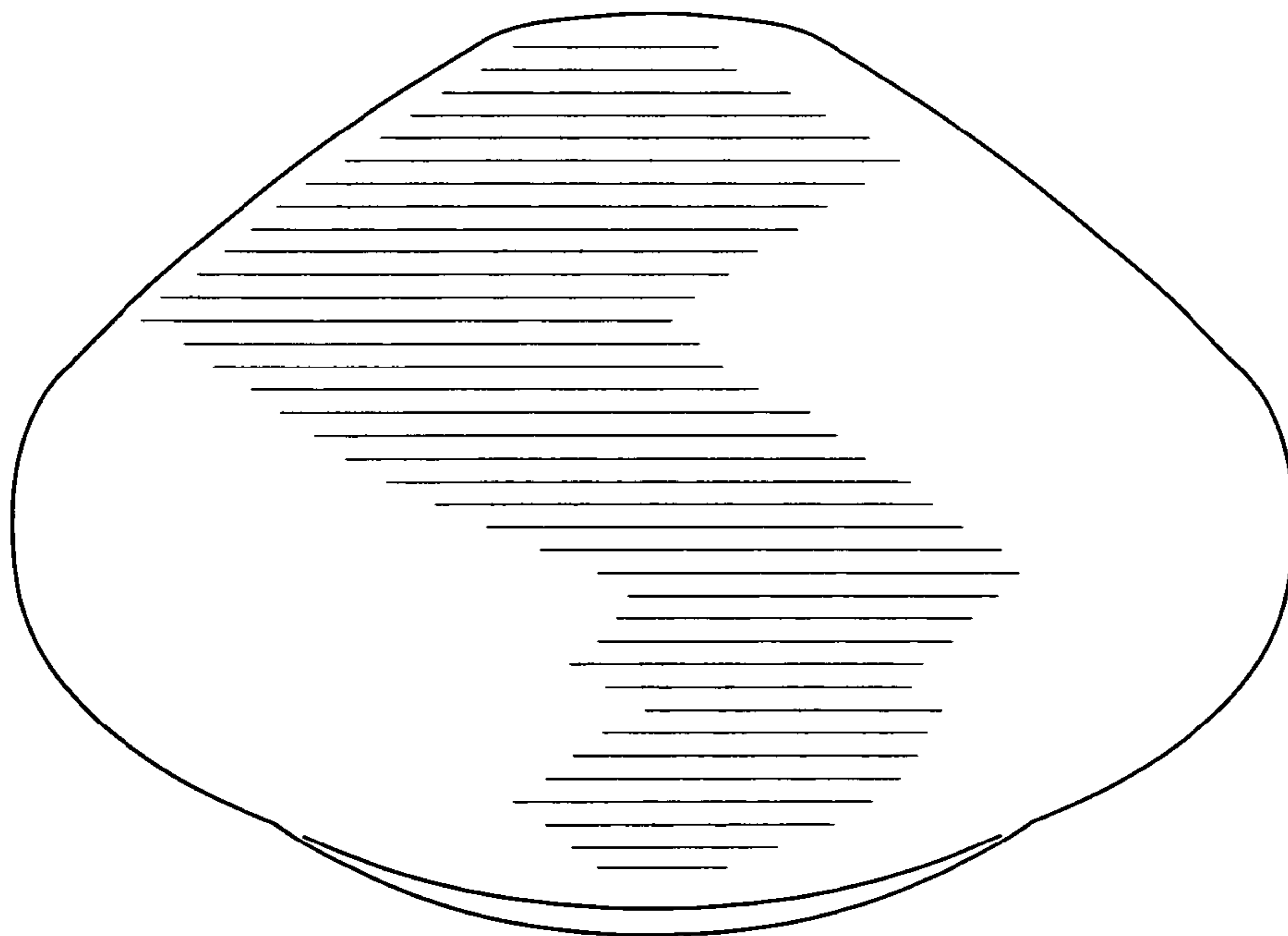

FIG. 6

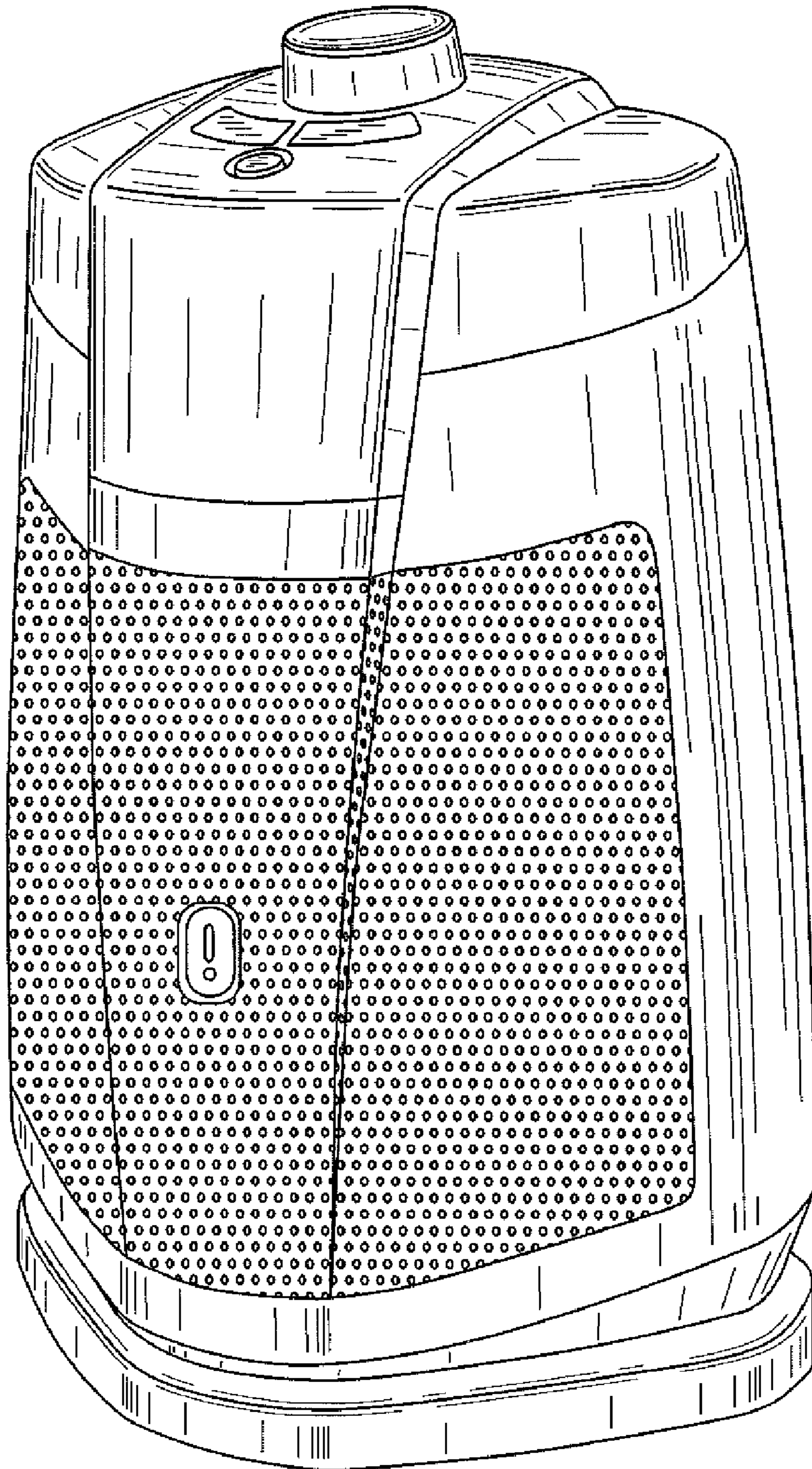

FIG. 7