



US00D578116S

(12) **United States Design Patent**  
**Olcott et al.**

(10) **Patent No.:** **US D578,116 S**  
(45) **Date of Patent:** **\*\* Oct. 7, 2008**

(54) **WIRELESS ROUTER**

(75) Inventors: **Kevin S. Olcott**, Parkland, FL (US);  
**Philip J. Hill**, Oviedo, FL (US); **Jorge I. Rodriguez**, Plantation, FL (US); **Shawn P. Welsh**, Maitland, FL (US); **Yesenia V. Escorcia**, Miramar, FL (US); **Steven D. Pratt**, Yardley, PA (US)

(73) Assignee: **Motorola, Inc.**, Schaumburg, IL (US)

(\*\*) Term: **14 Years**

(21) Appl. No.: **29/248,407**

(22) Filed: **Aug. 15, 2006**

(51) **LOC (8) Cl.** ..... **14-02**

(52) **U.S. Cl.** ..... **D14/240; D14/358**

(58) **Field of Classification Search** ..... D14/356,  
D14/358, 233, 240, 242, 300, 348, 388, 433;  
D13/184, 199, 110, 137.2; 360/69; 379/220.1,  
379/220.14, 25, 93.09, 93.15, 156, 900, 338,  
379/329; 381/124; 607/36

See application file for complete search history.

(56) **References Cited**

**U.S. PATENT DOCUMENTS**

D377,339 S *	1/1997	Beruscha et al.	.....	D13/184
D413,893 S *	9/1999	Luzbetak et al.	.....	D14/240
D475,996 S *	6/2003	Skulley	.....	D14/240
D480,389 S *	10/2003	Schulz et al.	.....	D14/240
D486,829 S *	2/2004	Wang et al.	.....	D14/242
D496,653 S *	9/2004	Townsend et al.	.....	D14/240
D519,512 S *	4/2006	Nishio et al.	.....	D14/433
D541,791 S *	5/2007	Shen	.....	D14/240

D543,513 S \* 5/2007 Allen et al. .... D13/184

\* cited by examiner

*Primary Examiner*—Charles A Rademaker

(74) *Attorney, Agent, or Firm*—Randi L. Karpinia

(57) **CLAIM**

The ornamental design for a wireless router, as shown and described.

**DESCRIPTION**

FIG. 1 is a front, left and top perspective view of a wireless router showing our new design;

FIG. 2 is a front view thereof;

FIG. 3 is a back view thereof;

FIG. 4 is a right view thereof;

FIG. 5 is a left view thereof;

FIG. 6 is a top view thereof;

FIG. 7 is a bottom view thereof;

FIG. 8 is a front, left and top perspective view of a modified embodiment of the design shown in FIGS. 1 through 7;

FIG. 9 is a front view thereof;

FIG. 10 is a back view thereof;

FIG. 11 is a right view thereof;

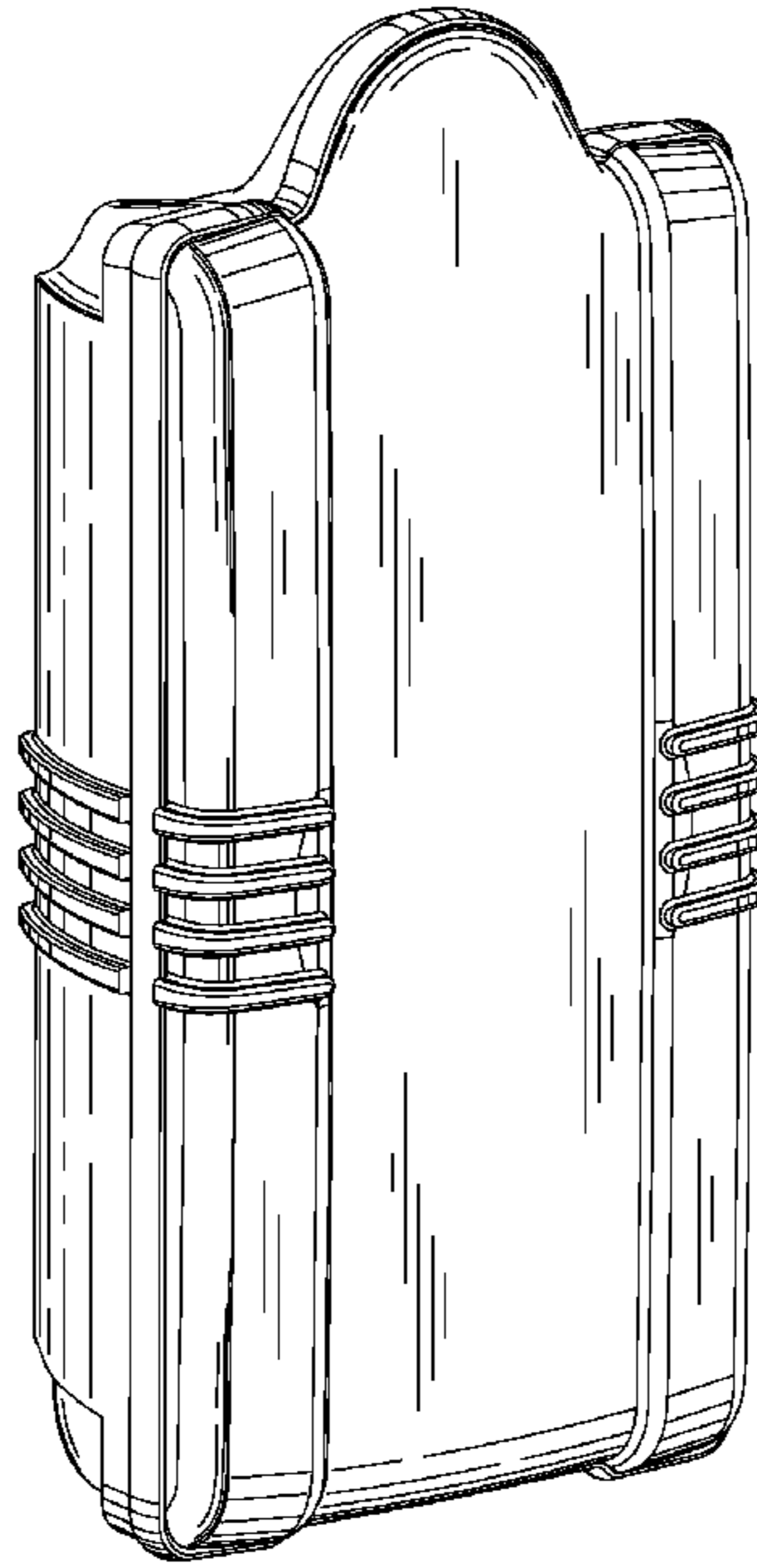
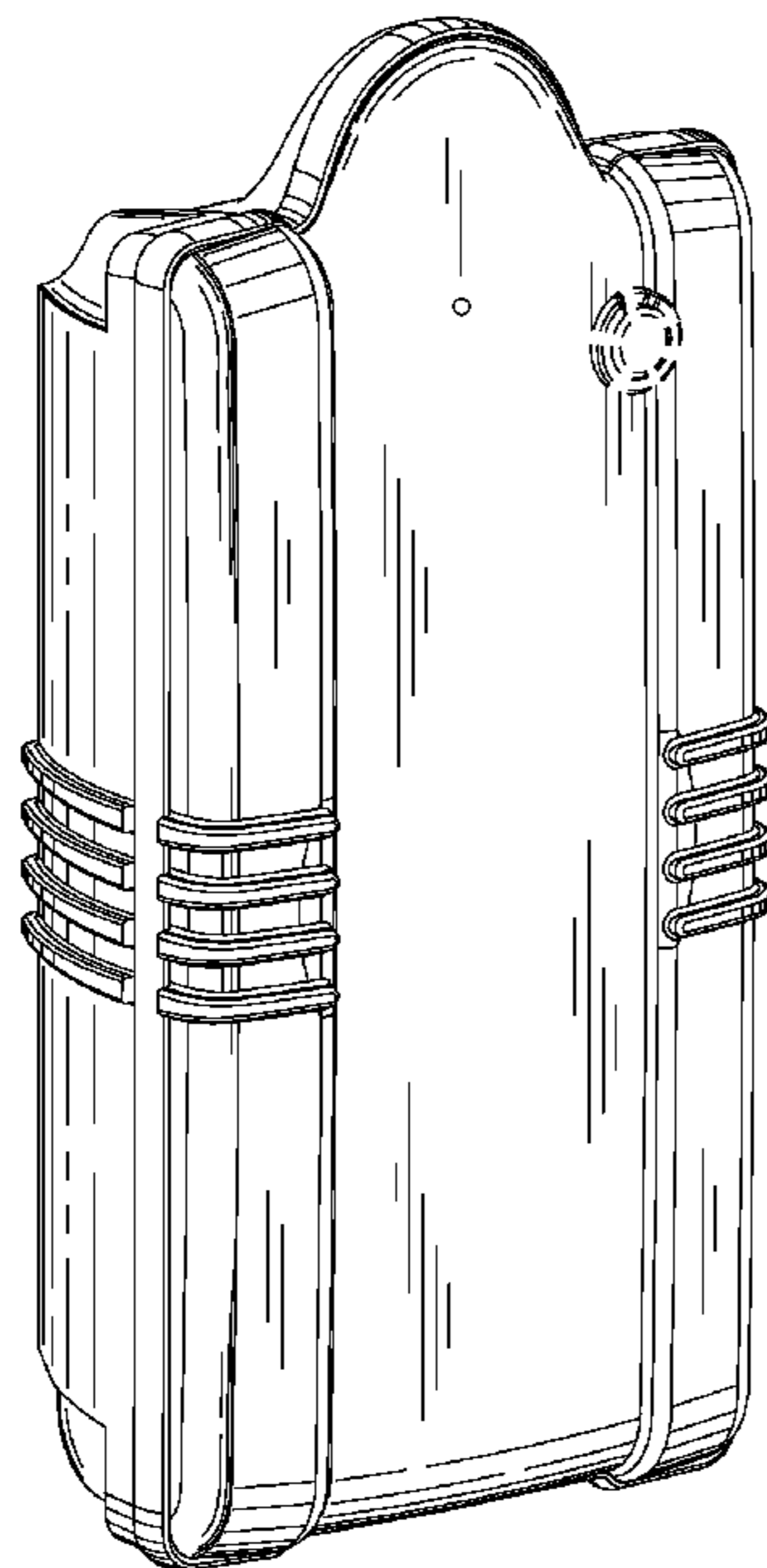
FIG. 12 is a left view thereof;

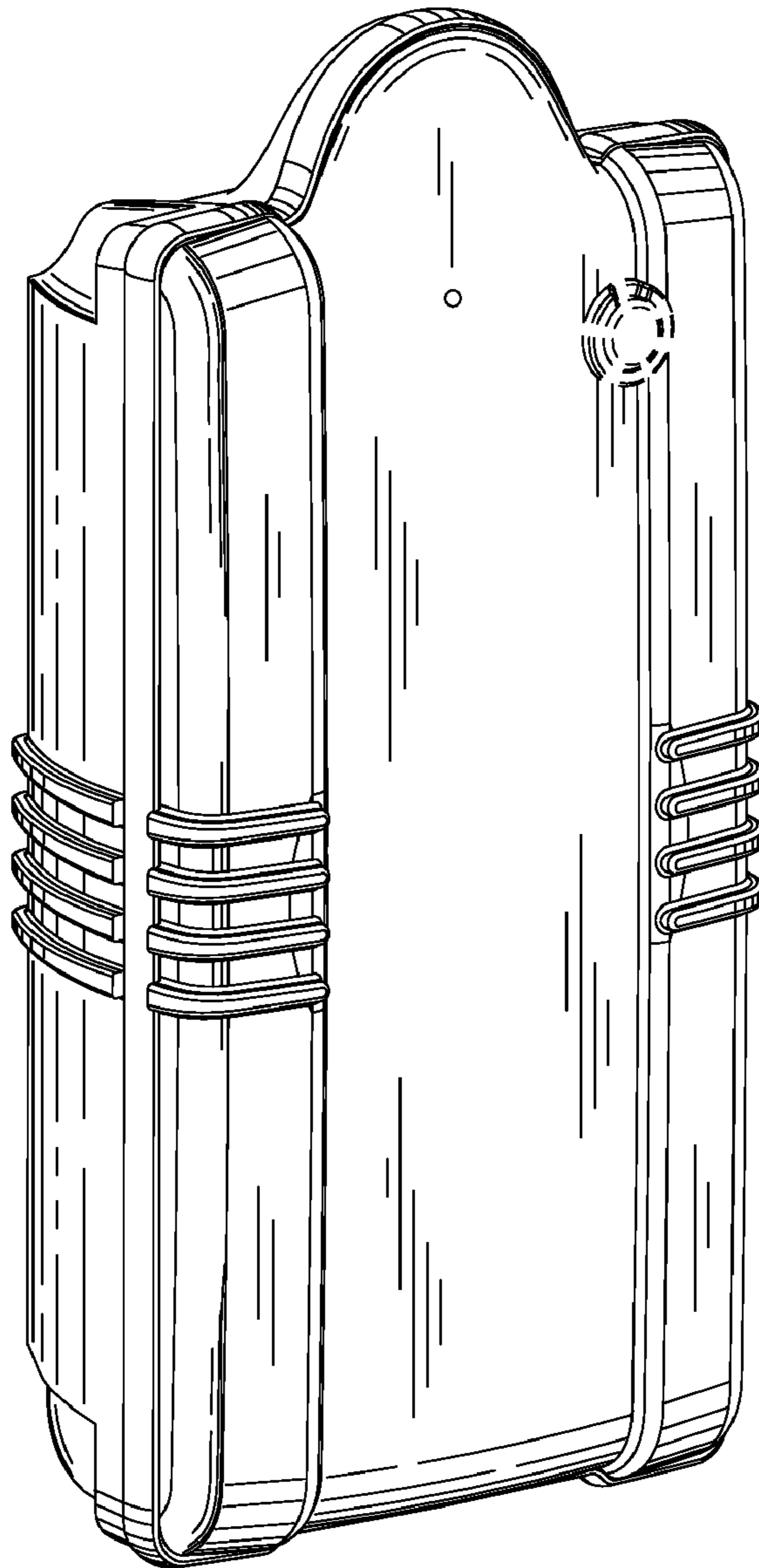
FIG. 13 is a top view thereof; and,

FIG. 14 is a bottom view thereof.

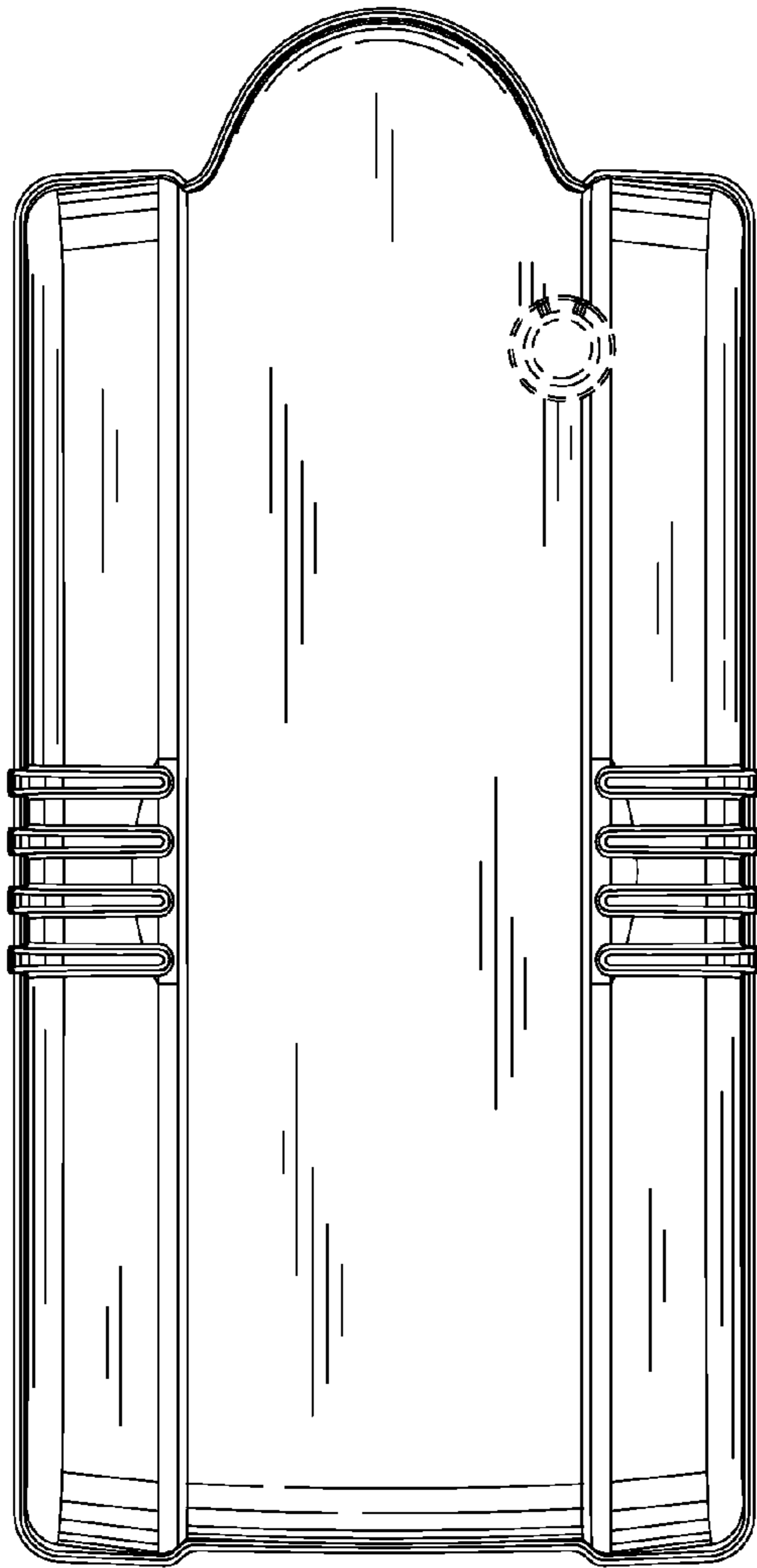
The broken lines shown in FIGS. 1 through 7 show structural environment only and form no part of the claimed design.

**1 Claim, 8 Drawing Sheets**

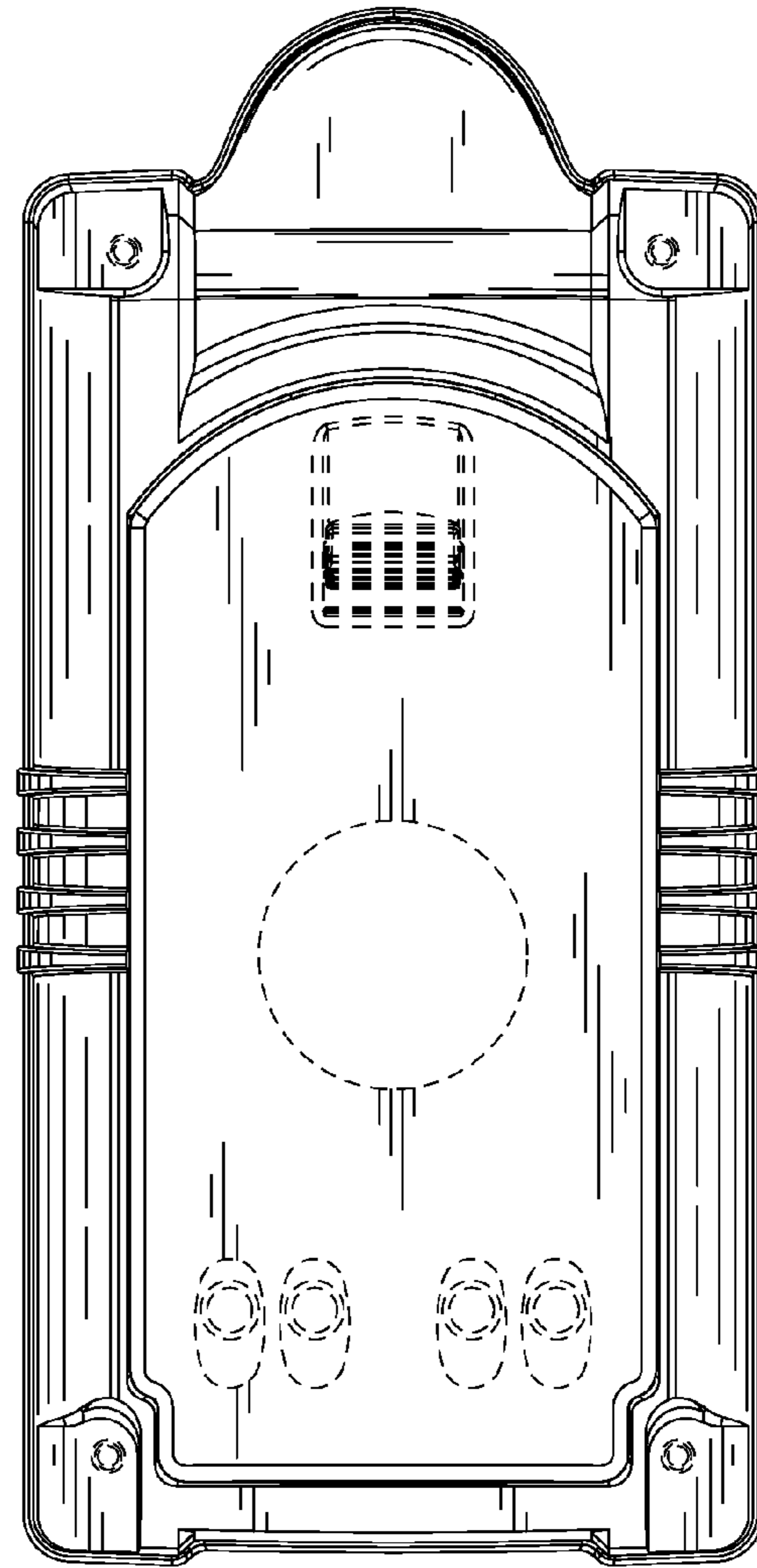




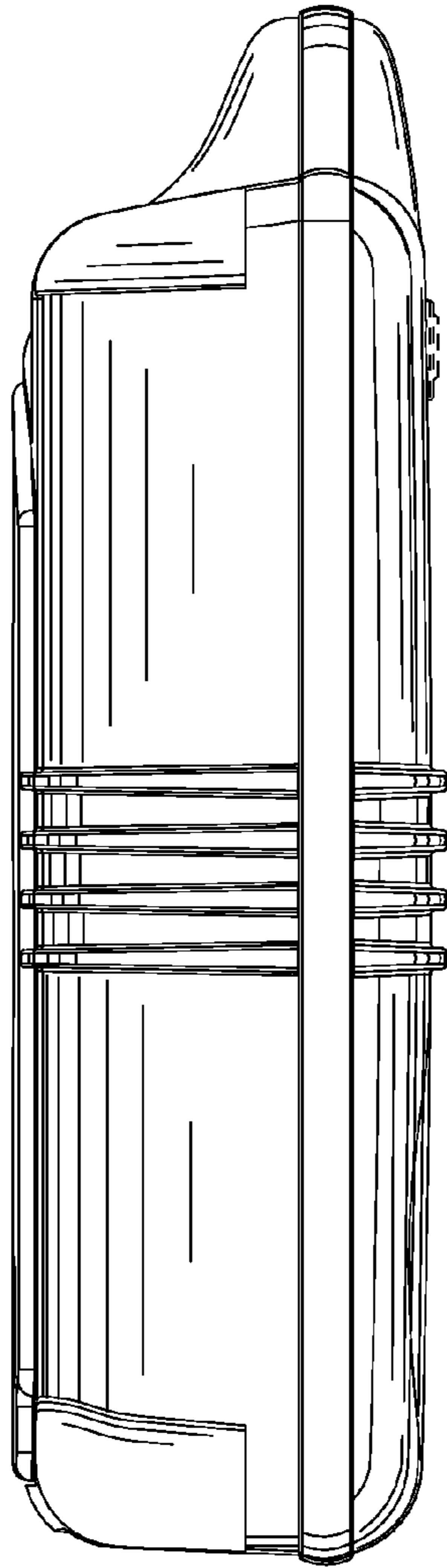
*FIG. 1*



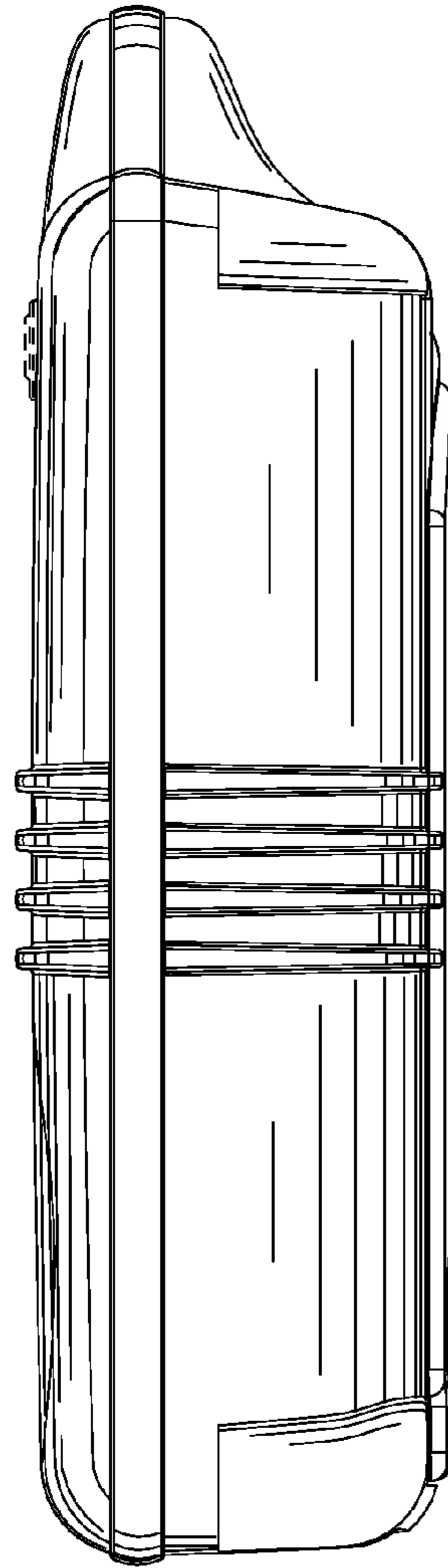
*FIG. 2*



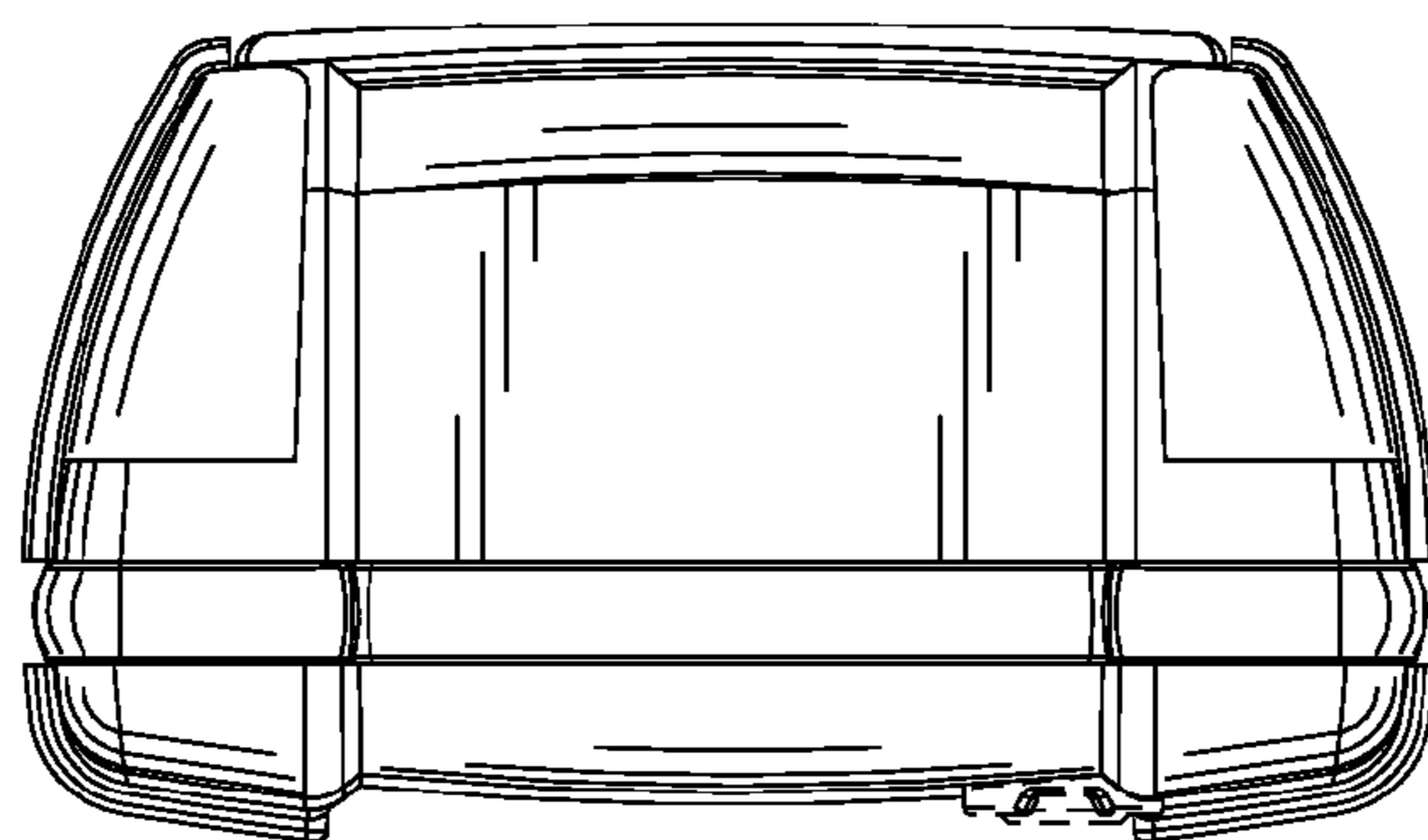
*FIG. 3*



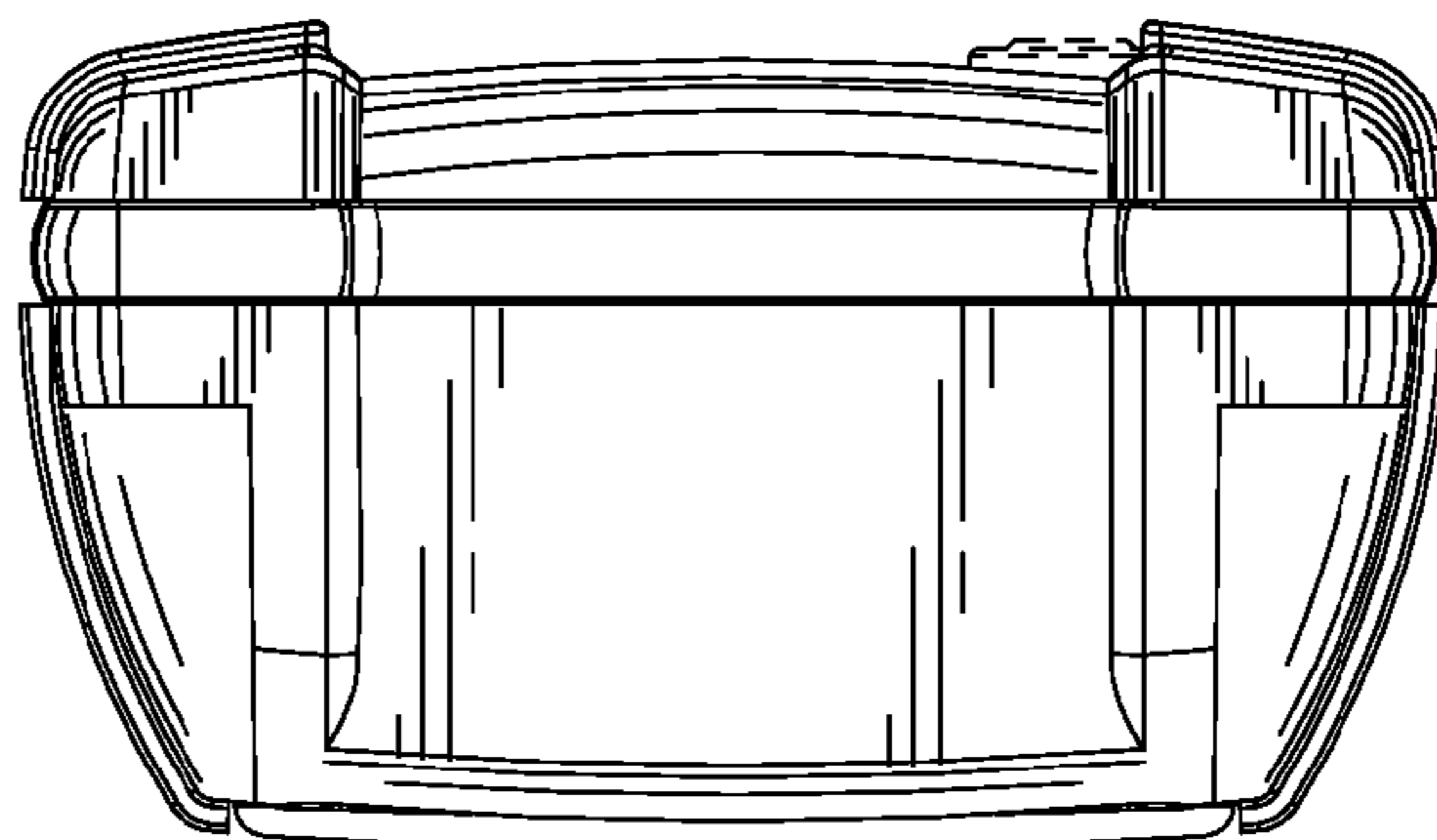
*FIG. 4*



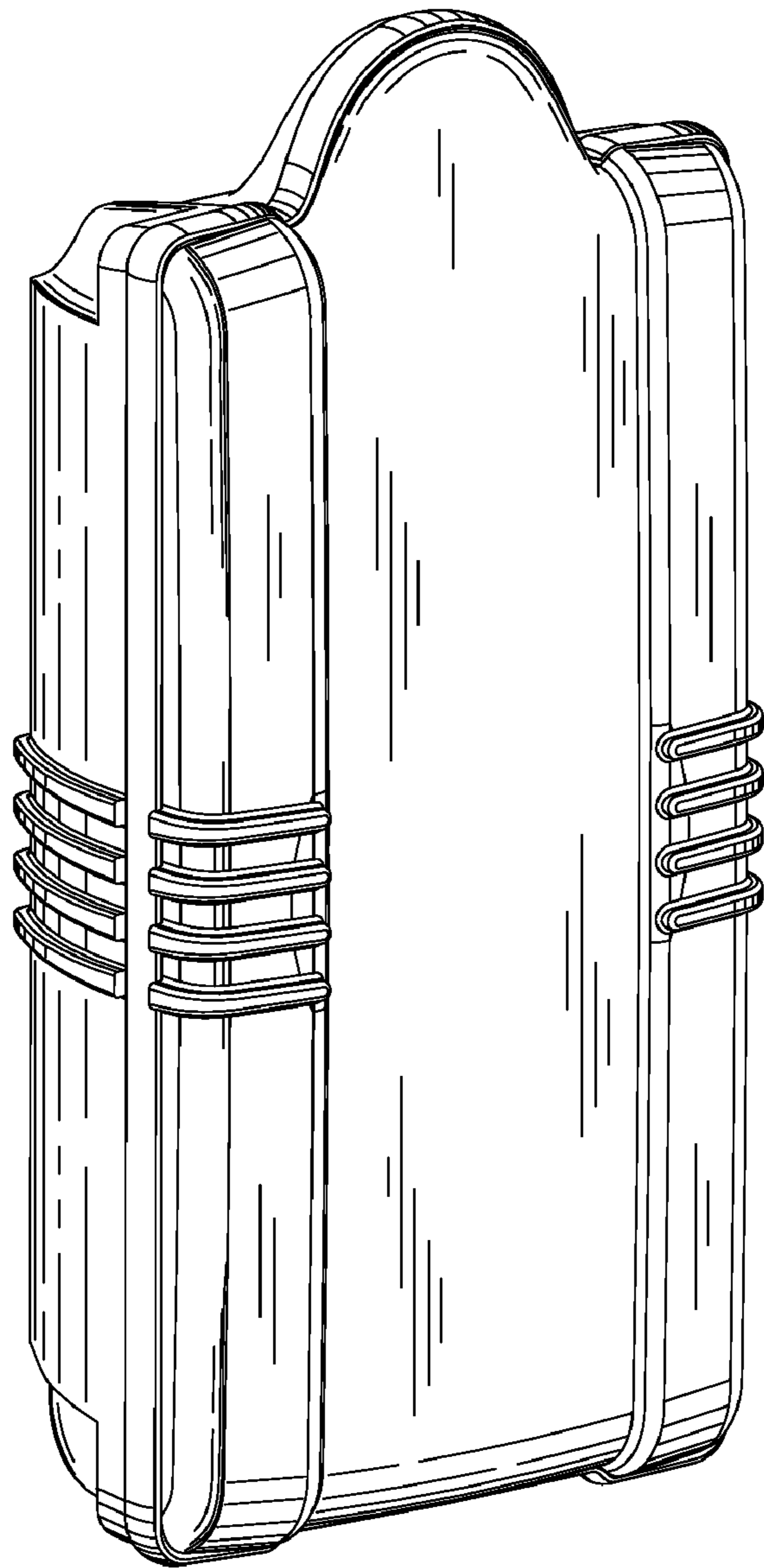
*FIG. 5*



*FIG. 6*

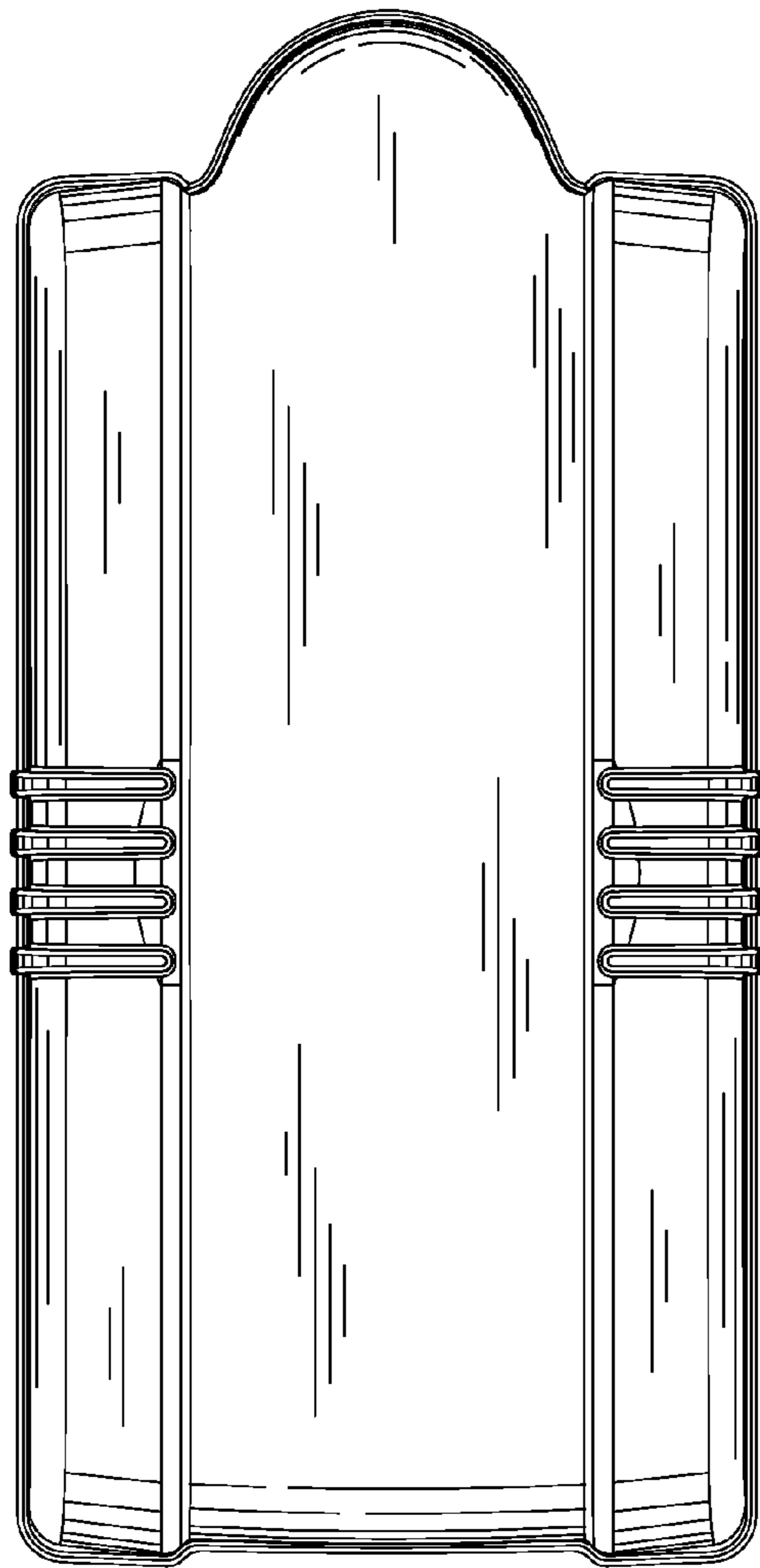


*FIG. 7*

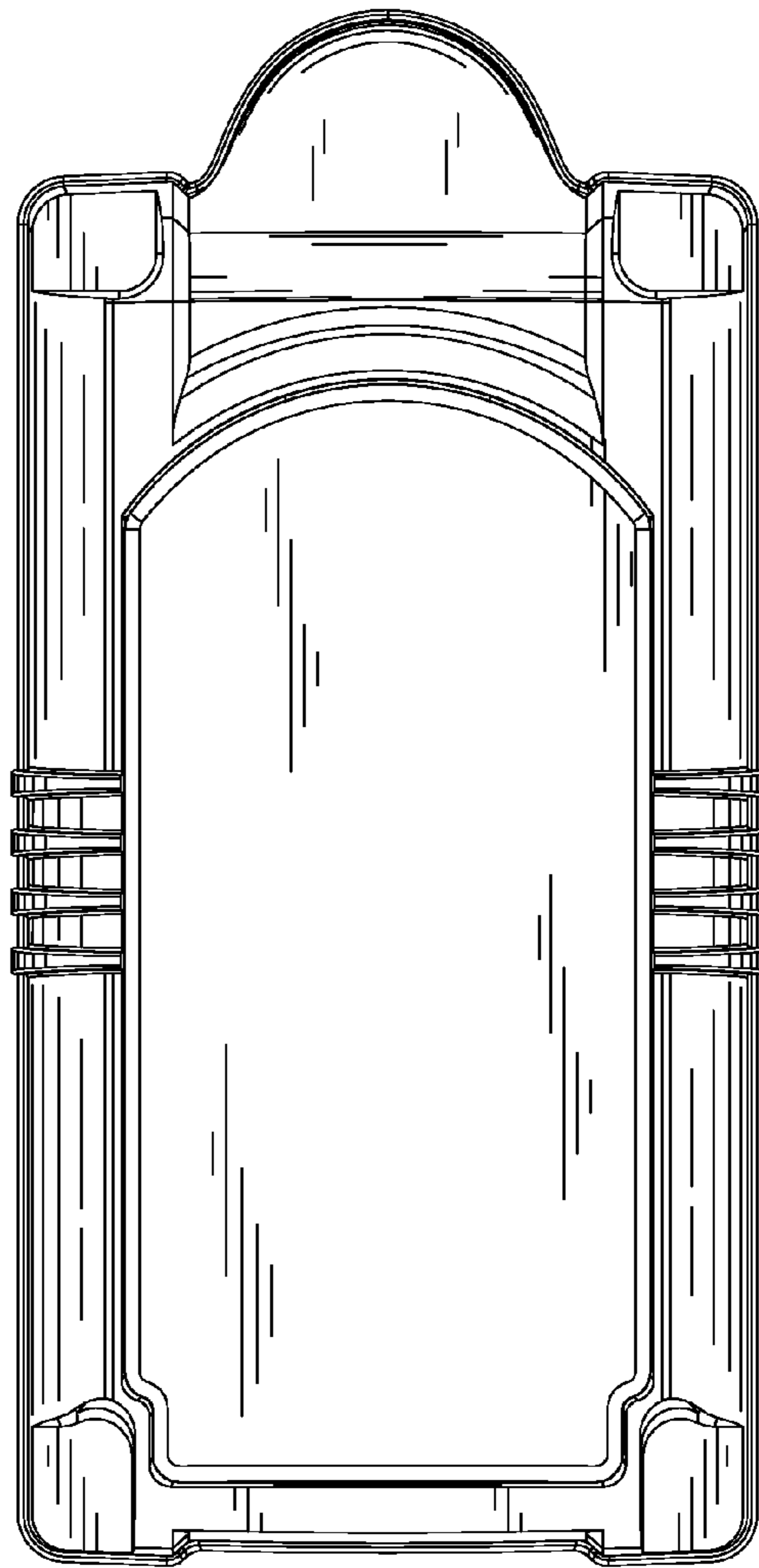


*FIG. 8*

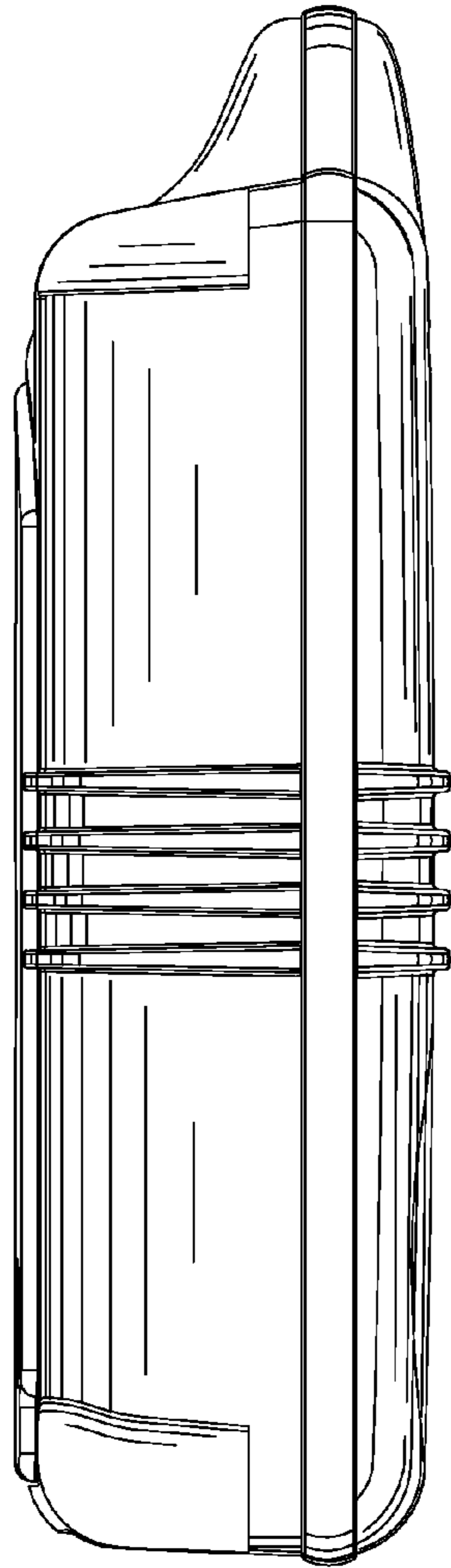




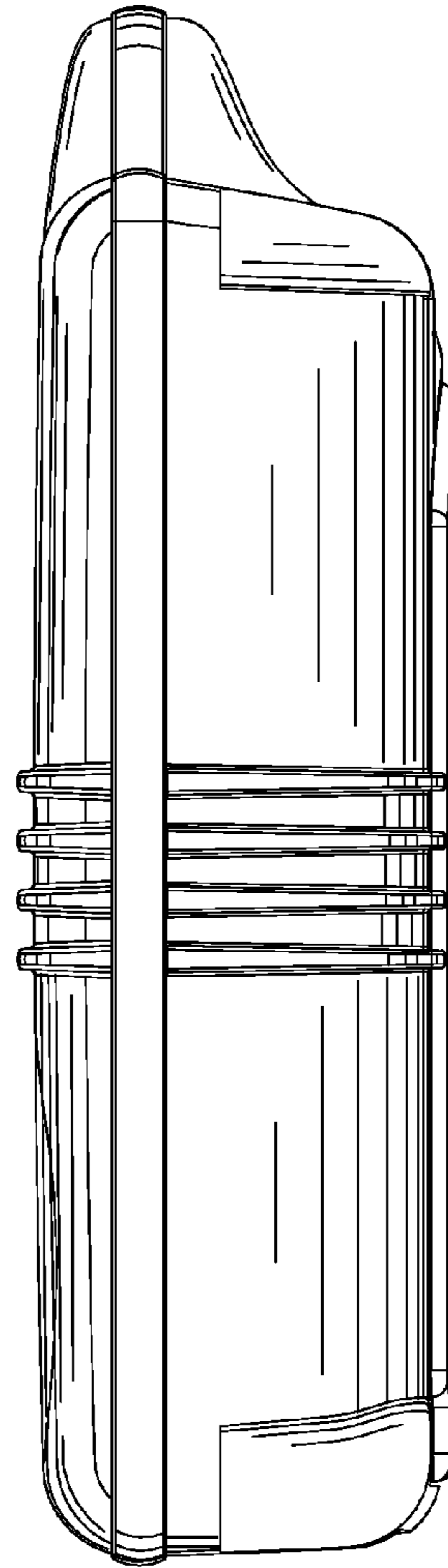
*FIG. 9*



*FIG. 10*

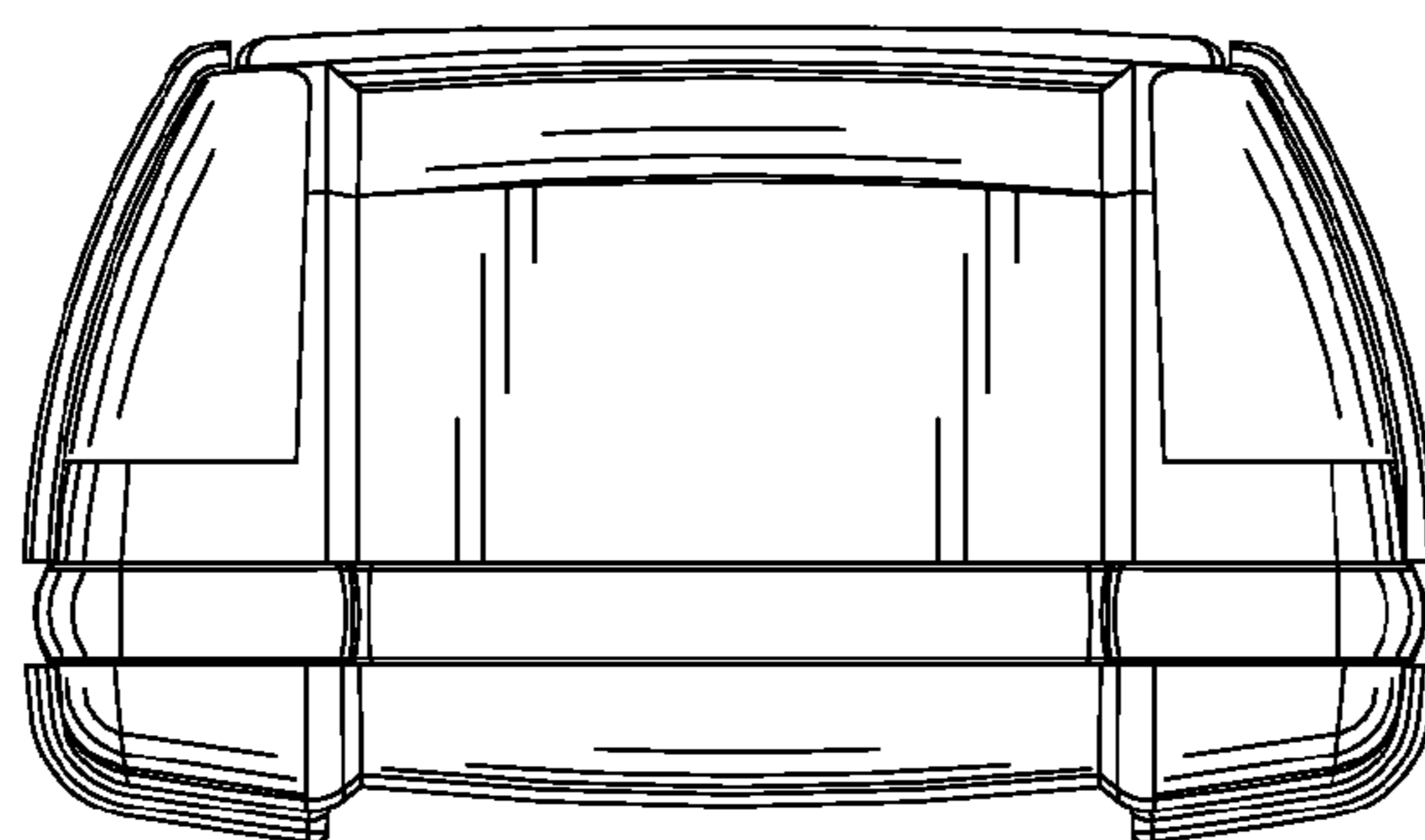


*FIG. 11*

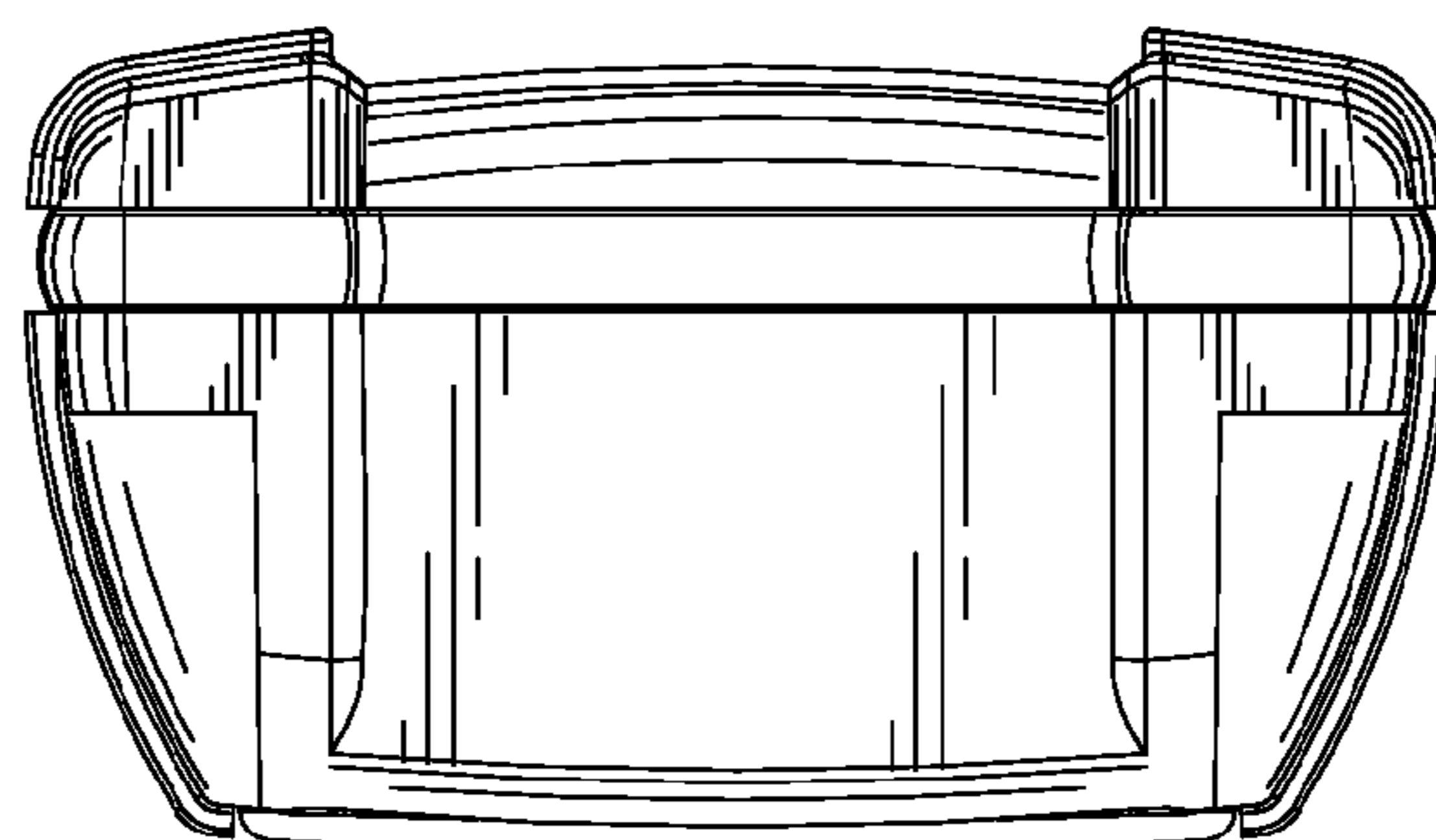


*FIG. 12*





*FIG. 13*



*FIG. 14*