



US00D578099S

(12) **United States Design Patent**  
**Park et al.**

(10) **Patent No.:** **US D578,099 S**  
(45) **Date of Patent:** **\*\* Oct. 7, 2008**

(54) **MOBILE PHONE**

(75) Inventors: **Hyoung-Shin Park**, Seoul (KR);  
**Sang-Min Hyun**, Seoul (KR);  
**Chang-Hwan Hwang**, Goyang-si (KR)

(73) Assignee: **Samsung Electronics Co., Ltd.**,  
Suwon-Si (KR)

(\*\*) Term: **14 Years**

(21) Appl. No.: **29/290,235**

(22) Filed: **Nov. 7, 2007**

(30) **Foreign Application Priority Data**

Aug. 10, 2007 (KR) ..... 30-2007-0034380

(51) **LOC (8) Cl.** ..... **14-03**

(52) **U.S. Cl.** ..... **D14/138**

(58) **Field of Classification Search** ..... D14/137,  
D14/138, 147, 191, 218, 247-248, 341-347,  
D14/496; D10/65, 78, 104; D13/168; D18/7;  
455/556.1, 566, 575.1, 575.3; 345/169  
See application file for complete search history.

(56) **References Cited**

**U.S. PATENT DOCUMENTS**

D496,645	S	*	9/2004	Yoo et al.	.....	D14/138
D504,442	S	*	4/2005	Kim	.....	D14/496
D517,042	S	*	3/2006	Byun et al.	.....	D14/191
D533,564	S	*	12/2006	Kim	.....	D14/496
D533,565	S	*	12/2006	Kim	.....	D14/496
D534,516	S	*	1/2007	Lheem	.....	D14/138
D536,326	S	*	2/2007	Kim et al.	.....	D14/138
D547,743	S	*	7/2007	Kim et al.	.....	D14/138
D549,204	S	*	8/2007	Cho	.....	D14/138
D551,201	S	*	9/2007	Kim et al.	.....	D14/138
7,269,450	B2	*	9/2007	Lee et al.	.....	455/575.1
D554,149	S	*	10/2007	Kim	.....	D14/496
D555,170	S	*	11/2007	Dai	.....	D14/496
D557,239	S	*	12/2007	Lee	.....	D14/138
D559,220	S	*	1/2008	Lee et al.	.....	D14/138
D560,192	S	*	1/2008	Lee et al.	.....	D14/138
D561,155	S	*	2/2008	Kim et al.	.....	D14/138

D563,938	S	*	3/2008	Kim et al.	.....	D14/138
D564,490	S	*	3/2008	Kim et al.	.....	D14/138
D565,598	S	*	4/2008	Park	.....	D14/496
D565,599	S	*	4/2008	Jang et al.	.....	D14/496
7,369,882	B2	*	5/2008	Hwang et al.	.....	455/575.1
2006/0111161	A1	*	5/2006	Cha et al.	.....	455/575.4
2007/0046637	A1	*	3/2007	Choo et al.	.....	345/169
2008/0058009	A1	*	3/2008	Ko et al.	.....	455/556.1
2008/0119248	A1	*	5/2008	Nissen et al.	.....	455/575.4

**OTHER PUBLICATIONS**

Sharp TM100, announced 1<sup>st</sup> quarter 2004, [online], [retrieved on Feb. 20, 2007]. Retrieved from Internet ,<URL: http://www.gsmarena.com>.\*

Asus P535, announced Nov. 2006, [online], [retrieved on Feb. 20, 2007]. Retrieved from Internet ,<URL: http://www.gsmarena.com>.\*

Samsung F700, announced Feb. 2007, [online], [retrieved on Feb. 8, 2007]. Retrieved from Internet ,<URL: http://www.gsmarena.com>.\*

\* cited by examiner

*Primary Examiner*—Jeffrey D. Asch

*Assistant Examiner*—Bridget L Eland

(74) *Attorney, Agent, or Firm*—Staas & Halsey LLP

(57) **CLAIM**

The ornamental design for a mobile phone, as shown and described.

**DESCRIPTION**

FIG. 1 is a perspective view of a mobile phone;  
FIG. 2 is a front view of the mobile phone of FIG. 1;  
FIG. 3 is a rear view of the mobile phone of FIG. 1;  
FIG. 4 is left-side of the mobile phone of FIG. 1;  
FIG. 5 is right-side of the mobile phone of FIG. 1;  
FIG. 6 is top plan view of the mobile phone of FIG. 1;  
FIG. 7 is bottom plan view of the mobile phone of FIG. 1; and,  
FIG. 8 is an open perspective view of the mobile phone of FIG. 1, where the display portion is slid upward.

**1 Claim, 6 Drawing Sheets**

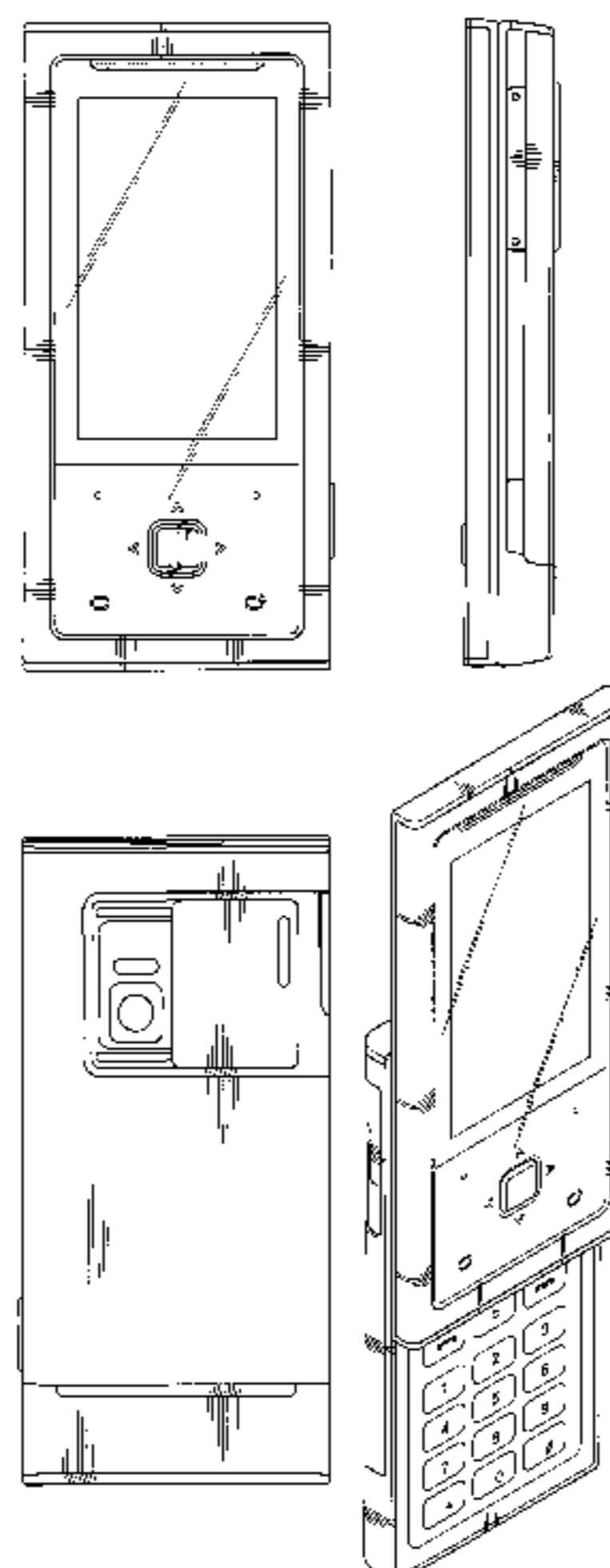
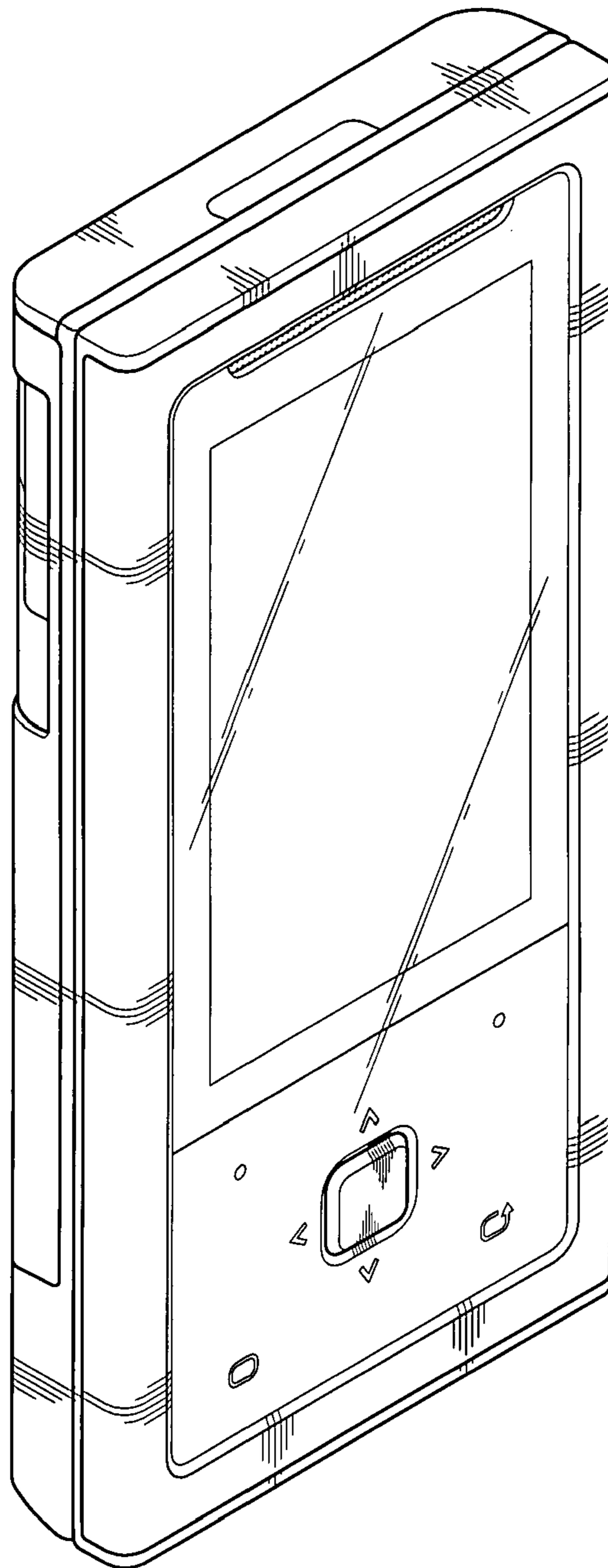

FIG. 1



# FIG. 2

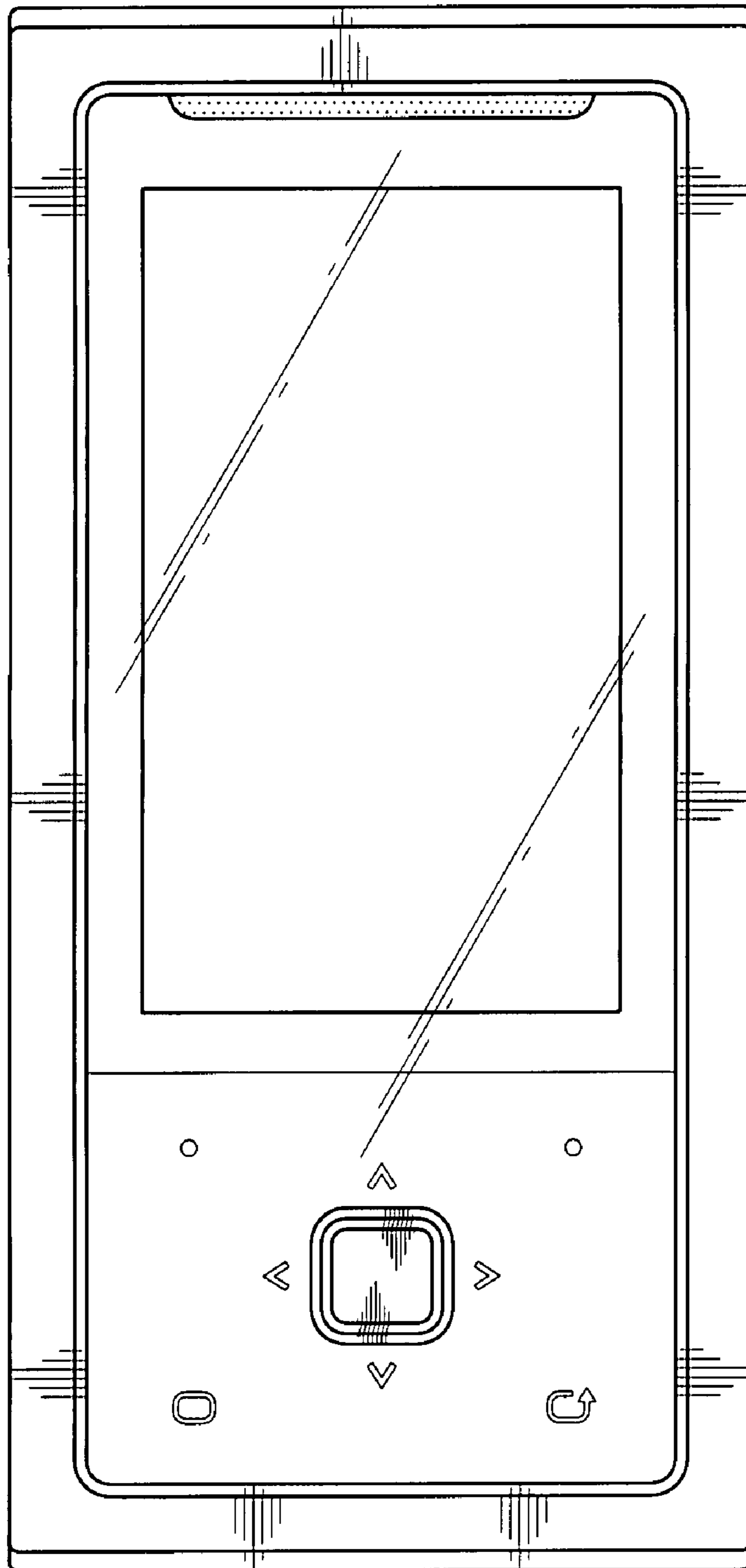

FIG. 3

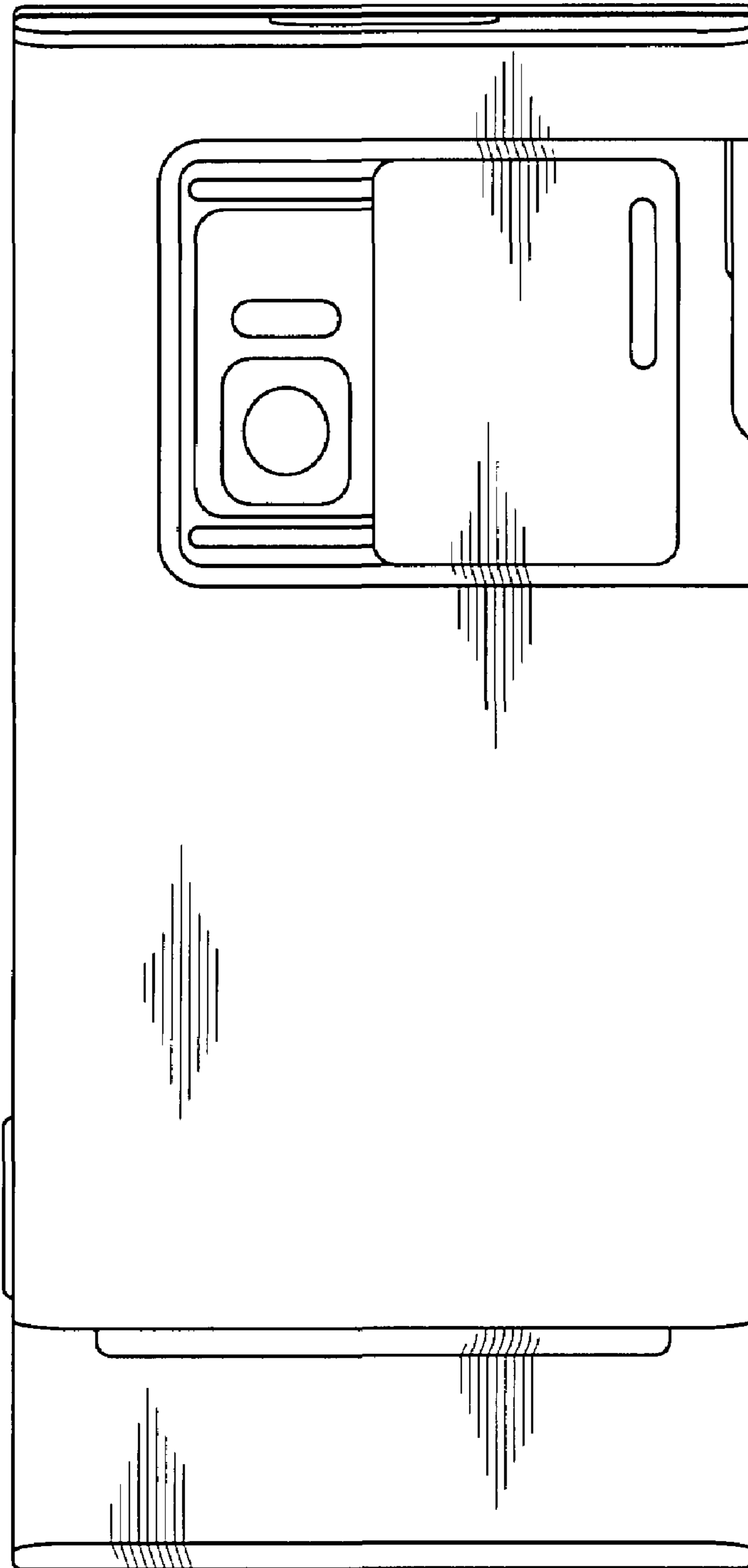

FIG. 4

FIG. 5

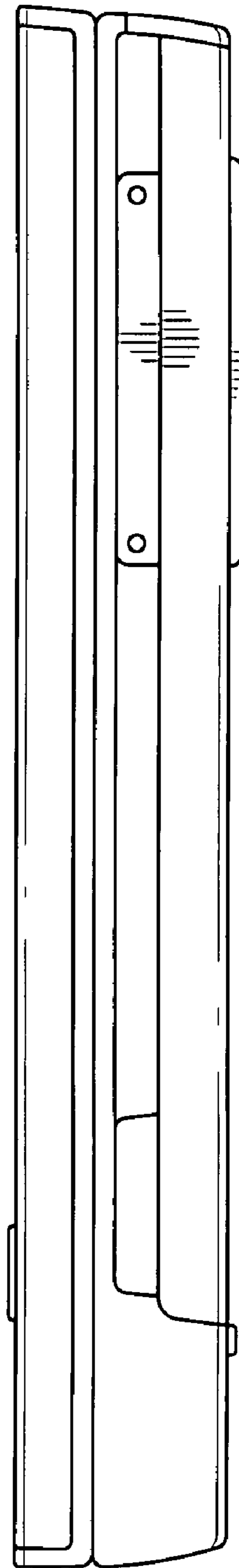
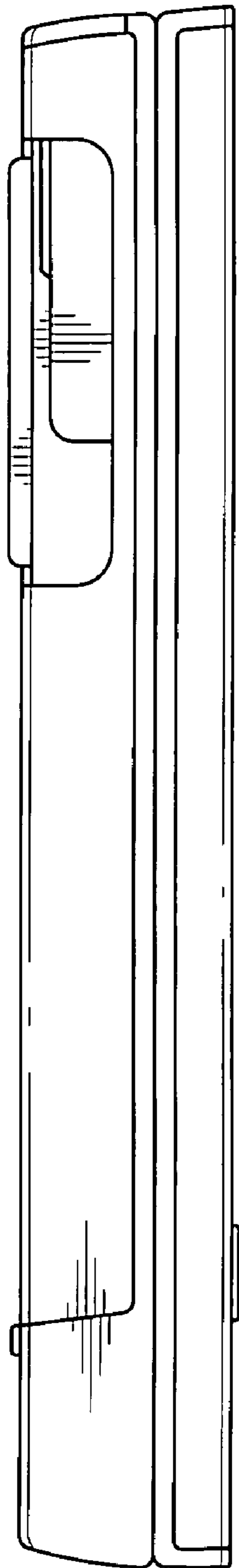

FIG. 6

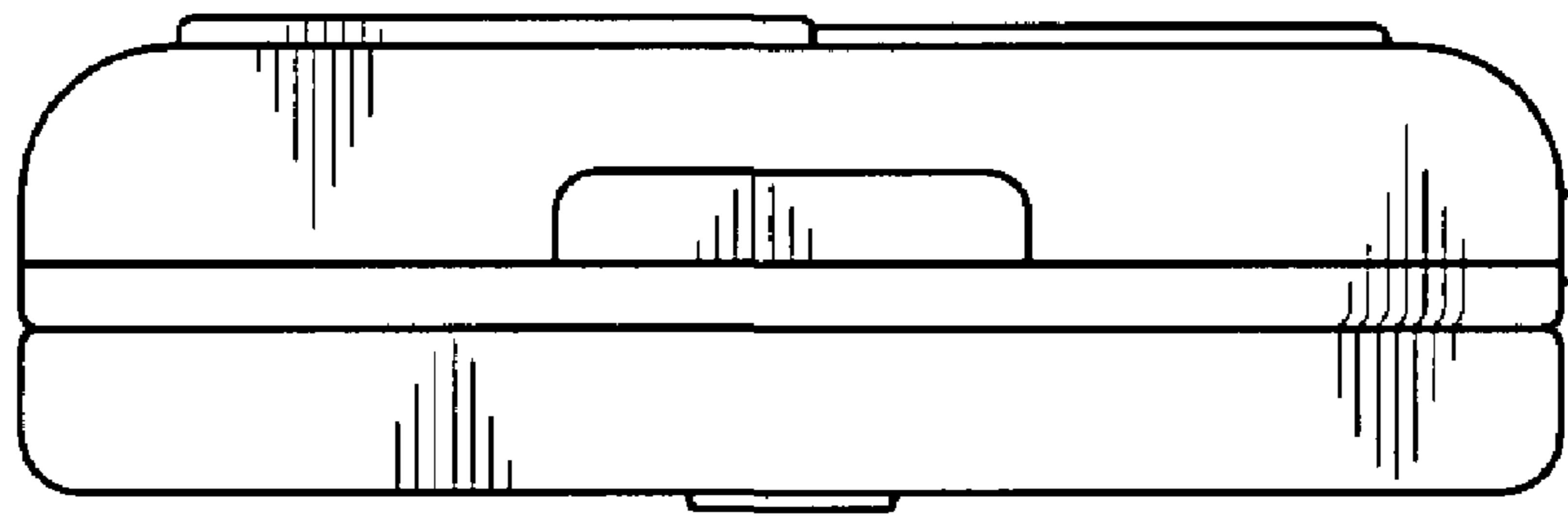

FIG. 7

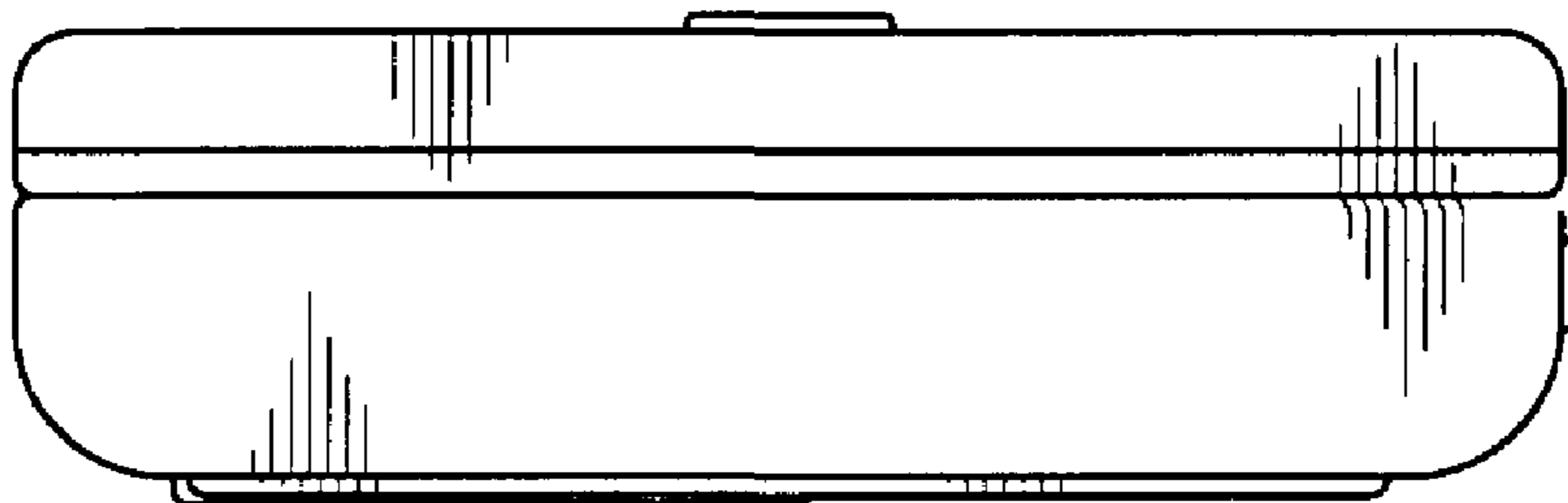

FIG. 8

