



US00D578026S

(12) **United States Design Patent**
Roher et al.

(10) **Patent No.:** **US D578,026 S**
(45) **Date of Patent:** **** Oct. 7, 2008**

(54) **THERMOSTAT**

(75) Inventors: **Michael A. Roher**, Fort Wayne, IN (US); **Tim Comerford**, Indianapolis, IN (US); **Jayashanger Goundiah Ramasamy**, Indianapolis, IN (US); **Gary D. Wedlake**, Huntington, IN (US)

(73) Assignee: **Carrier Corporation**, Farmington, CT (US)

(**) Term: **14 Years**

(21) Appl. No.: **29/291,492**

(22) Filed: **Aug. 31, 2007**

(51) **LOC (8) Cl.** **10-04**

(52) **U.S. Cl.** **D10/50**

(58) **Field of Classification Search** D10/49-50;
236/46 R, 47, 49.3, 51, 84, 94; 400/485
See application file for complete search history.

(56) **References Cited**

U.S. PATENT DOCUMENTS

D255,103 S 5/1980 Wolfe

(Continued)

Primary Examiner—Antoine D Davis

(74) *Attorney, Agent, or Firm*—Kinney & Lange P.A.

(57) **CLAIM**

The ornamental design for a thermostat, as shown and described.

DESCRIPTION

FIG. 1 is a perspective view of a first embodiment;

FIG. 2 is a left side view of a first embodiment;

FIG. 3 is a right side view of a first embodiment;

FIG. 4 is a front view of a first embodiment;

FIG. 5 is a rear view of a first embodiment;

FIG. 6 is a top view of a first embodiment;

FIG. 7 is a bottom view of a first embodiment;

FIG. 8 is a perspective view of a second embodiment;

FIG. 9 is a left side view of a second embodiment;

FIG. 10 is a right side view of a second embodiment;

FIG. 11 is a front view of a second embodiment;

FIG. 12 is a rear view of a second embodiment;

FIG. 13 is a top view of a second embodiment;

FIG. 14 is a bottom view of a second embodiment;

FIG. 15 is a perspective view of a third embodiment;

FIG. 16 is a left side view of a third embodiment;

FIG. 17 is a right side view of a third embodiment;

FIG. 18 is a front view of a third embodiment;

FIG. 19 is a rear view of a third embodiment;

FIG. 20 is a top view of a third embodiment;

FIG. 21 is a bottom view of a third embodiment;

FIG. 22 is a perspective view of a fourth embodiment;

FIG. 23 is a left side view of a fourth embodiment;

FIG. 24 is a right side view of a fourth embodiment;

FIG. 25 is a front view of a fourth embodiment;

FIG. 26 is a rear view of a fourth embodiment;

FIG. 27 is a top view of a fourth embodiment; and,

FIG. 28 is a bottom view of a fourth embodiment.

The broken line showing of structural features is included for the purpose of illustrating non-claimed subject matter and forms no part of the claimed design.

1 Claim, 12 Drawing Sheets

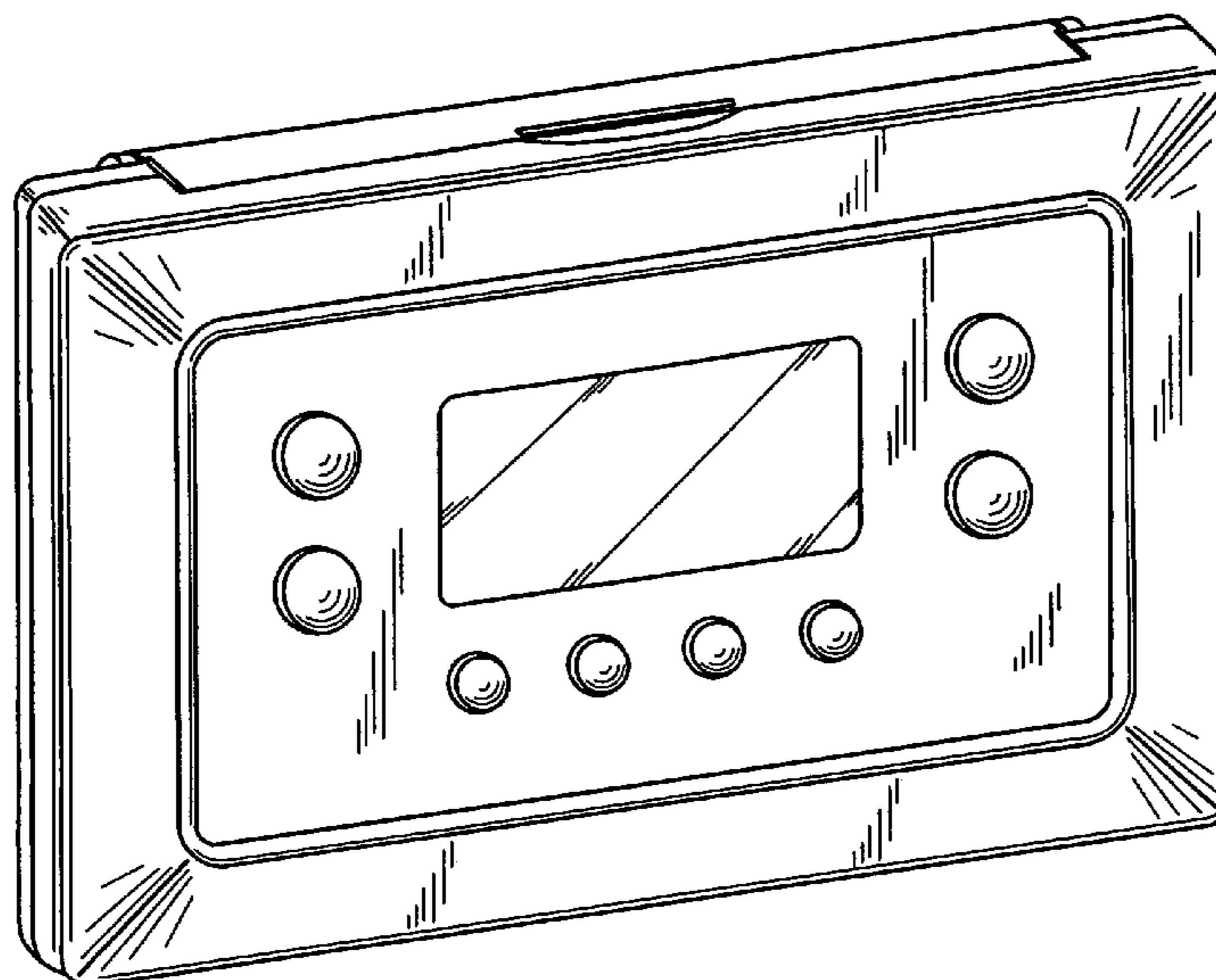

US D578,026 S

Page 2

U.S. PATENT DOCUMENTS

D268,252 S	3/1983	Chambers	D429,169 S	8/2000	Ohlwine et al.
D304,911 S	12/1989	Parker et al.	D518,744 S	4/2006	Rosen
D315,519 S	3/1991	Odom, Jr. et al.	D524,663 S	7/2006	Moore
D359,459 S	6/1995	Summa et al.	D525,154 S	7/2006	Moore
D360,146 S	7/1995	Gaskell et al.	D527,658 S	9/2006	Moore
D386,989 S	12/1997	Gee, II	D531,527 S	11/2006	Moore
D386,990 S	12/1997	Gee, II	D536,271 S	2/2007	Moore
D403,972 S	1/1999	Gaskell et al.	D541,184 S *	4/2007	Barton et al. D10/50
D412,672 S	8/1999	Ohlwine et al.	D556,060 S	11/2007	McGuire et al.
D413,073 S	8/1999	Brechbill et al.	D556,061 S	11/2007	Rosen
D425,801 S	5/2000	Brechbill et al.	D556,608 S	12/2007	Rhodes

* cited by examiner

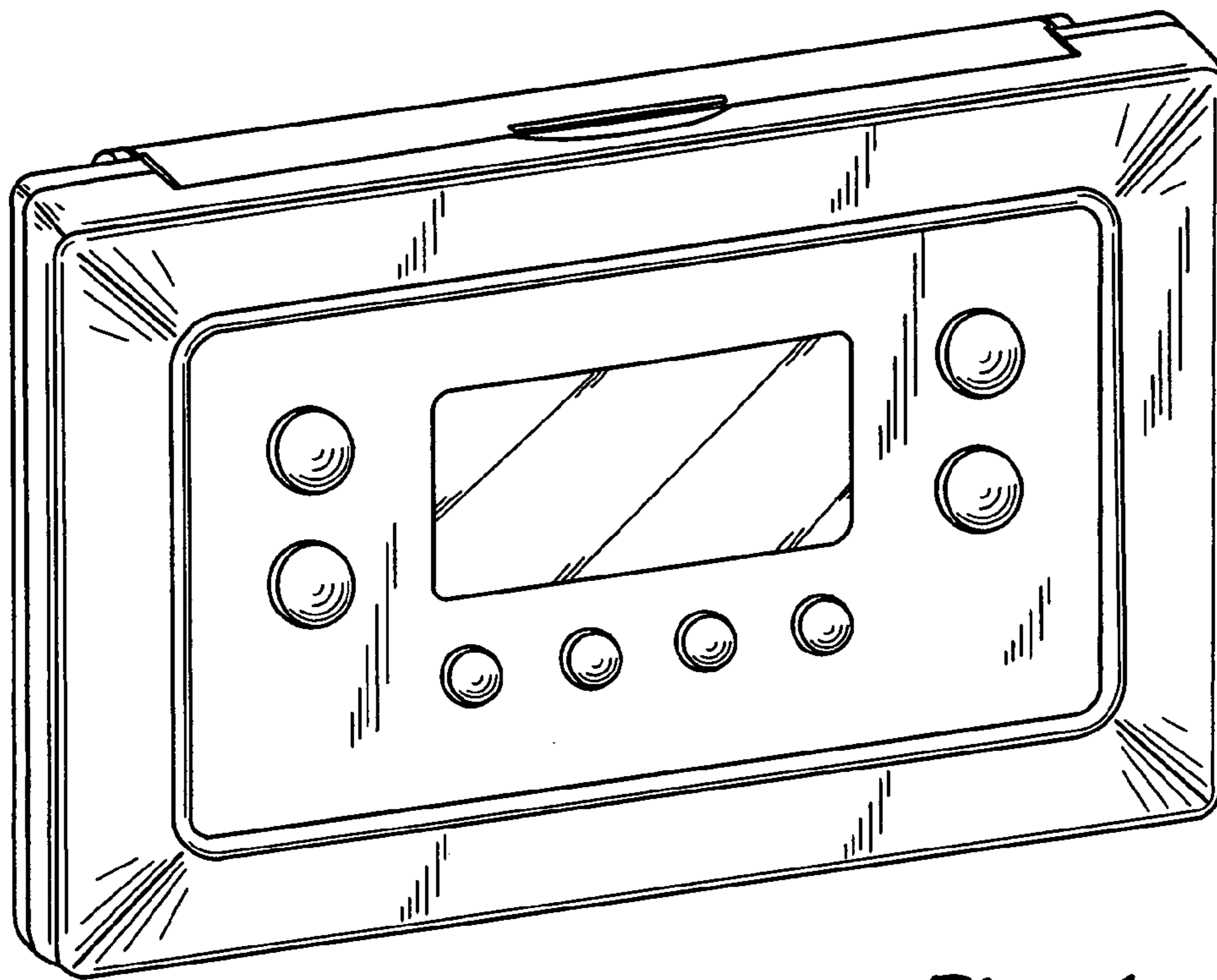

Fig. 1

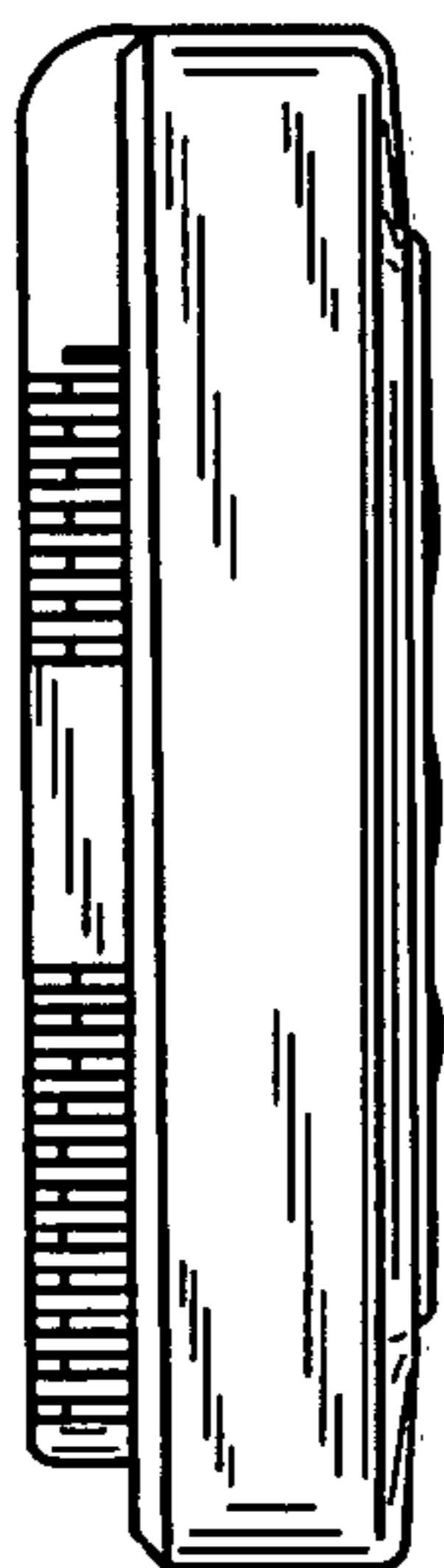

Fig. 2

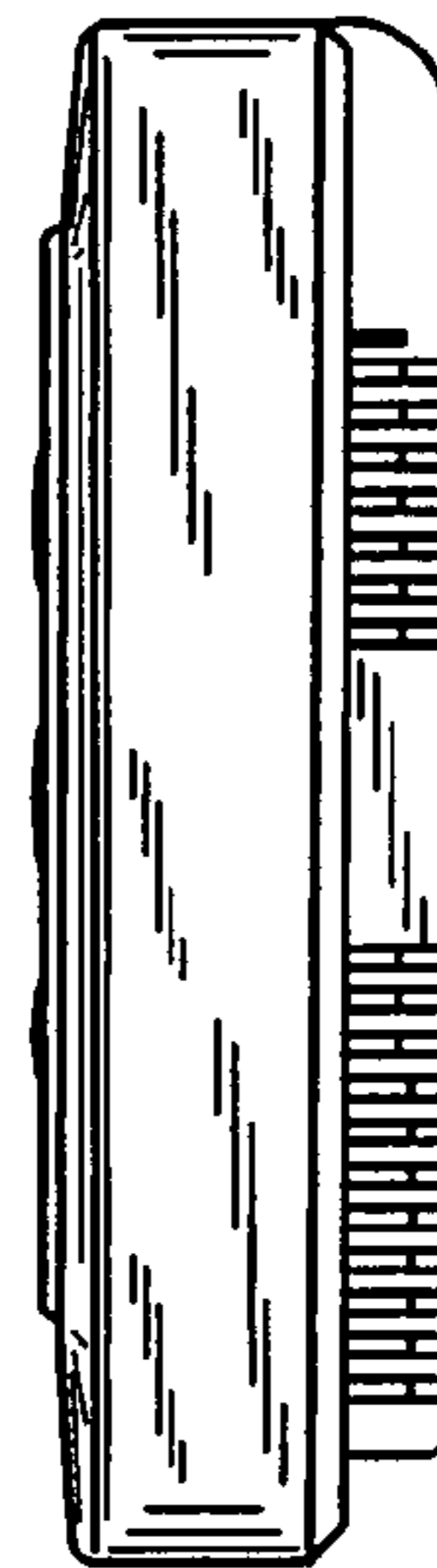

Fig. 3

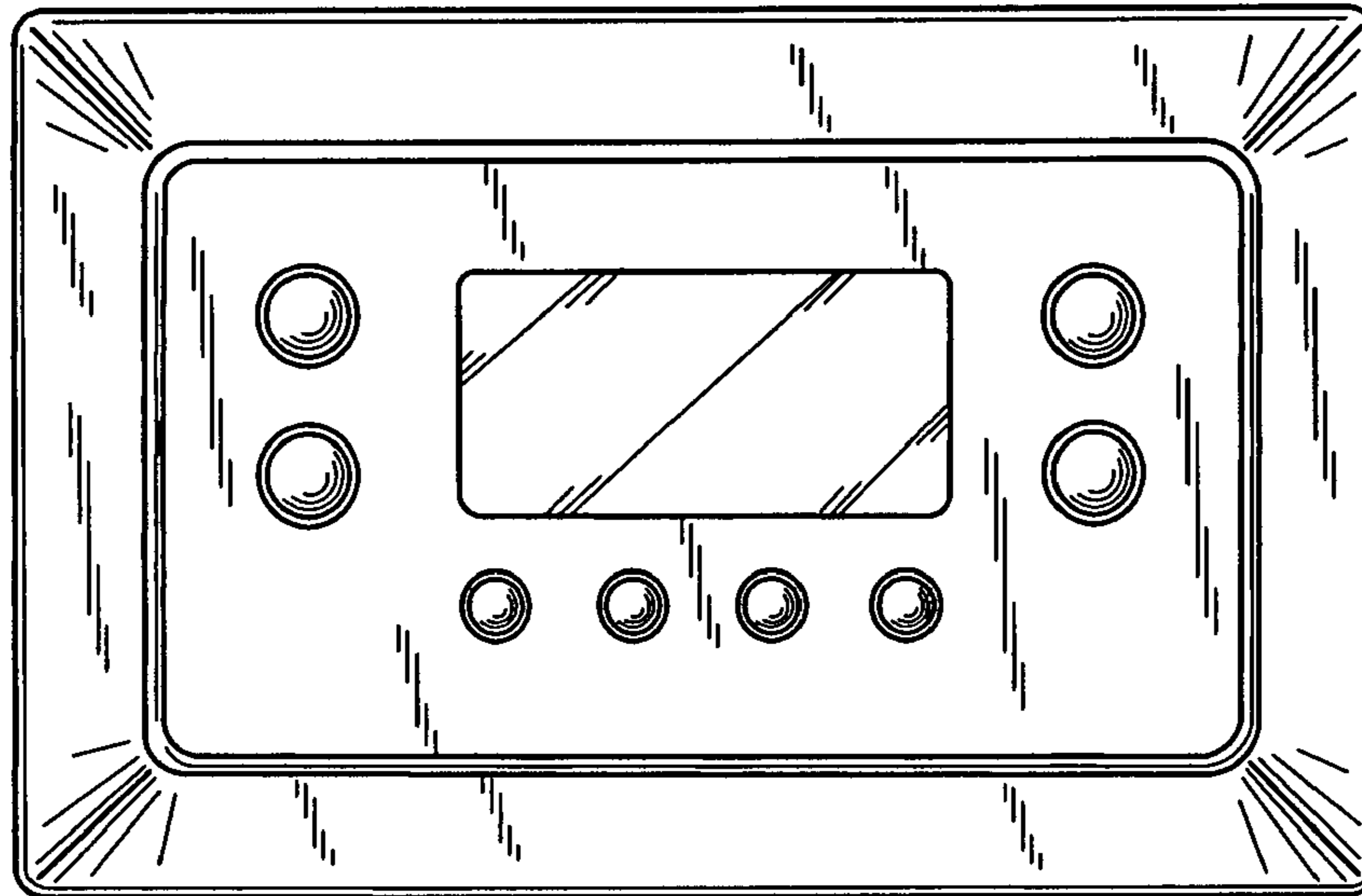

Fig. 4

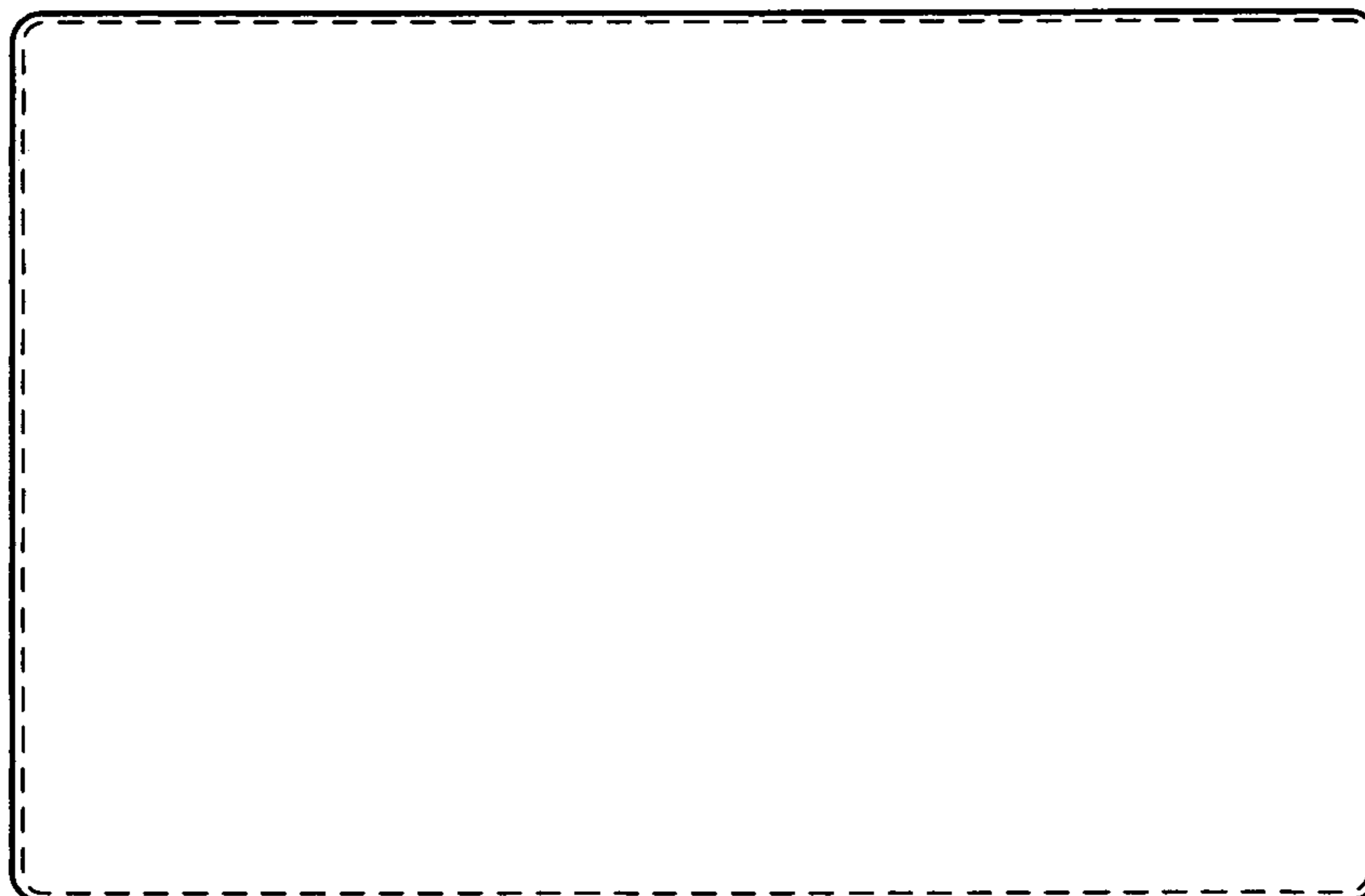

Fig. 5

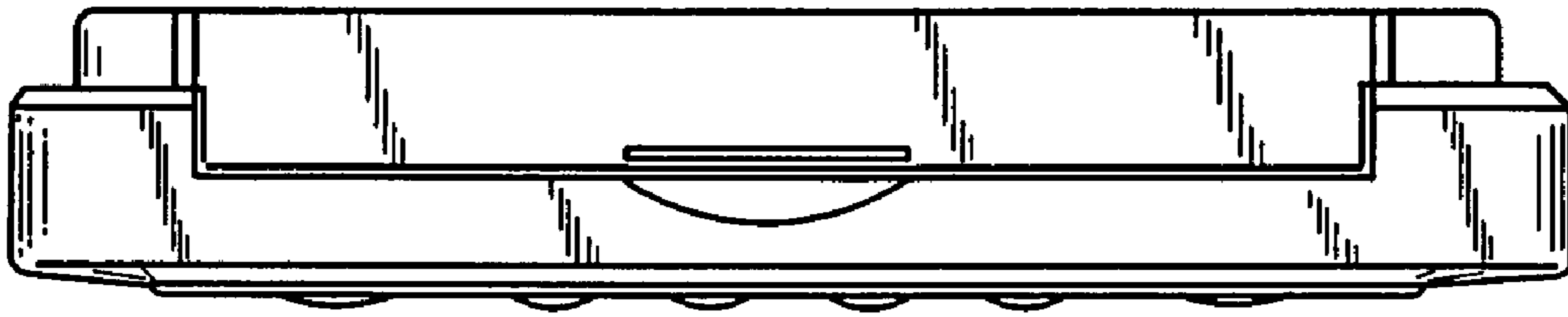

Fig. 6

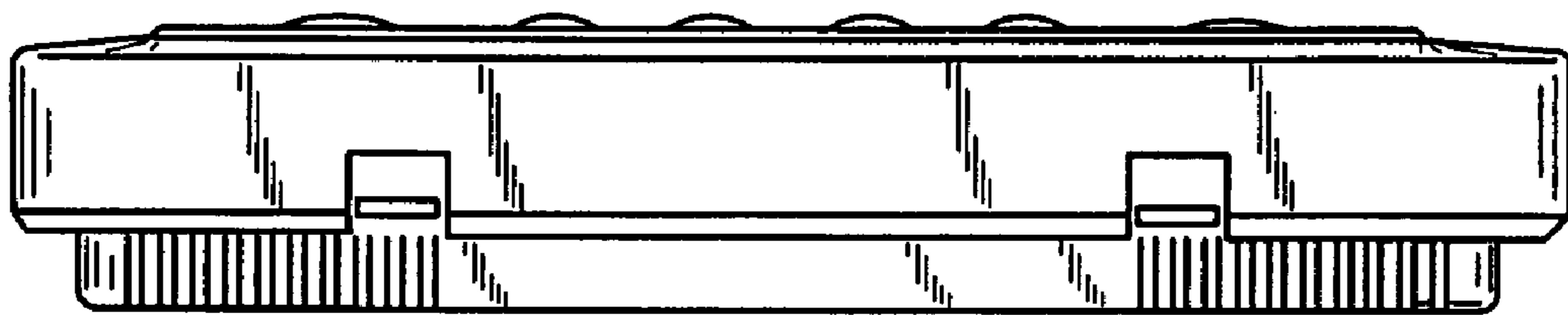

Fig. 7

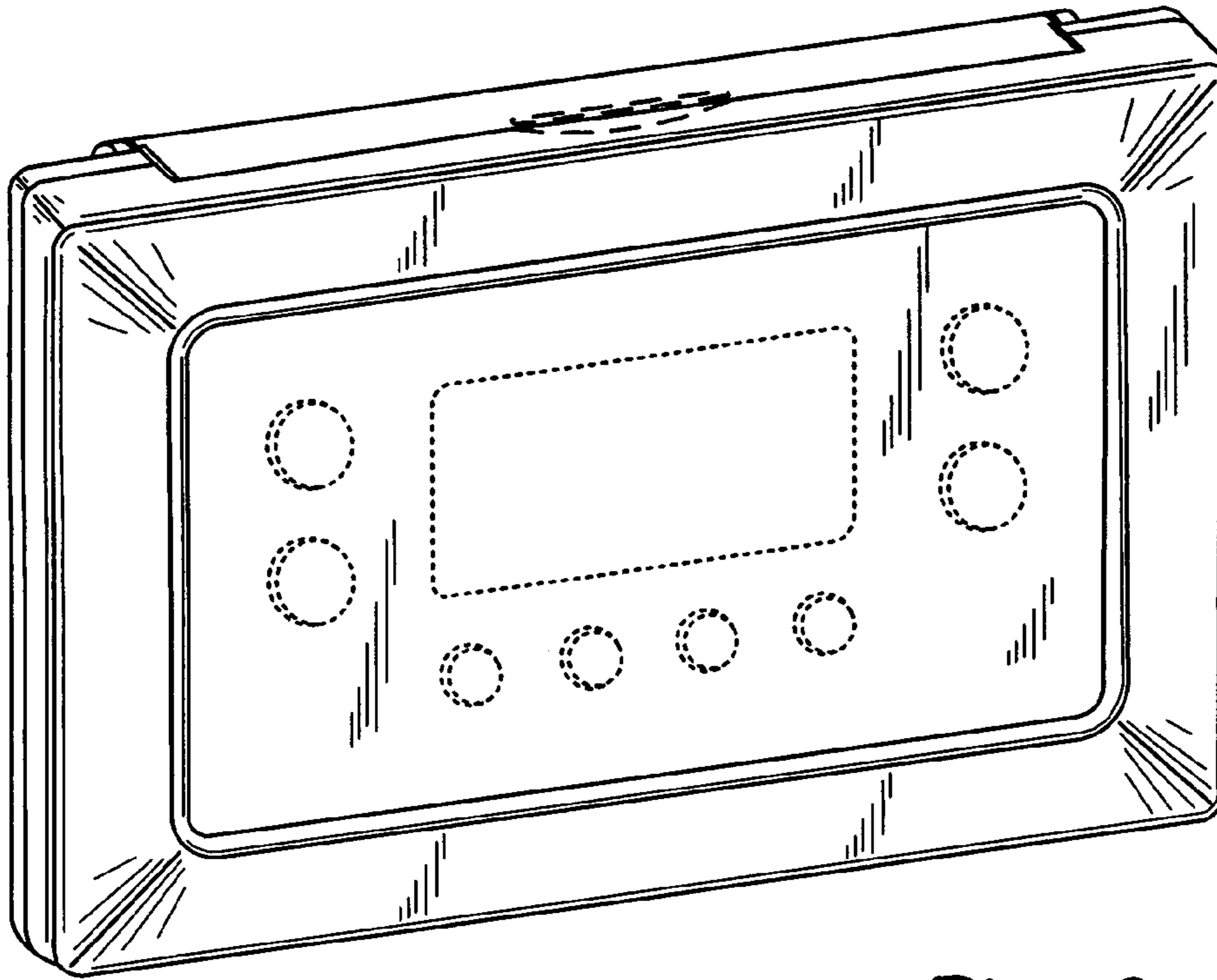

Fig. 8

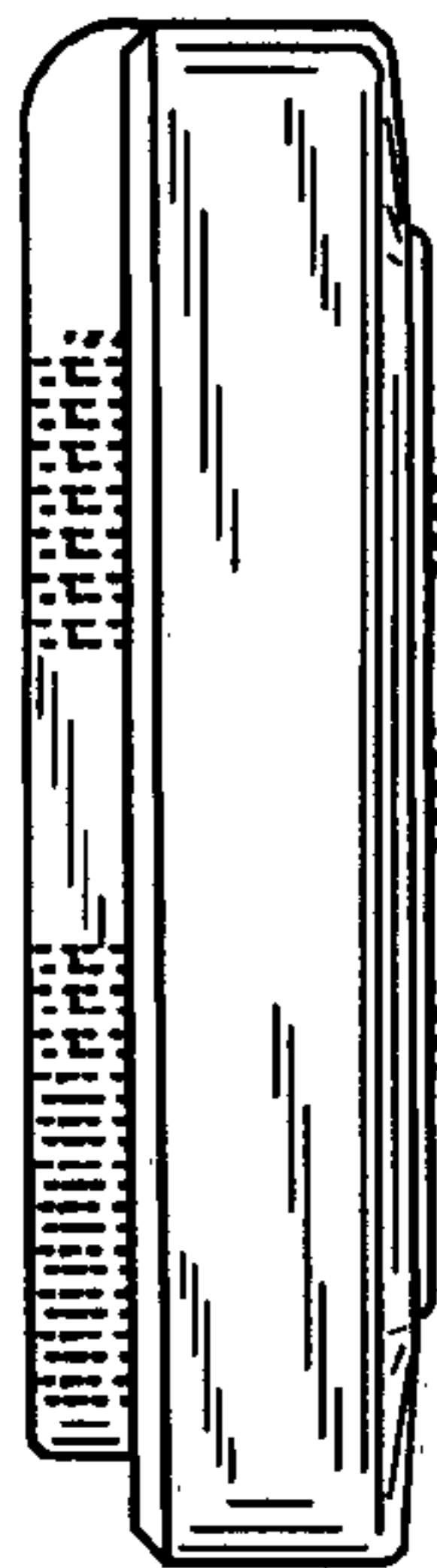

Fig. 9



Fig. 10

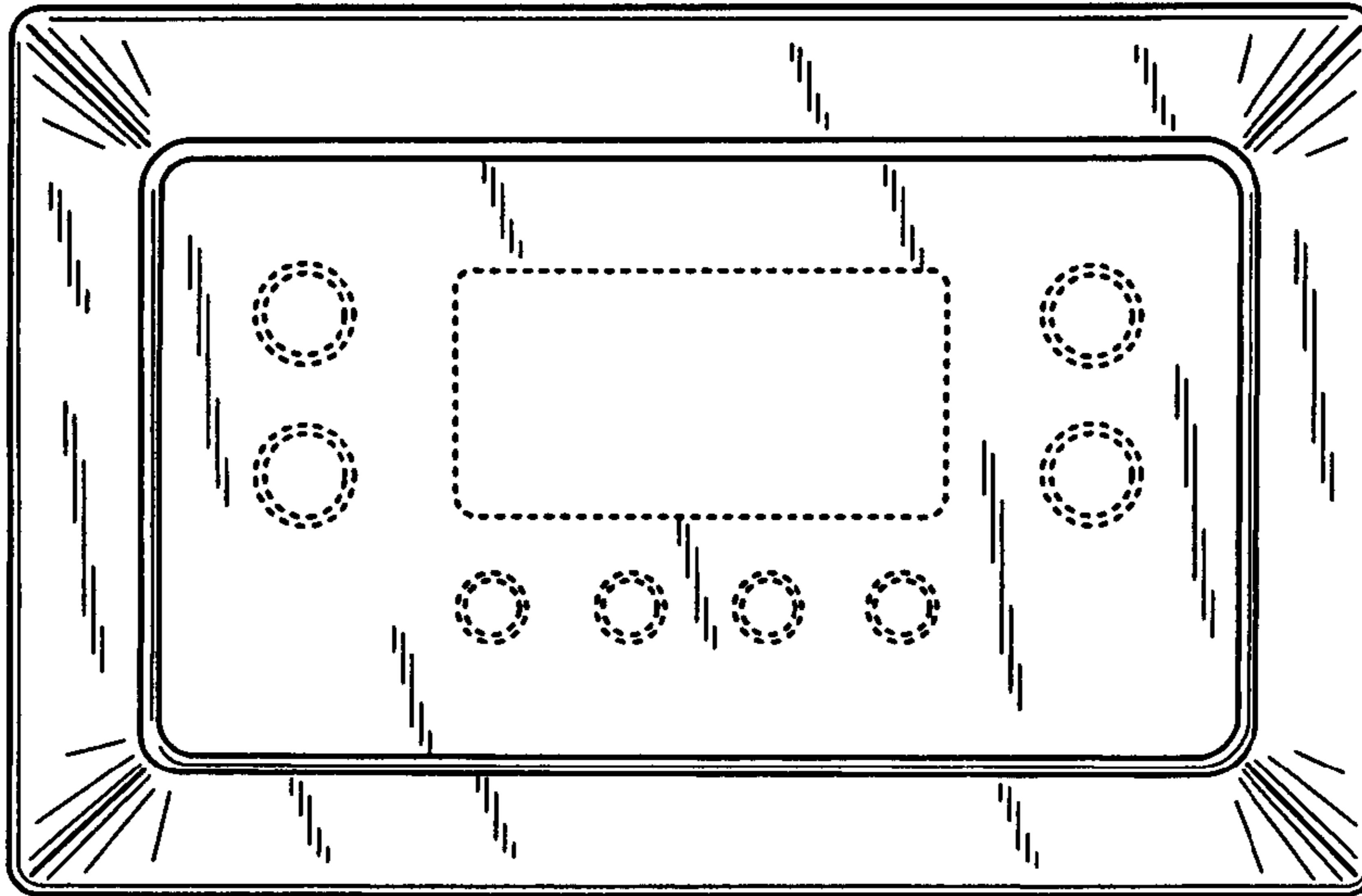

Fig. 11



Fig. 12

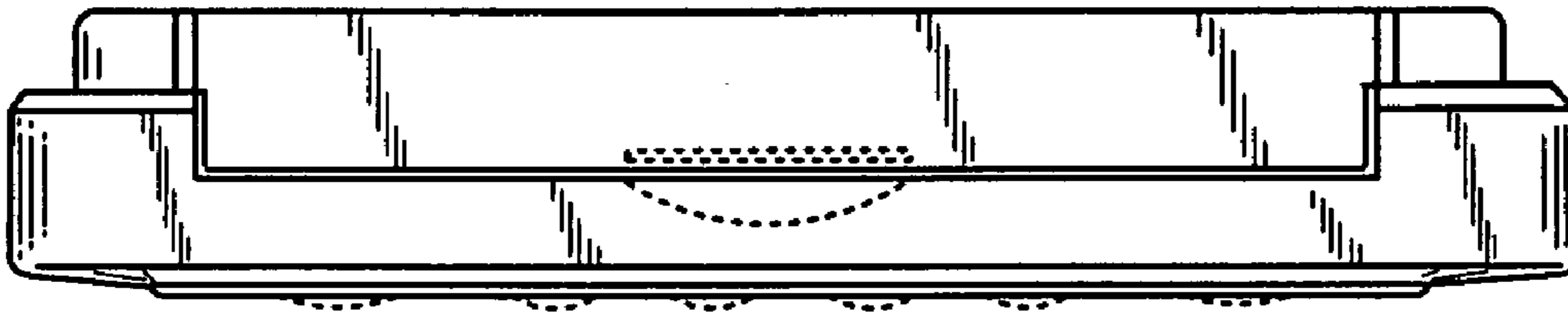

Fig. 13

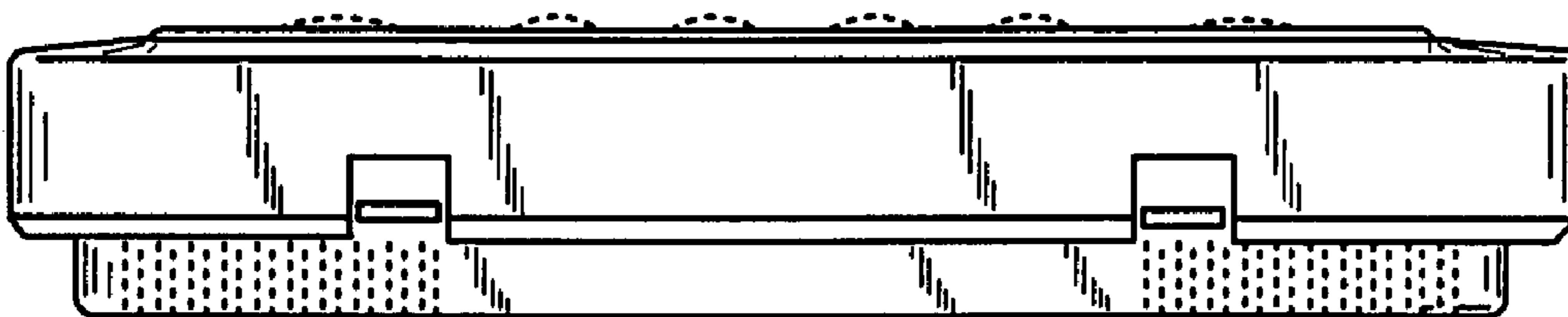

Fig. 14

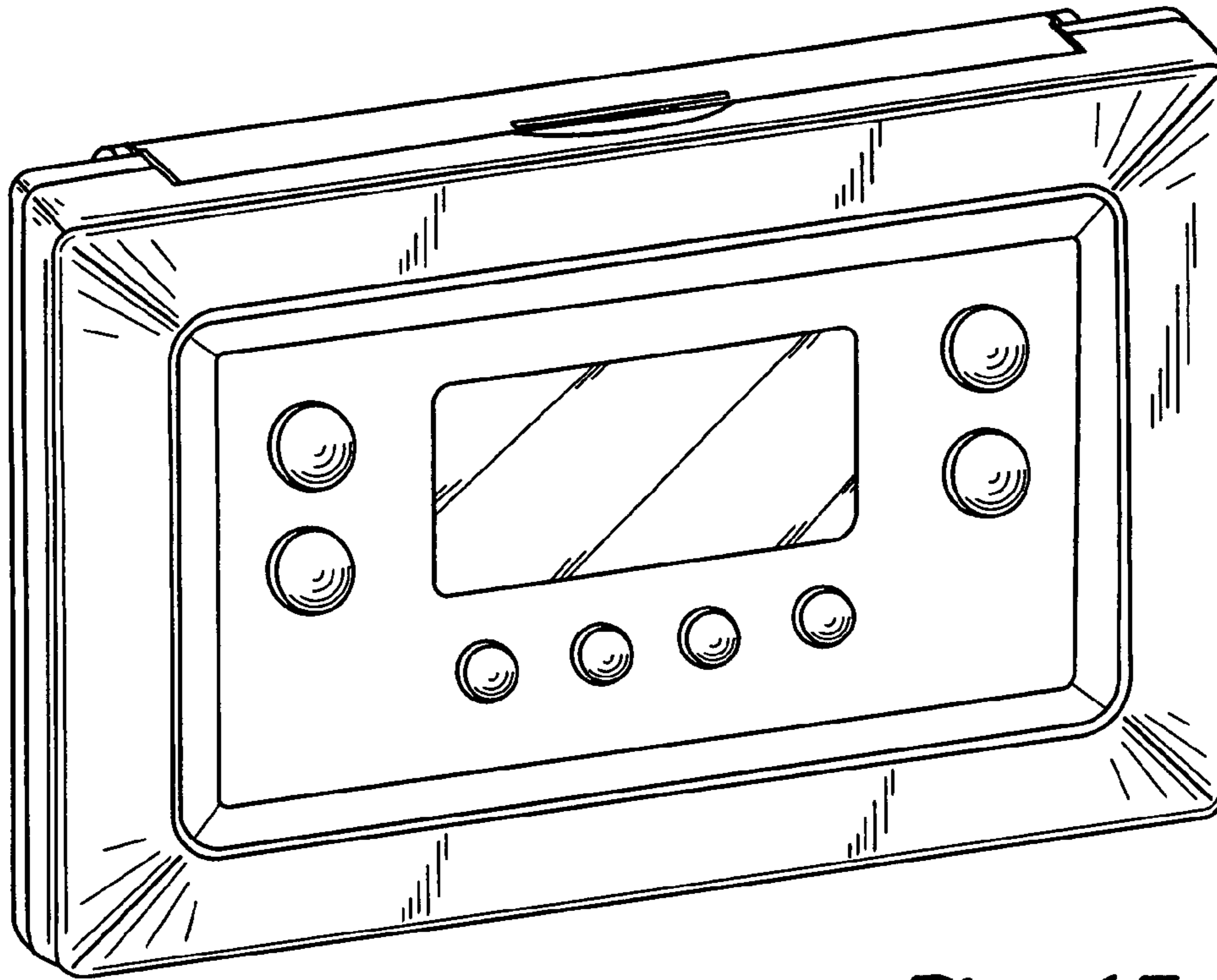

Fig. 15

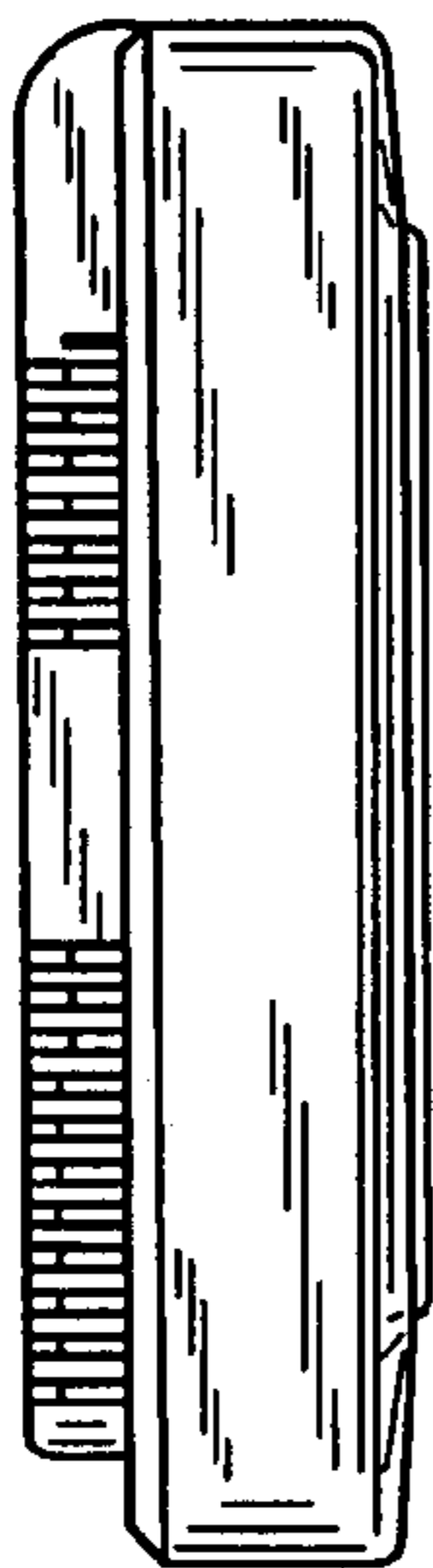

Fig. 16

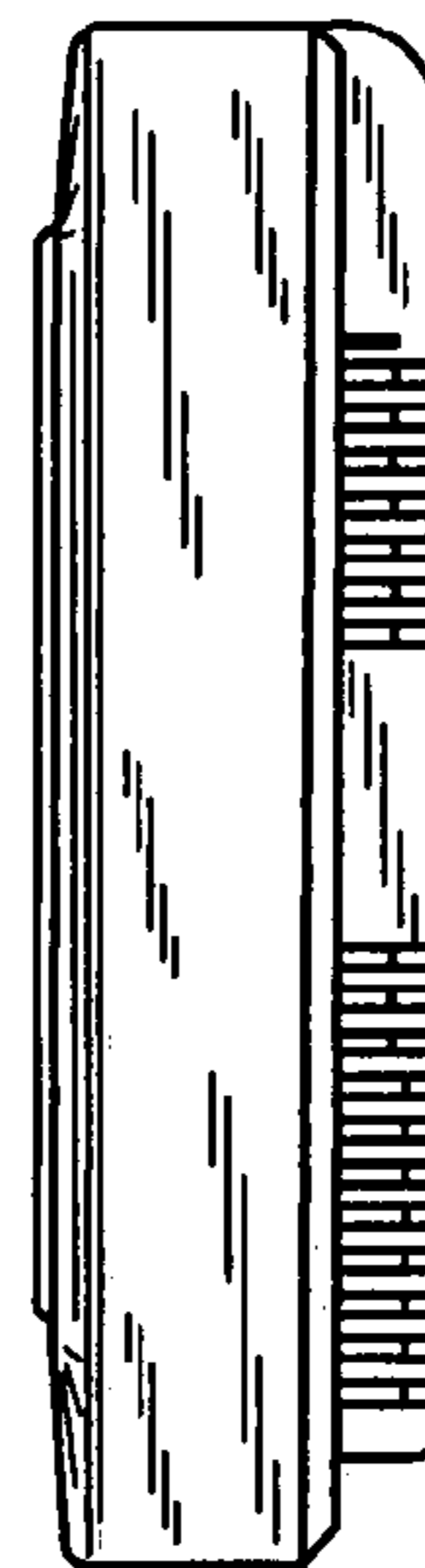

Fig. 17

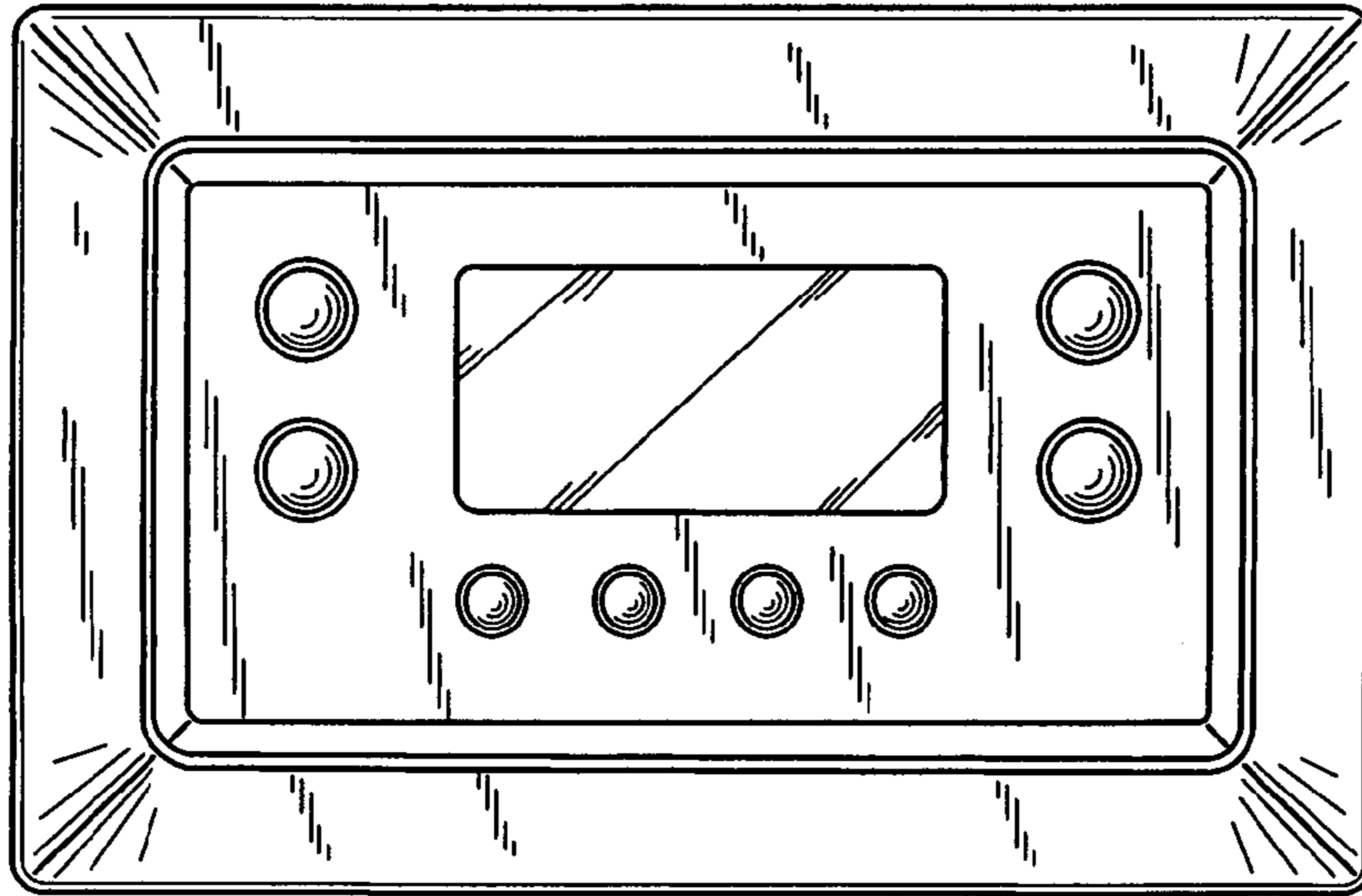

Fig. 18

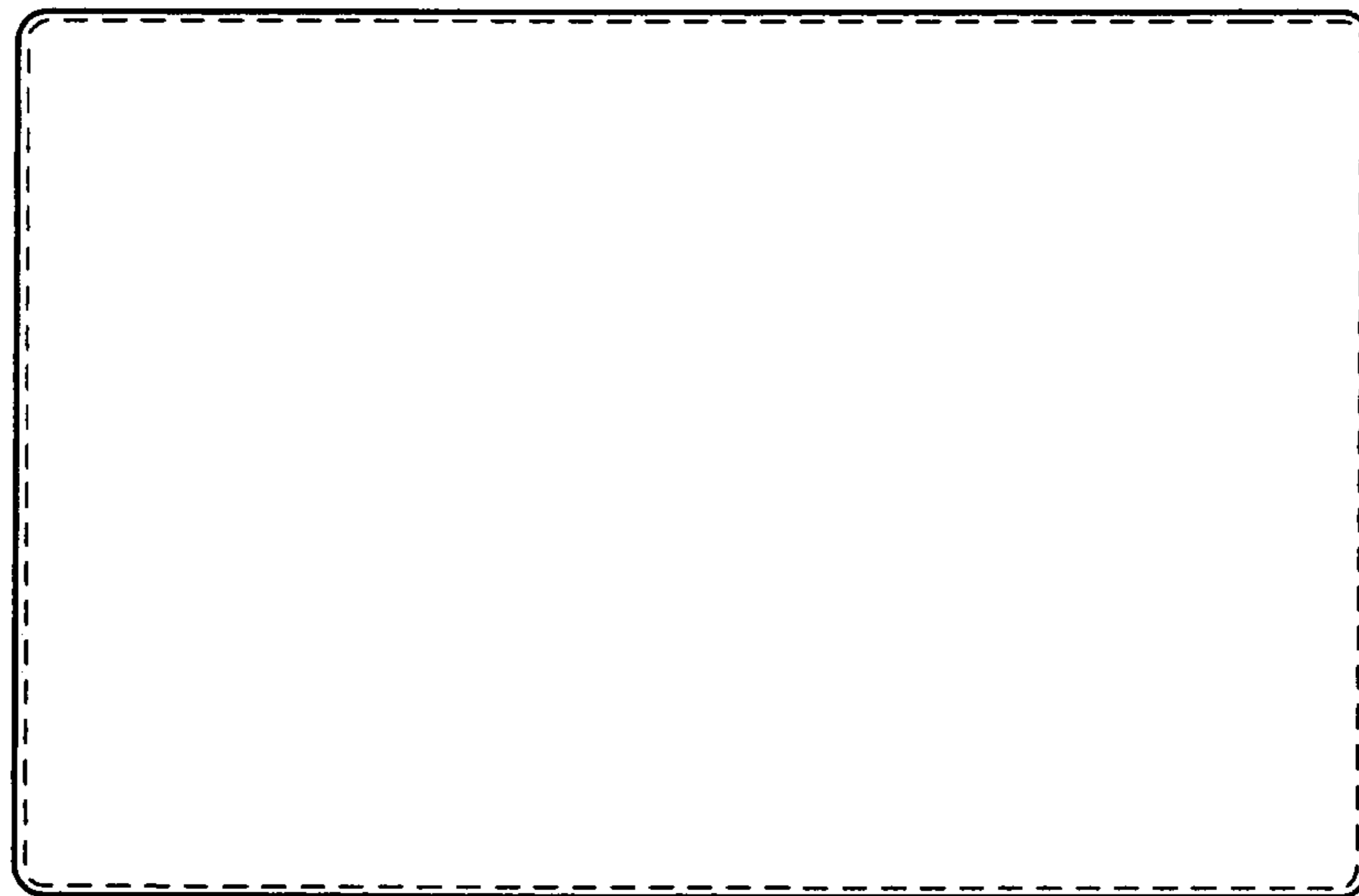

Fig. 19

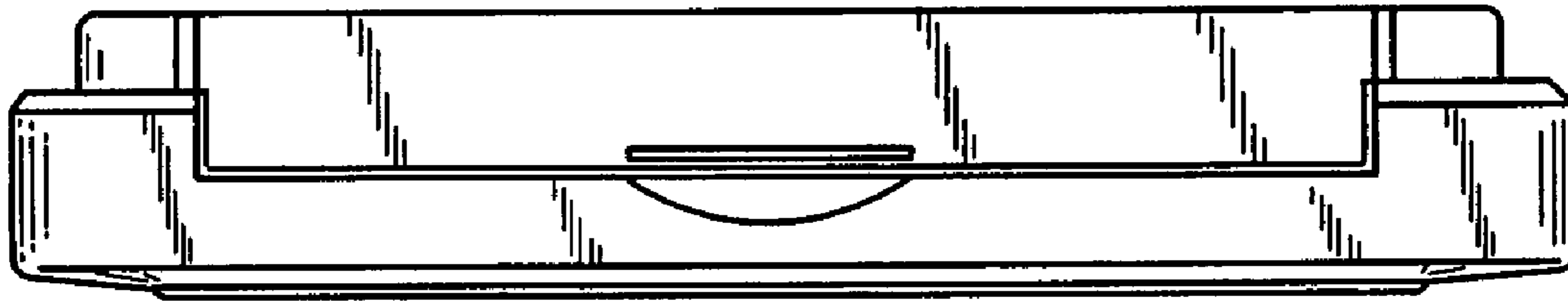

Fig. 20

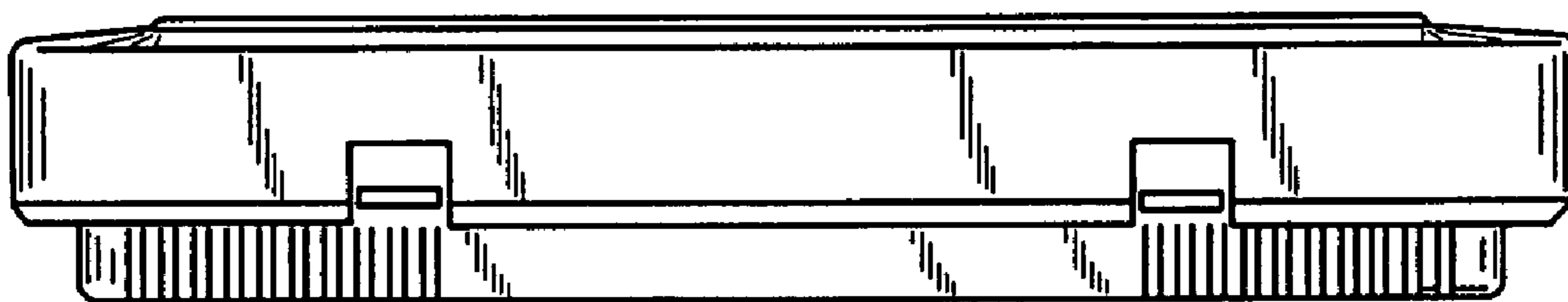

Fig. 21

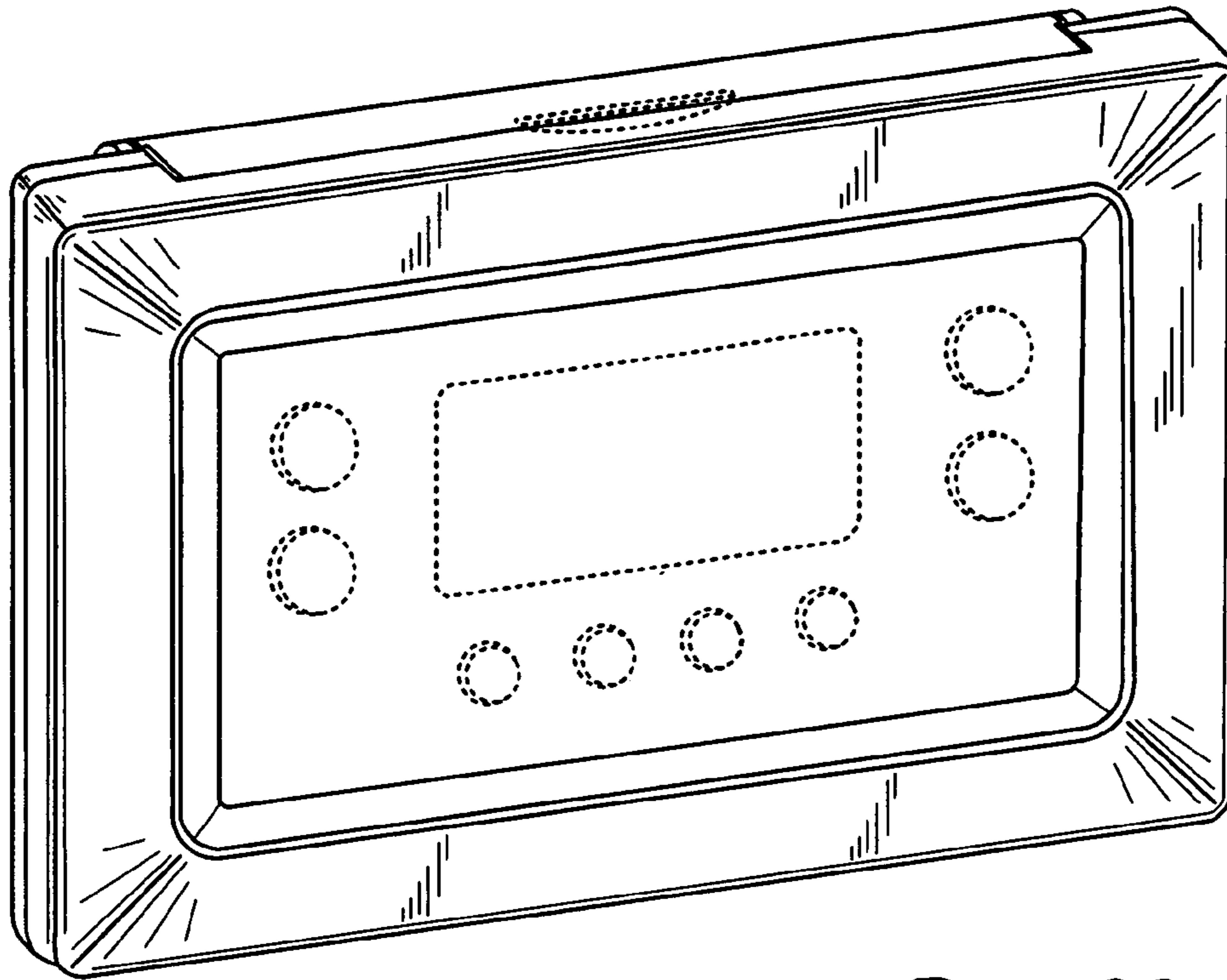

Fig. 22

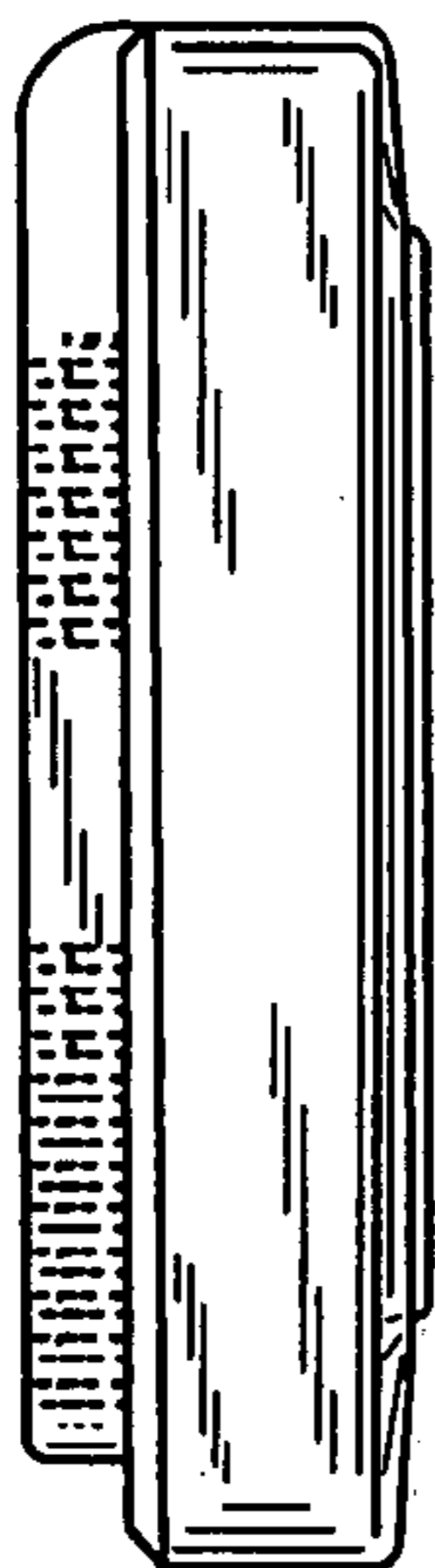

Fig. 23



Fig. 24

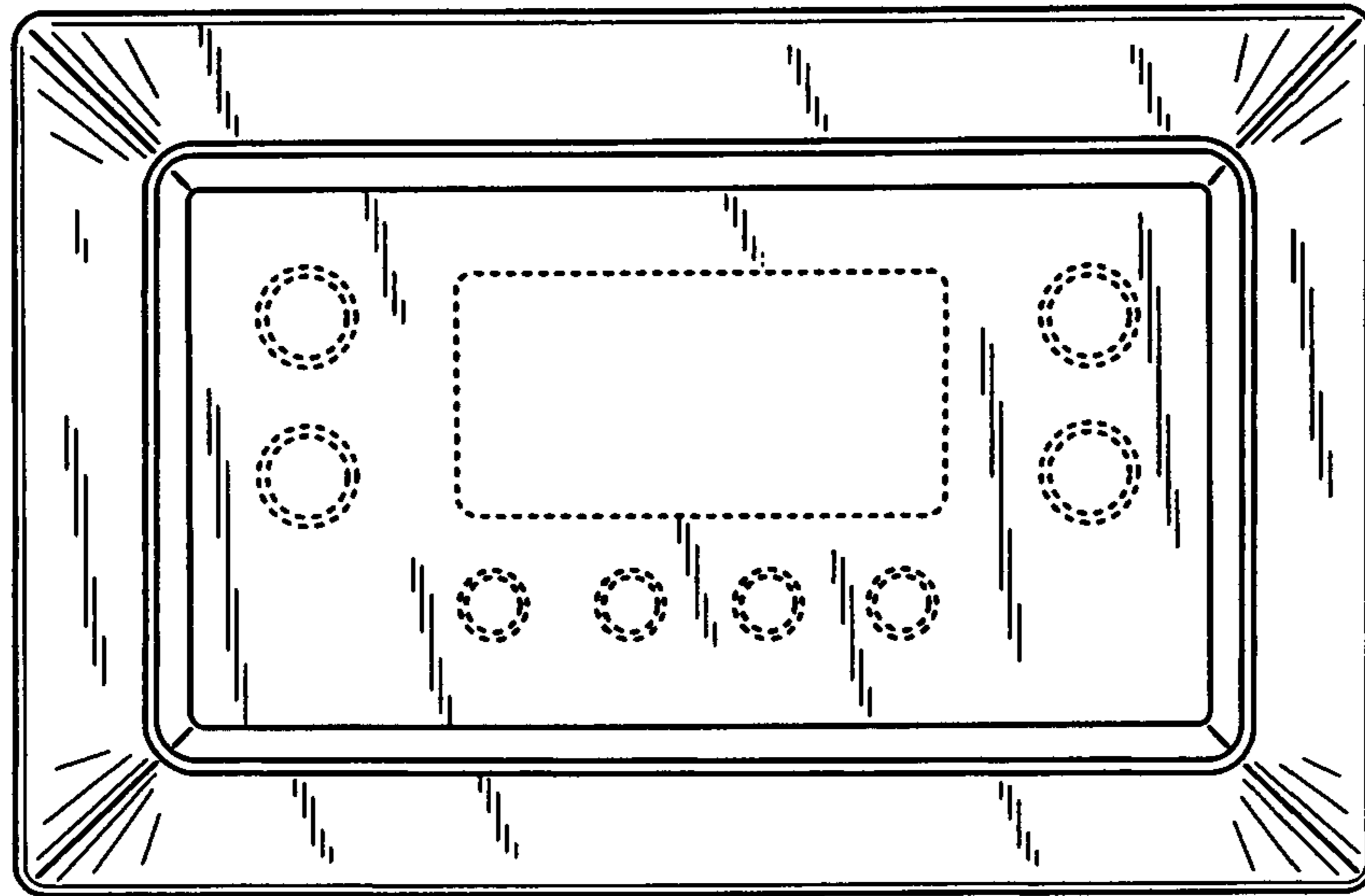

Fig. 25



Fig. 26

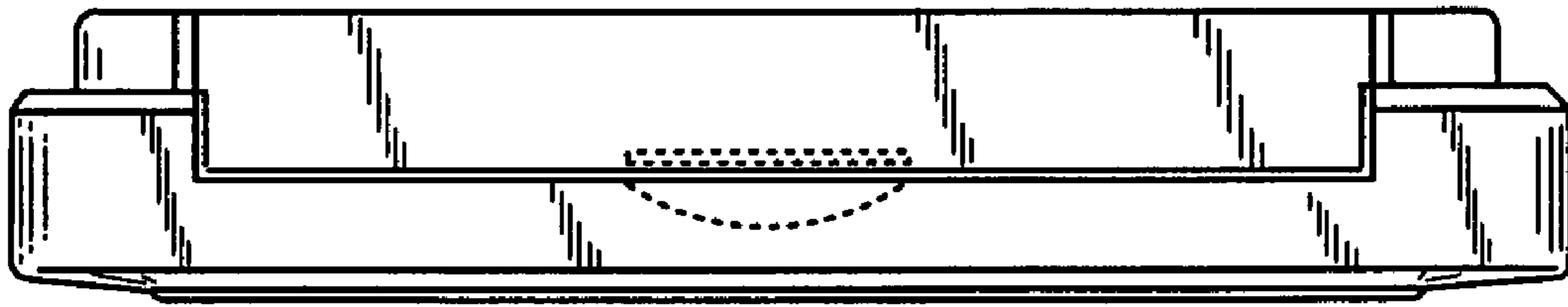

Fig. 27

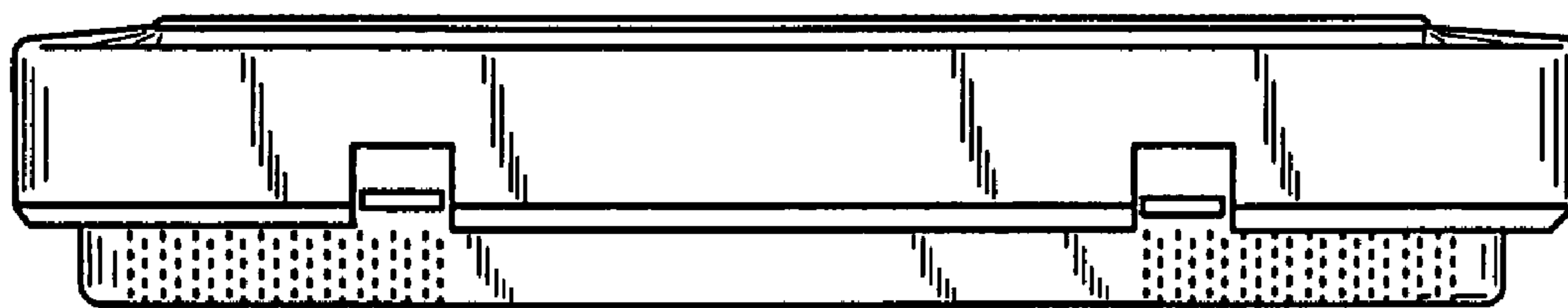

Fig. 28