



US00D577982S

(12) **United States Design Patent**
Thompson

(10) **Patent No.:** **US D577,982 S**

(45) **Date of Patent:** **** Oct. 7, 2008**

(54) **FURNITURE KNOB**

(75) **Inventor:** **David W. Thompson**, New Albany, OH (US)

(73) **Assignee:** **American Signature, Inc.**, Columbus, OH (US)

(**) **Term:** **14 Years**

(21) **Appl. No.:** **29/284,883**

(22) **Filed:** **Sep. 17, 2007**

(51) **LOC (8) Cl.** **08-06**

(52) **U.S. Cl.** **D8/301; D8/305**

(58) **Field of Classification Search** D8/310, D8/300, 306, 307, 319, 320, 350, 352, DIG. 2; D7/393; D23/254; 16/402, 412, 441, 110.1; 292/336.3, 337, 347, 357, 356
See application file for complete search history.

(56) **References Cited**

U.S. PATENT DOCUMENTS

D6,956 S *	10/1873	Hollis	D8/310
D8,491 S *	7/1875	Young	D8/310
D176,713 S *	1/1956	Ellis	D8/310
2,976,073 A *	3/1961	Russell et al.	292/352
2,993,720 A *	7/1961	Russell	292/347
D200,095 S *	1/1965	Clayton	D8/310
D214,867 S *	8/1969	Holmes et al.	D8/310
D232,621 S *	9/1974	Zagaroli	D8/310
D248,445 S *	7/1978	Palm, Jr.	D8/310

D251,475 S *	4/1979	Clayton	D8/310
D263,554 S *	3/1982	Wasbrough et al.	D8/301
D454,049 S *	3/2002	LaPlume et al.	D8/301
D558,557 S *	1/2008	Jou	D8/310

* cited by examiner

Primary Examiner—Paula A Greene

(74) *Attorney, Agent, or Firm*—Wood, Herron & Evans, L.L.P.

(57) **CLAIM**

The ornamental design for a furniture knob, as shown and described.

DESCRIPTION

FIG. 1 is a perspective view of a furniture knob showing my new design.

FIG. 2 is a left side elevational view thereof.

FIG. 3 is front elevational view thereof.

FIG. 4 is a section view taken along line 4—4 of FIG. 3.

FIG. 5 is a rear view thereof.

FIG. 6 is a perspective view of a second embodiment of a furniture knob showing my new design.

FIG. 7 is a left side elevational view of FIG. 6.

FIG. 8 is a front elevational view of FIG. 6.

FIG. 9 is a sectional view taken along line 9—9 of FIG. 8; and,

FIG. 10 is a rear view of FIG. 6.

1 Claim, 6 Drawing Sheets

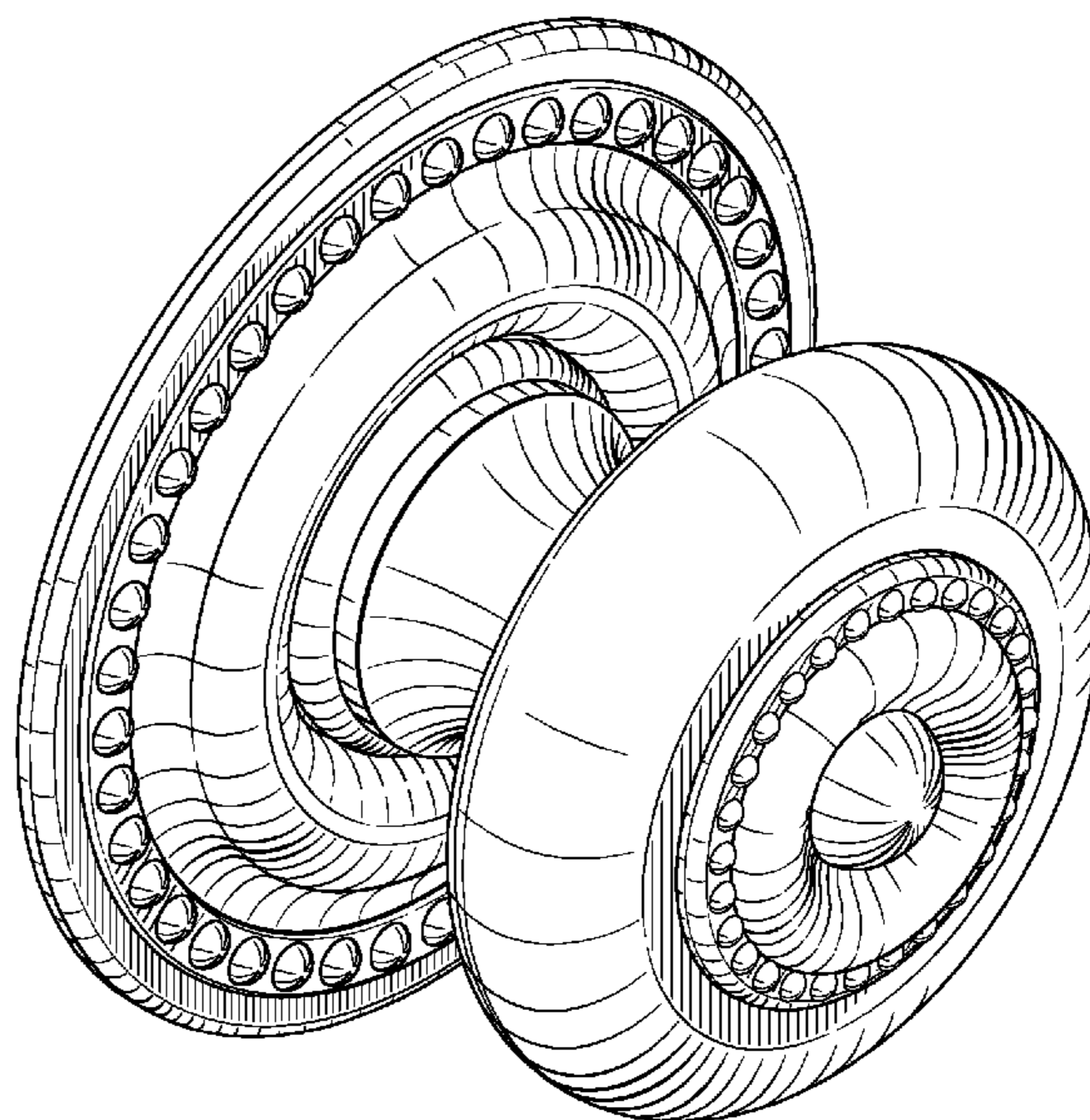
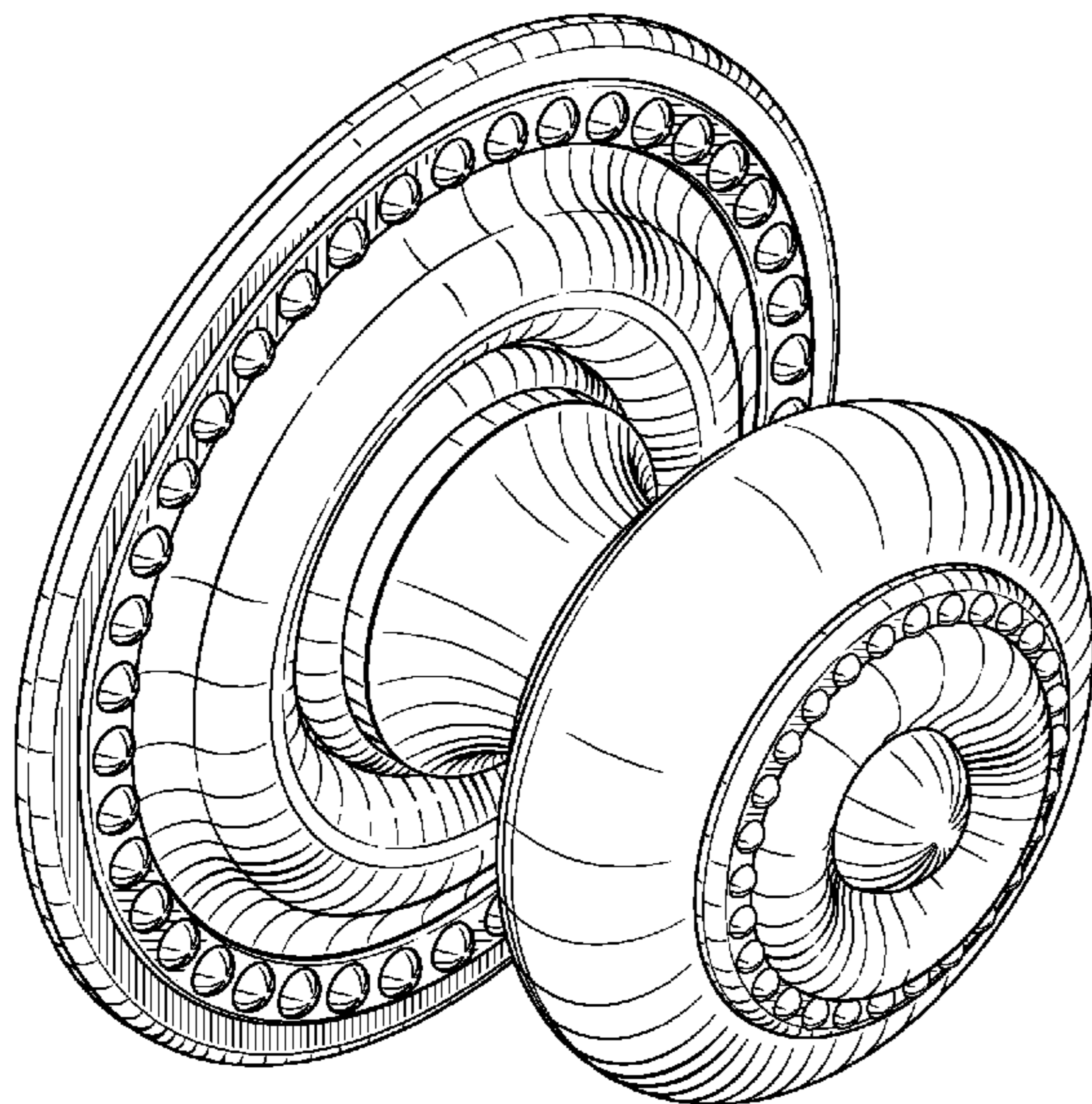

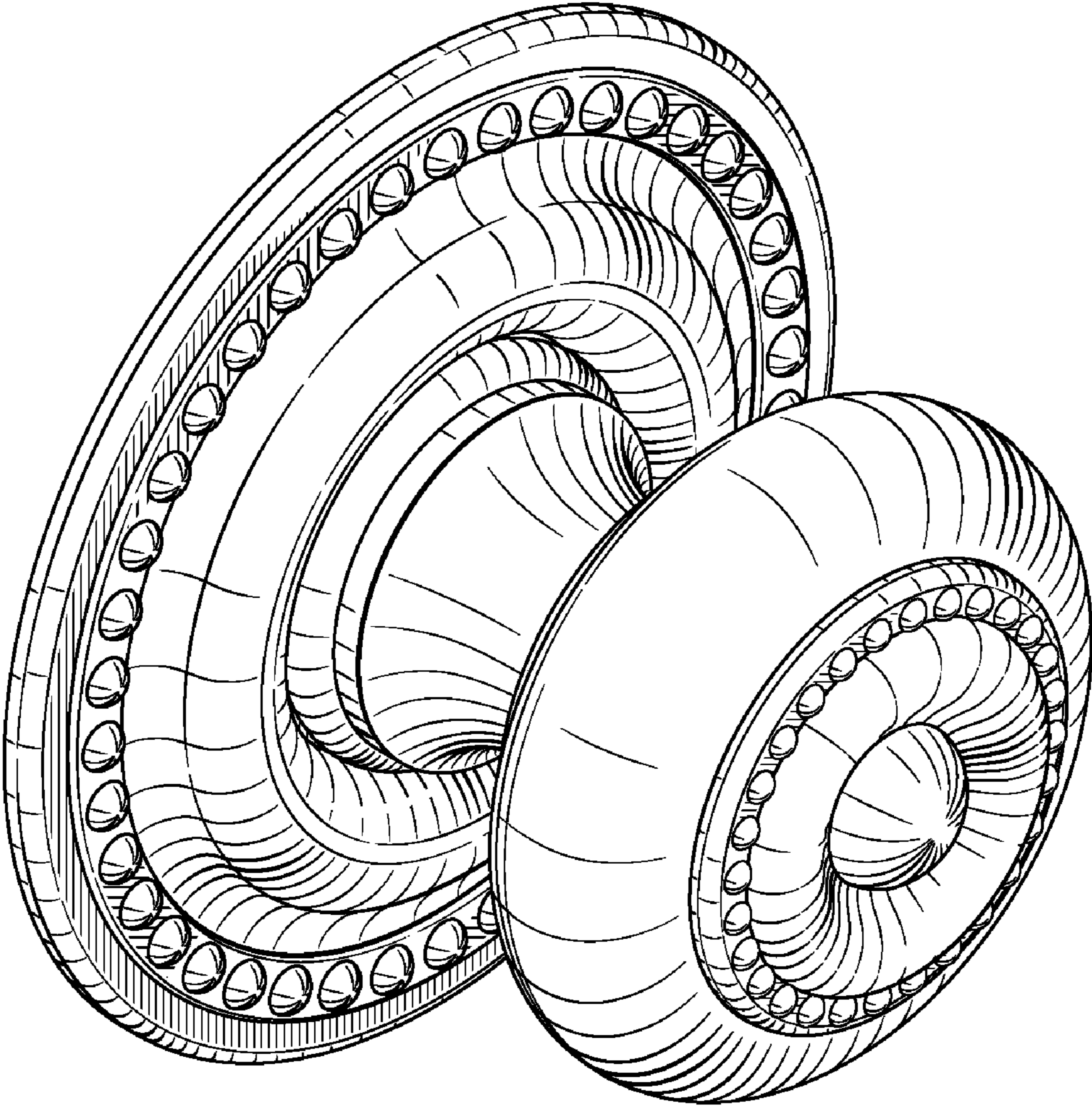

FIG. 1

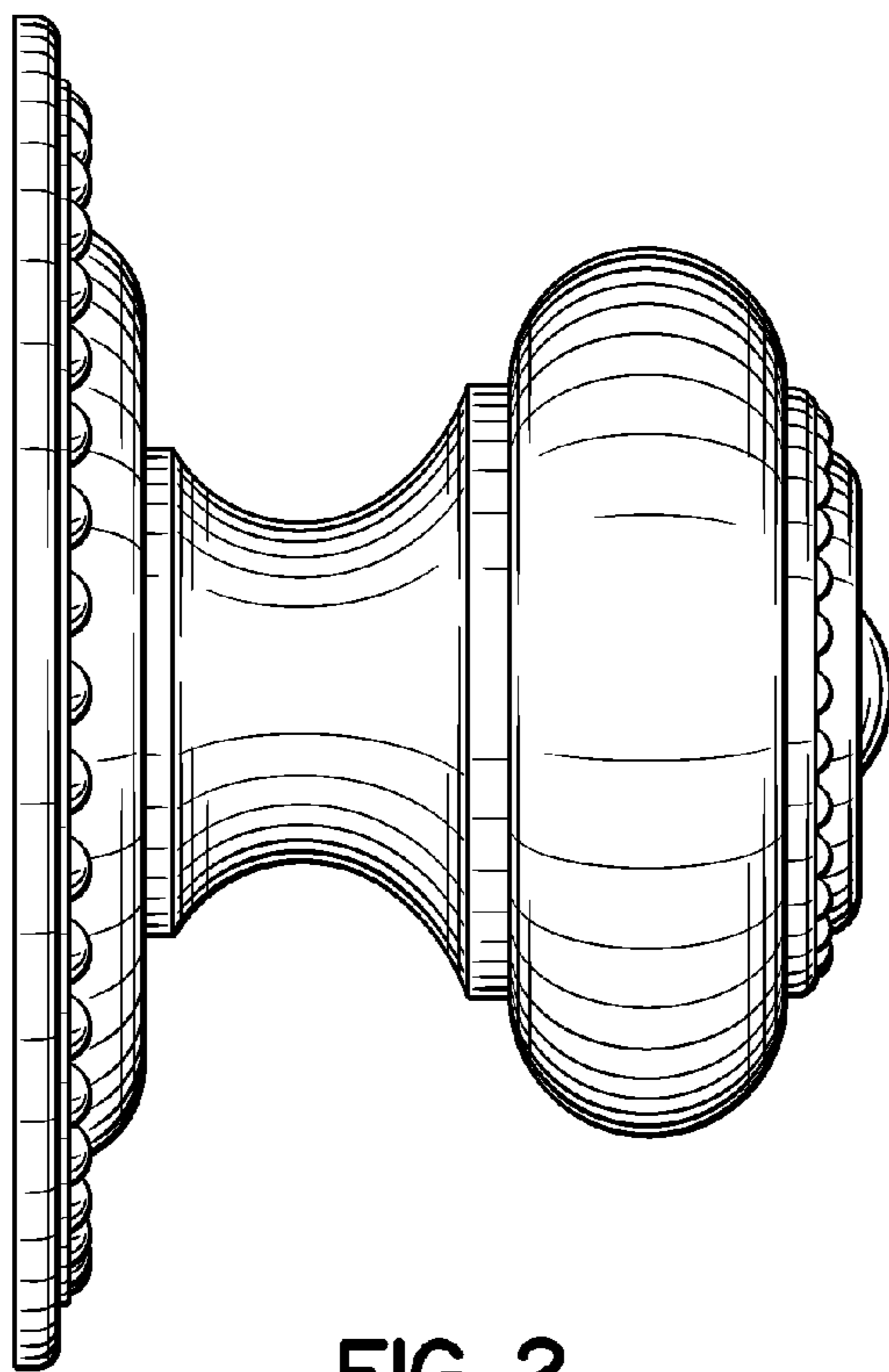

FIG. 2

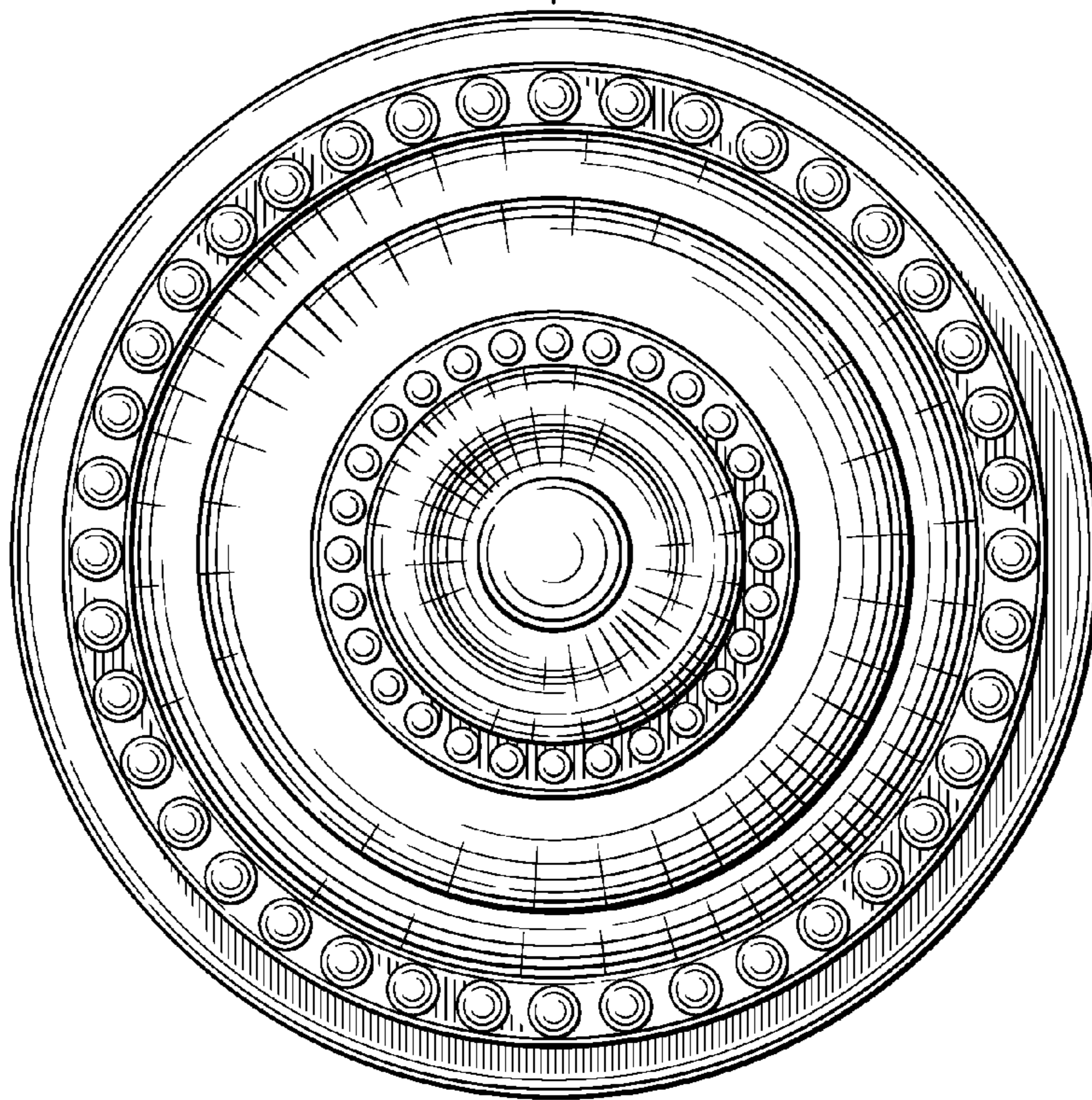
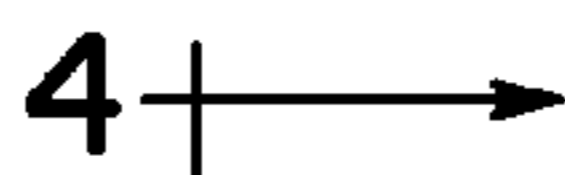

FIG. 3

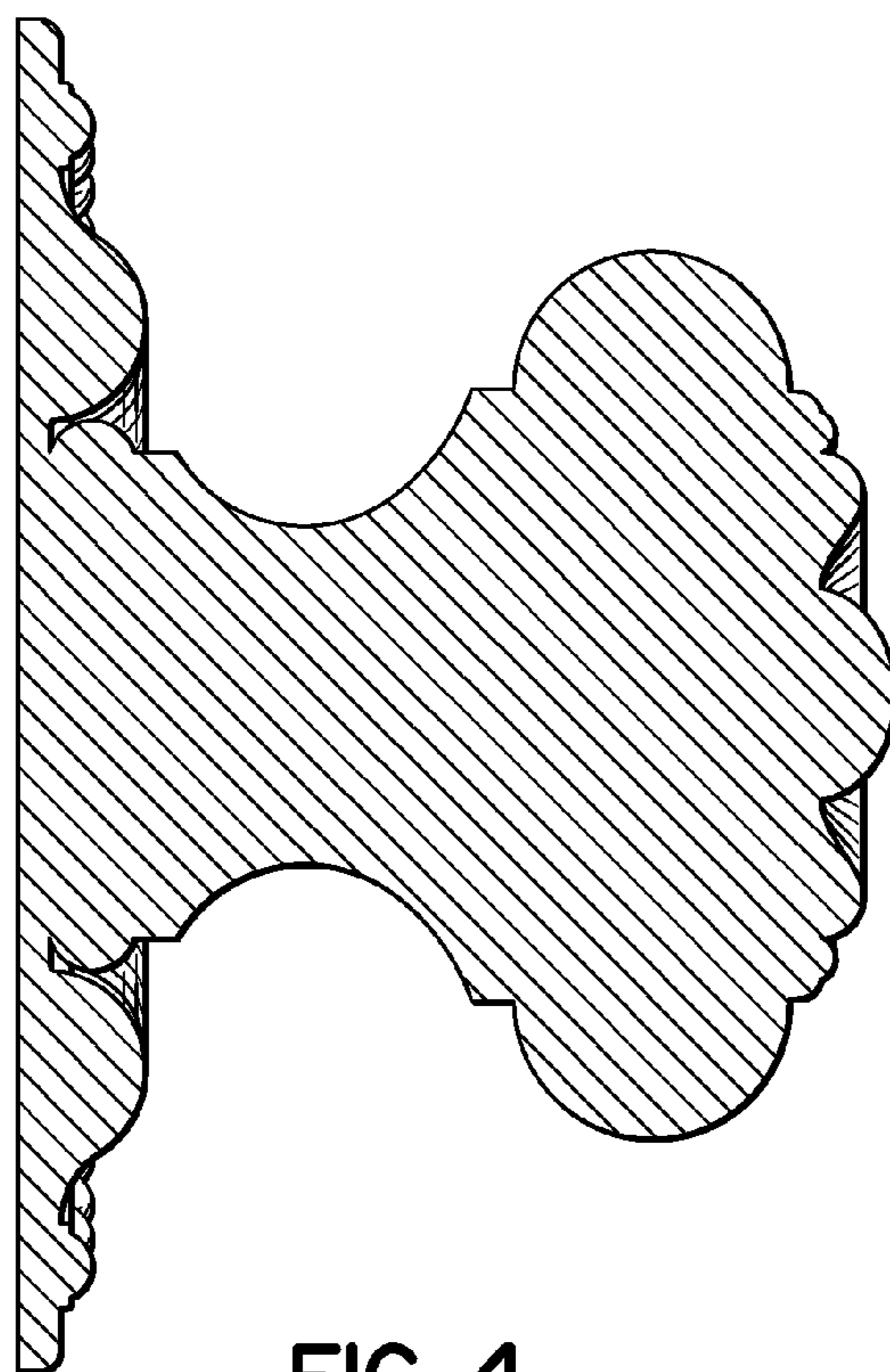

FIG. 4

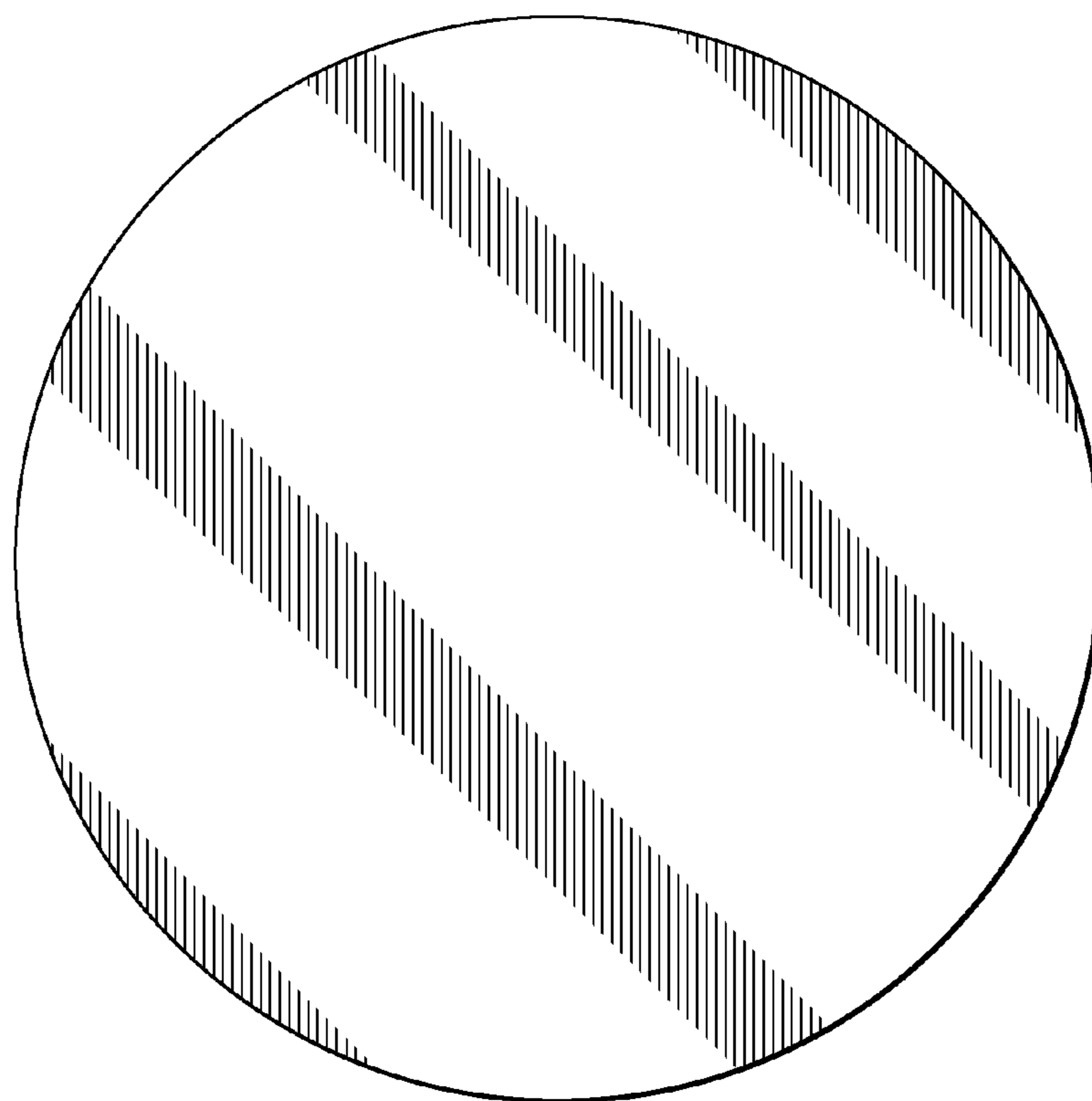

FIG. 5

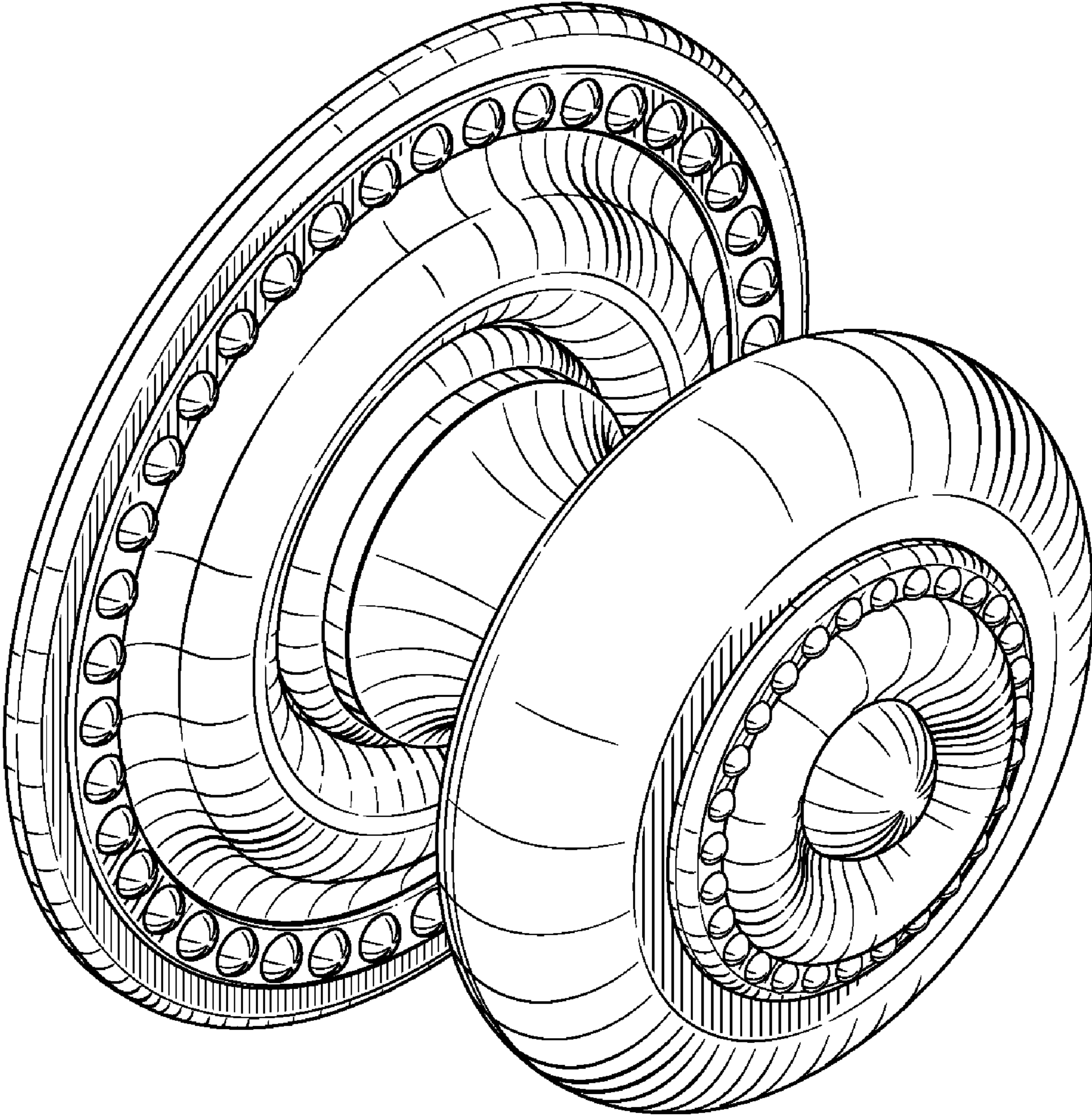

FIG. 6

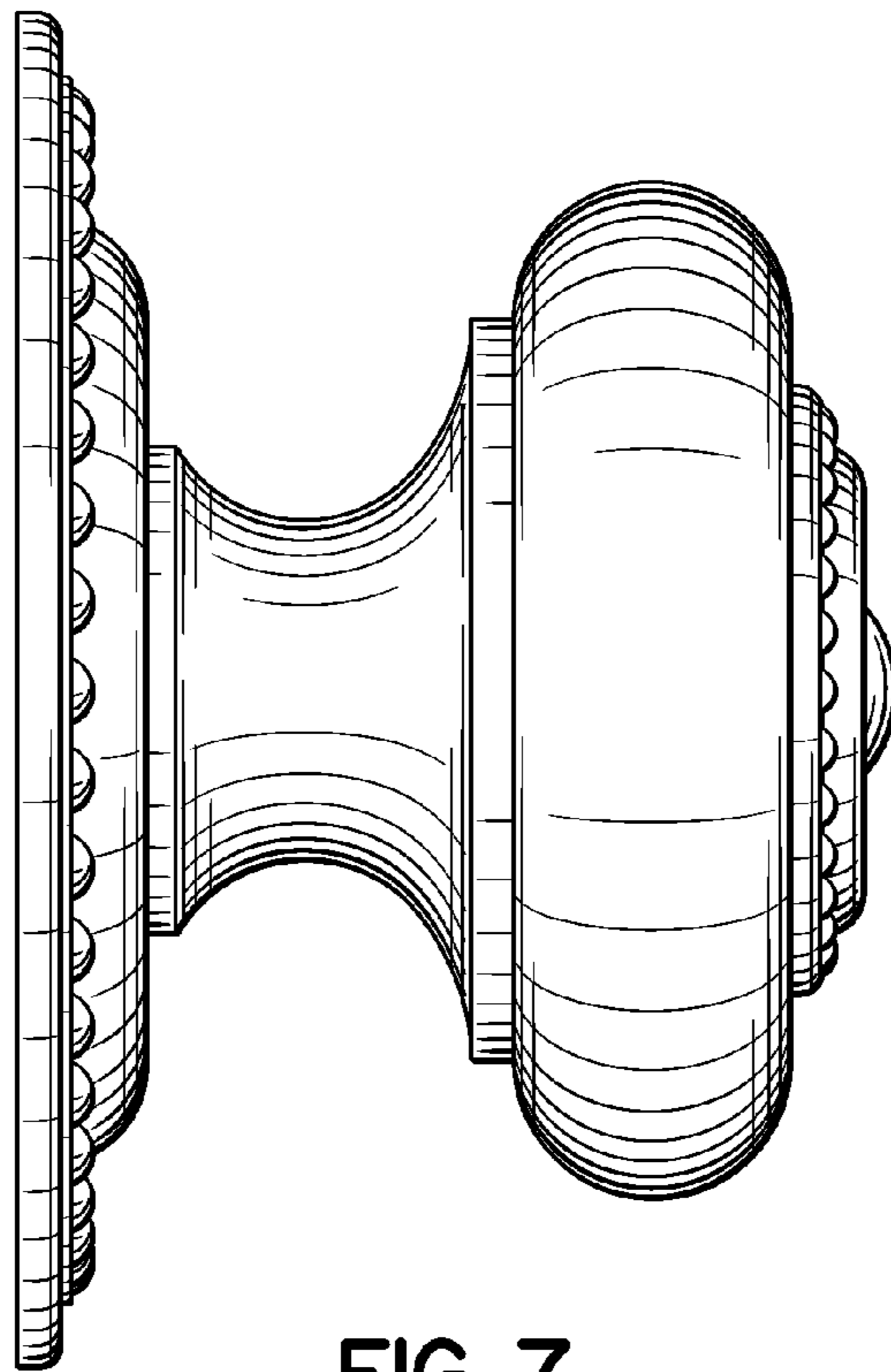

FIG. 7

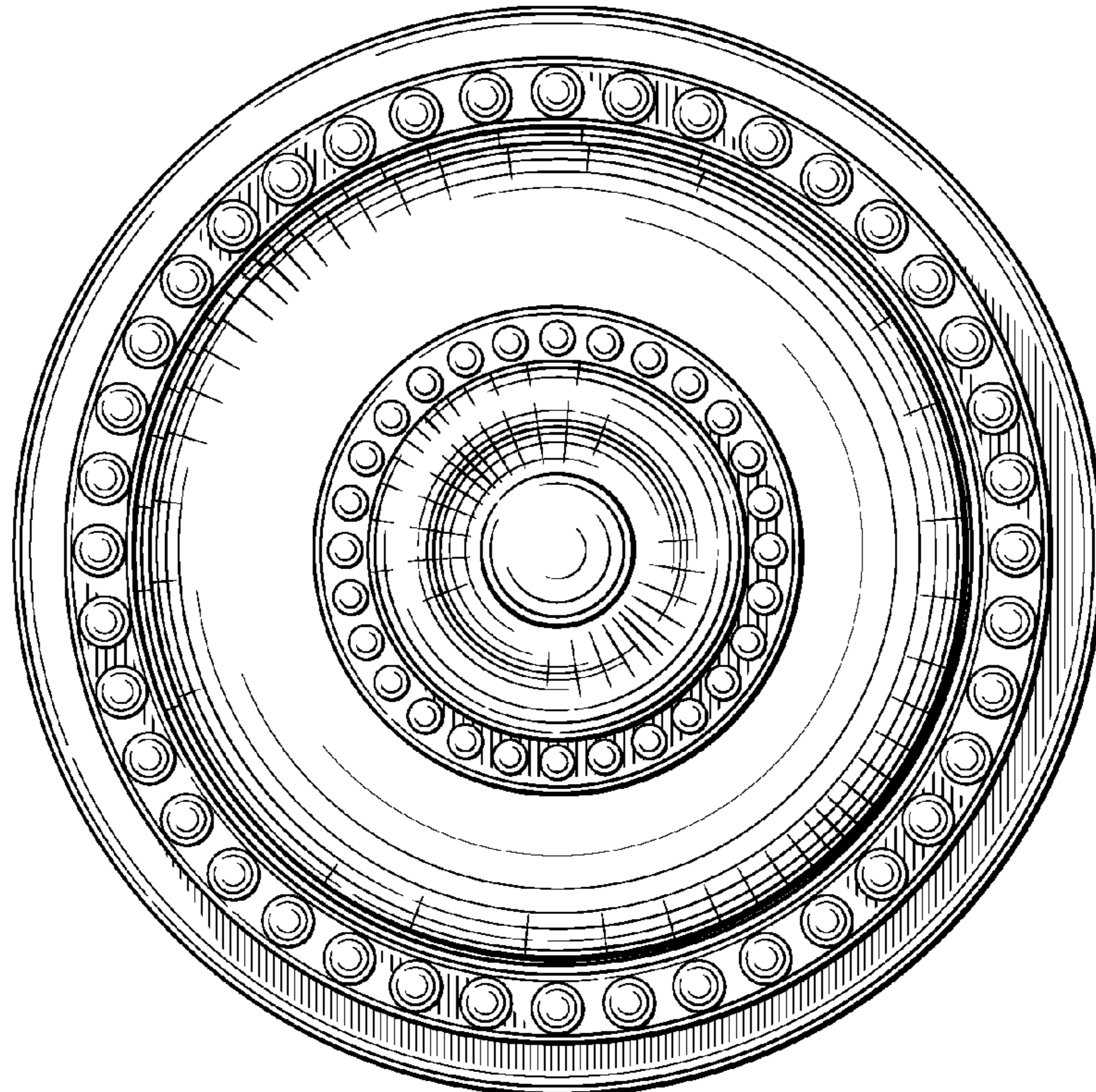
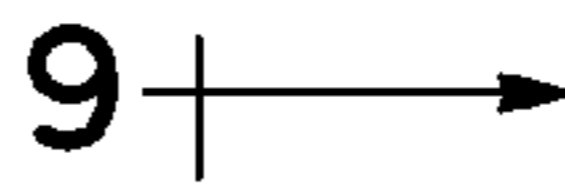

FIG. 8

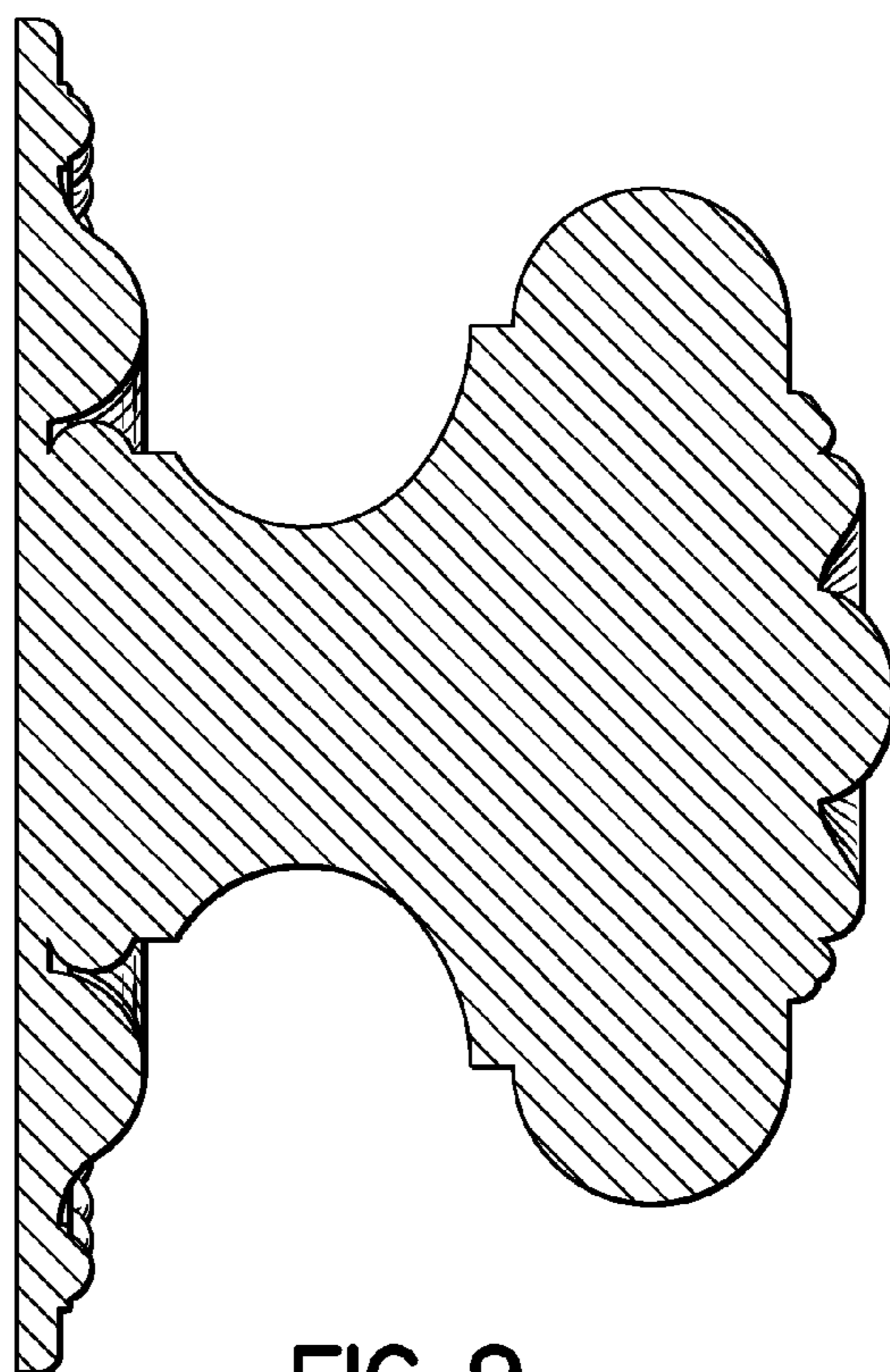

FIG. 9

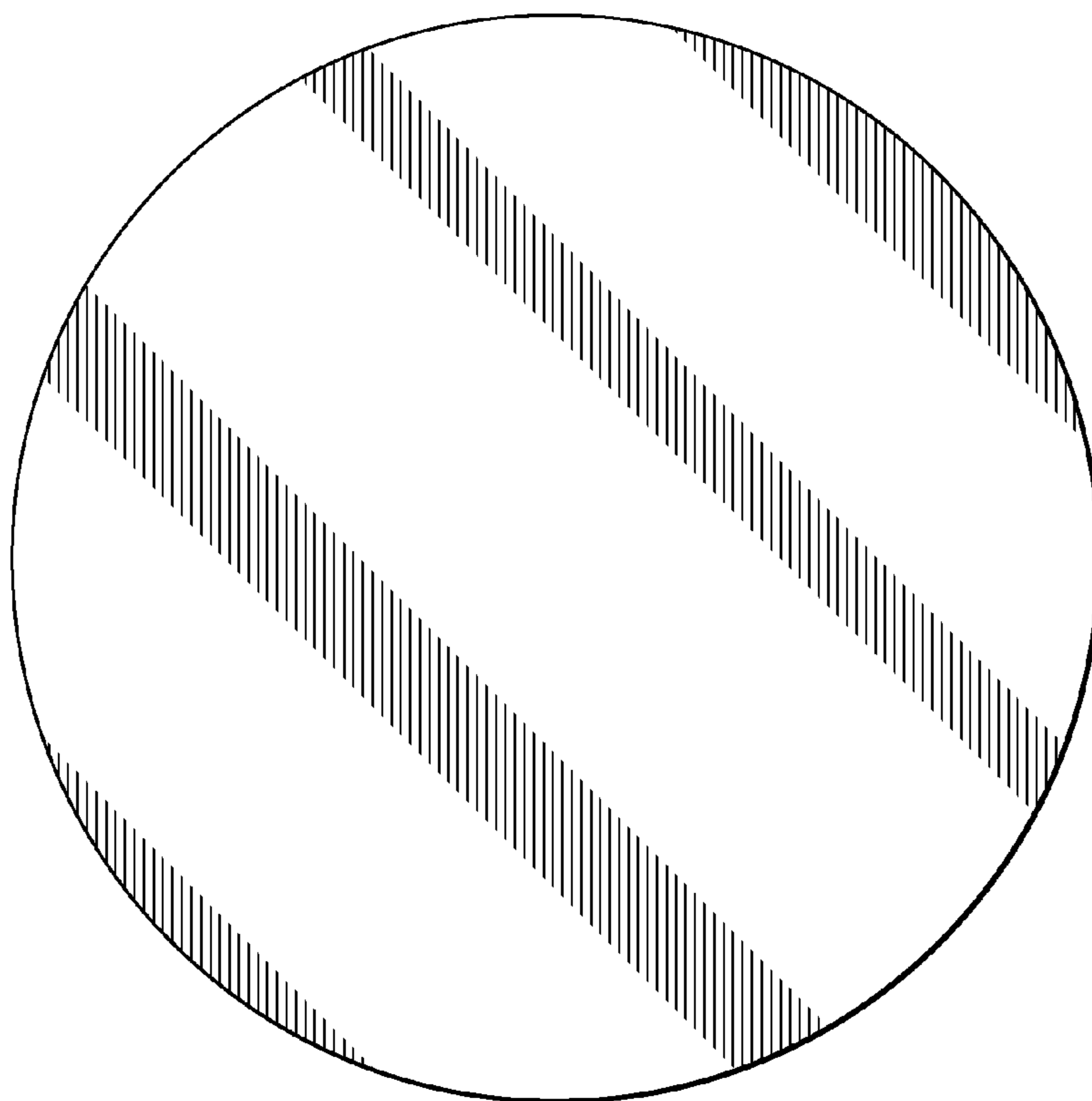

FIG. 10