



US00D577958S

(12) **United States Design Patent**
Homma

(10) **Patent No.:** **US D577,958 S**
(45) **Date of Patent:** **** Oct. 7, 2008**

(54) **MUG**

D571,154 S * 6/2008 Pearson D7/533

(75) Inventor: **Ken R. Homma**, Fountain Valley, CA (US)

* cited by examiner

(73) Assignee: **Logomark, Inc.**, Tustin, CA (US)

Primary Examiner—Philip Hyder
Assistant Examiner—Cynthia Underwood
(74) *Attorney, Agent, or Firm*—Larry K. Roberts

(**) Term: **14 Years**

(57) **CLAIM**

(21) Appl. No.: **29/306,980**

The ornamental design for a mug, as shown and described.

(22) Filed: **Apr. 21, 2008**

DESCRIPTION

Related U.S. Application Data

(60) Division of application No. 29/288,692, filed on Jun. 19, 2007, which is a continuation-in-part of application No. 29/273,472, filed on Mar. 5, 2007.

FIG. 1 is an isometric view of an embodiment of the design; FIG. 2 is a top view of the embodiment of FIG. 1; FIG. 3 is a left side view of the embodiment of FIG. 1; FIG. 4 is a front view of the embodiment of FIG. 1; FIG. 5 is a right side view of the embodiment of FIG. 1; FIG. 6 is a back view of the embodiment of FIG. 1; FIG. 7 is a bottom view of the embodiment of FIG. 1; FIG. 8 is an isometric view of another embodiment of the design; FIG. 9 is a top view of the embodiment of FIG. 8; FIG. 10 is a left side view of the embodiment of FIG. 8; FIG. 11 is a front view of the embodiment of FIG. 8; FIG. 12 is a right side view of the embodiment of FIG. 8; FIG. 13 is a back view of the embodiment of FIG. 8; and, FIG. 14 is a bottom view of the embodiment of FIG. 8.

(51) **LOC (8) Cl.** **07-01**
(52) **U.S. Cl.** **D7/510; D7/509**
(58) **Field of Classification Search** D7/510, D7/509, 523, 312, 511; 215/11.6, 200, 387, 215/DIG. 7; 220/711, 719, 298, 592.16, 220/592.17, 703; D3/202; D9/516; D24/197; 229/404

See application file for complete search history.

The features on the drawing in broken lines depicting lid features are for illustrative purposes only and are not a part of the scope of the claim of the embodiment in which they are shown.

(56) **References Cited**

U.S. PATENT DOCUMENTS

D38,167 S * 8/1906 Wintermann D9/500
1,197,389 A * 9/1916 Newton 215/383
1,832,806 A * 11/1931 Dawson 215/43
D120,587 S * 5/1940 Hinkins D9/500
D185,649 S * 7/1959 Schlumbohm D7/523
D357,414 S * 4/1995 Kornick et al. D9/776
D483,611 S * 12/2003 Diak Ghanem D7/523
D488,348 S * 4/2004 Liu D7/523
D519,784 S * 5/2006 Karp D7/523
D531,452 S * 11/2006 Toth D7/523
D535,151 S * 1/2007 Seum et al. D7/510
D545,131 S * 6/2007 Seum et al. D7/523
D547,611 S * 7/2007 Seum et al. D7/511
D562,076 S * 2/2008 Sandberg D7/533

The broken lines on the lid in FIGS. 1, 2, 8 and 9 show portions of the design that form no part of the claim. The broken lines on the body of the mug in FIGS. 8 and 10–13 represent the boundaries of the claimed design.

1 Claim, 4 Drawing Sheets

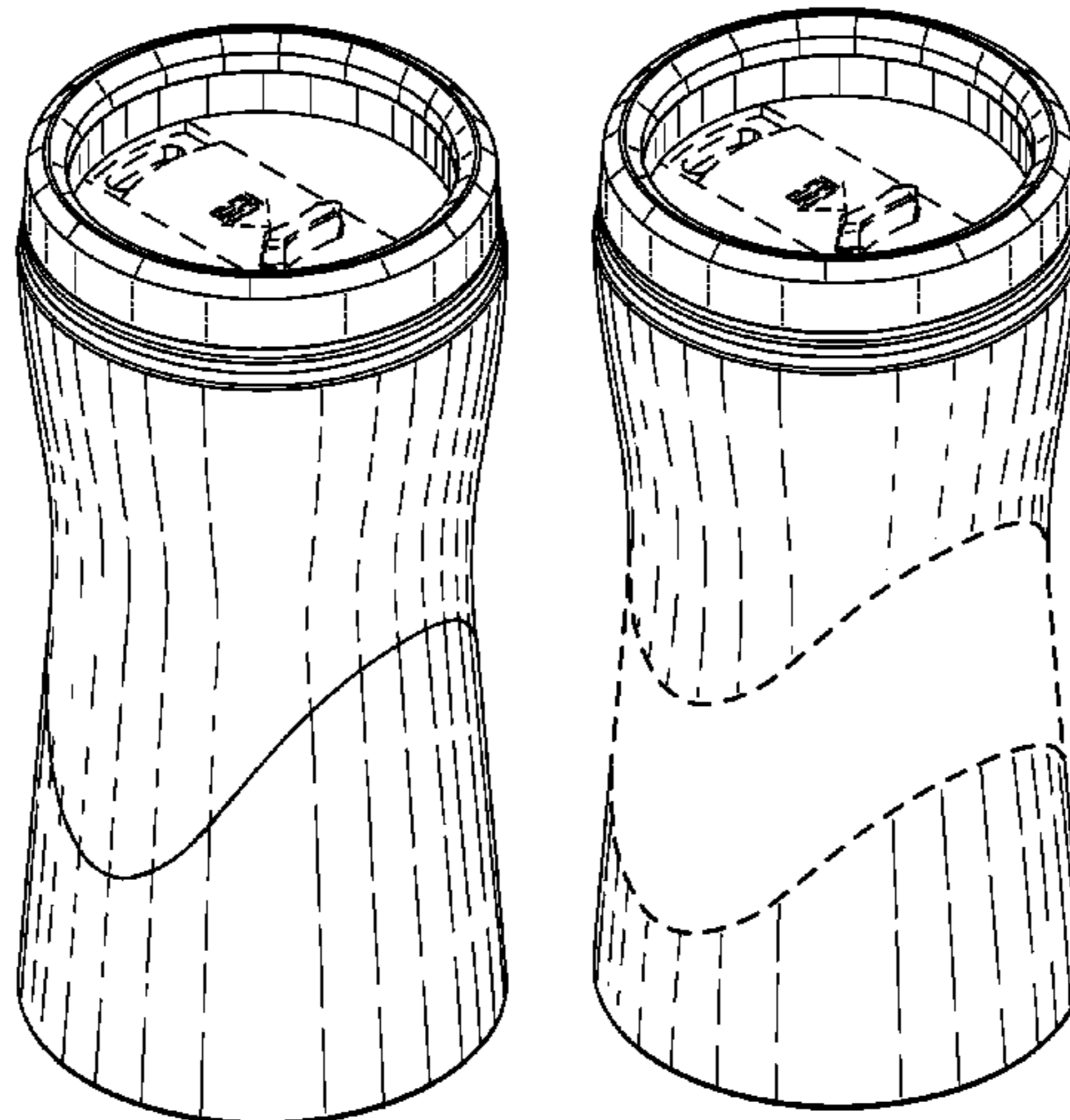

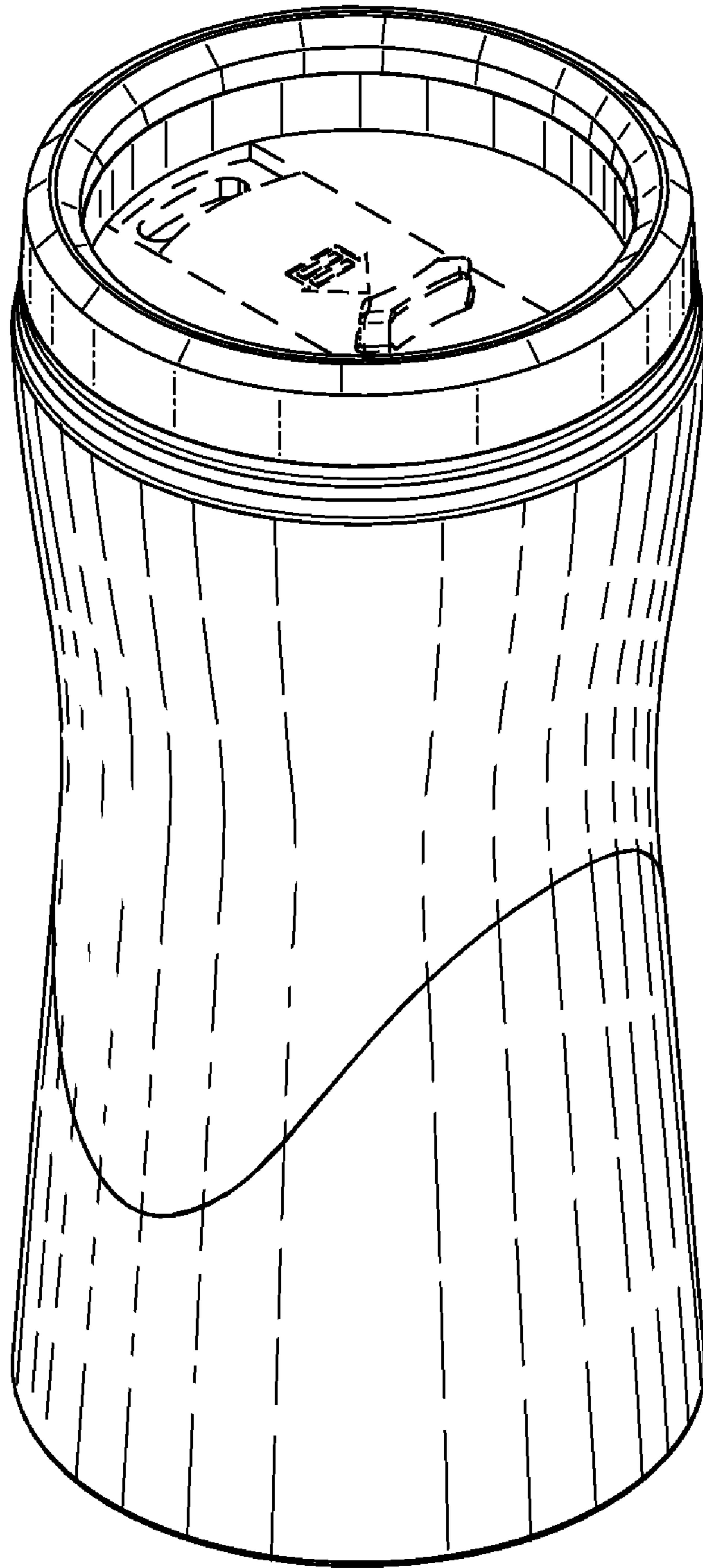

FIG. 1

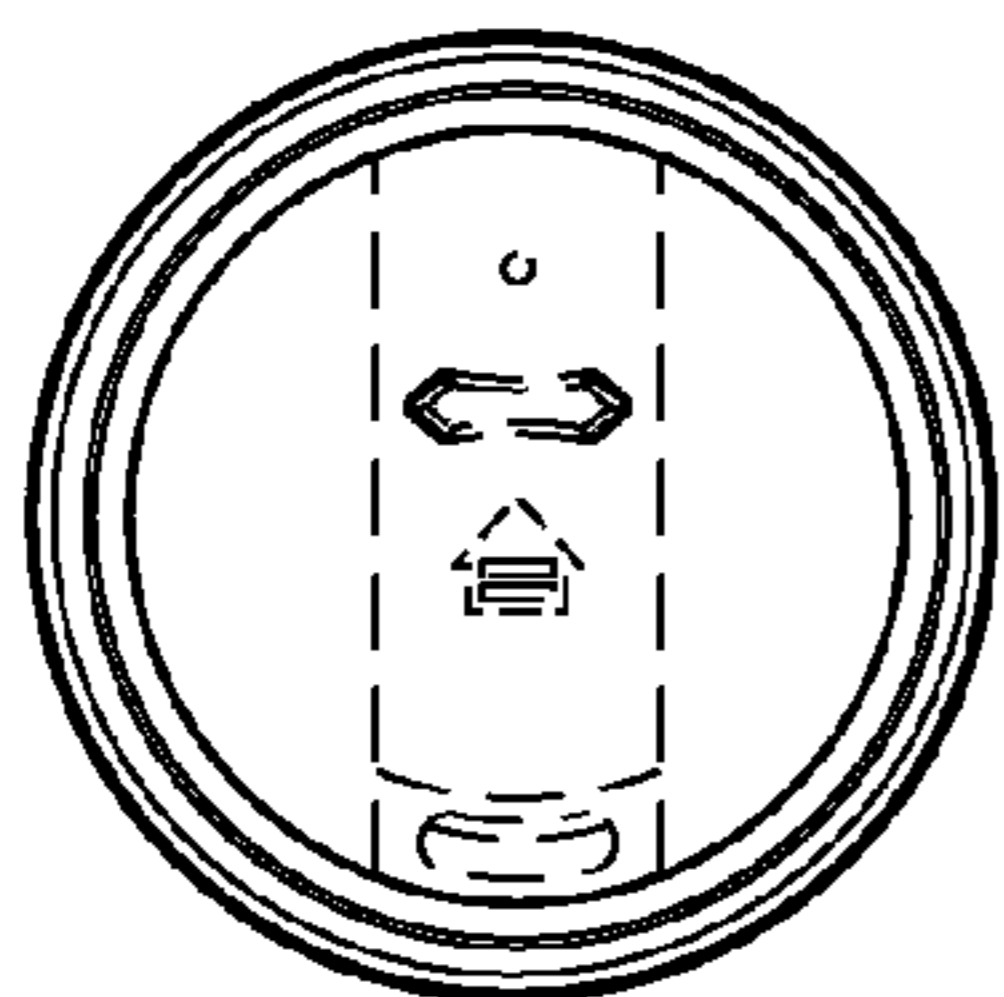

FIG. 2

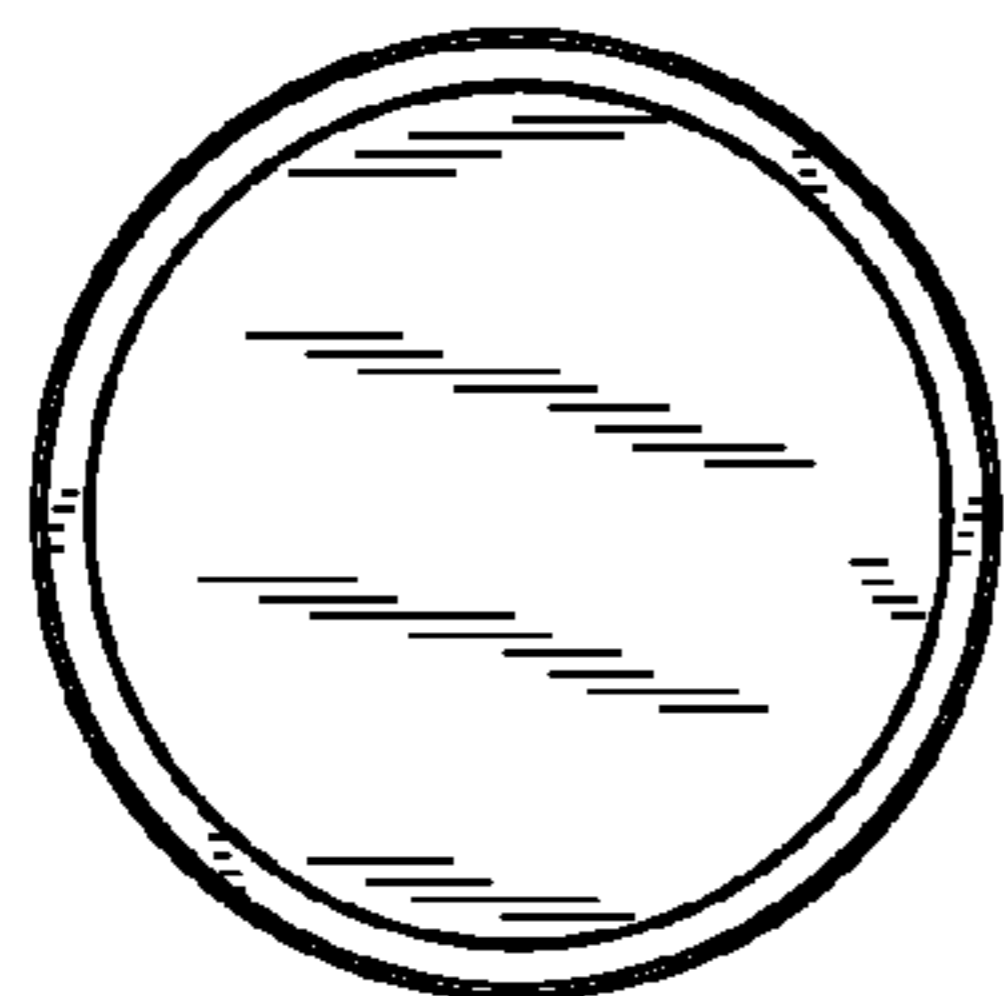

FIG. 7

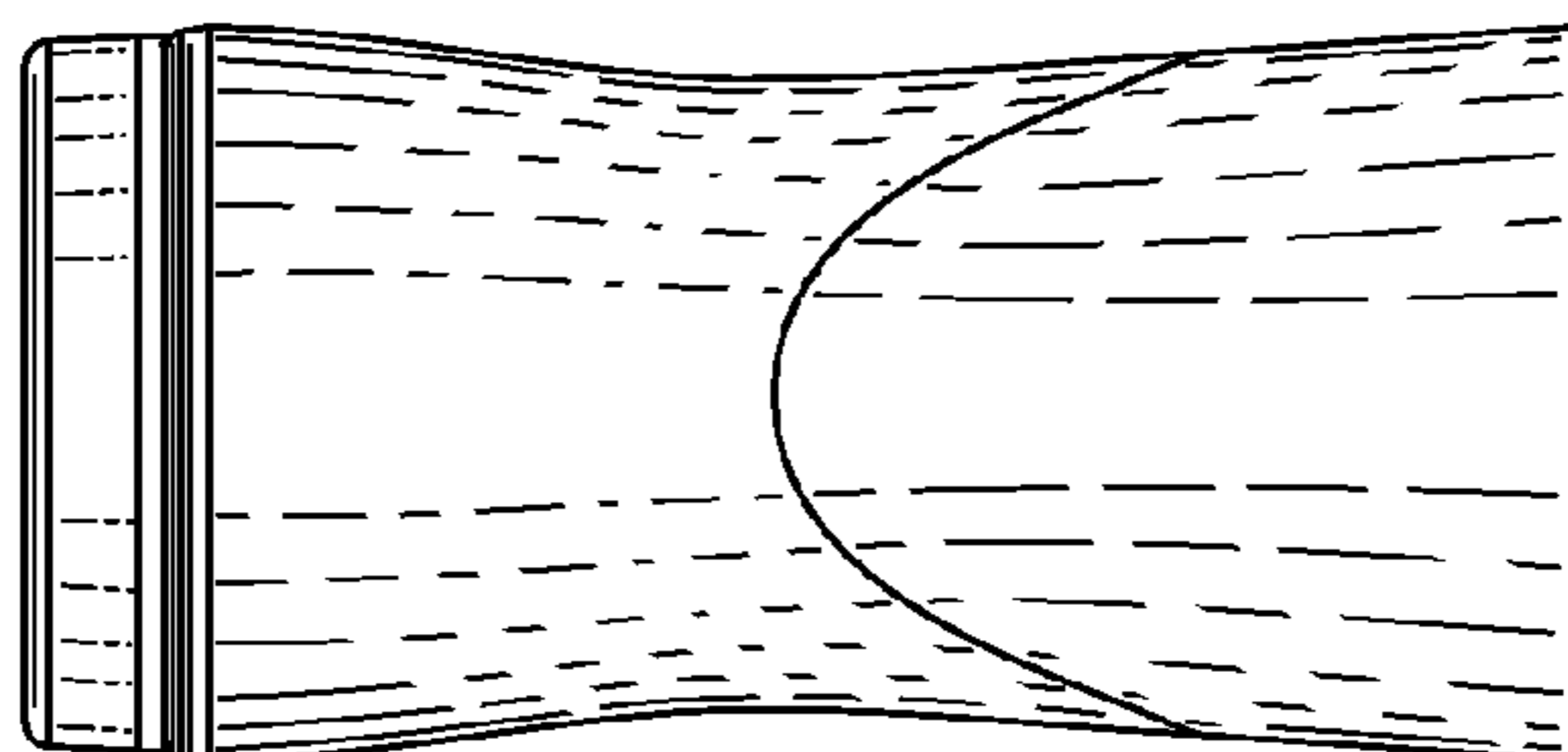

FIG. 3

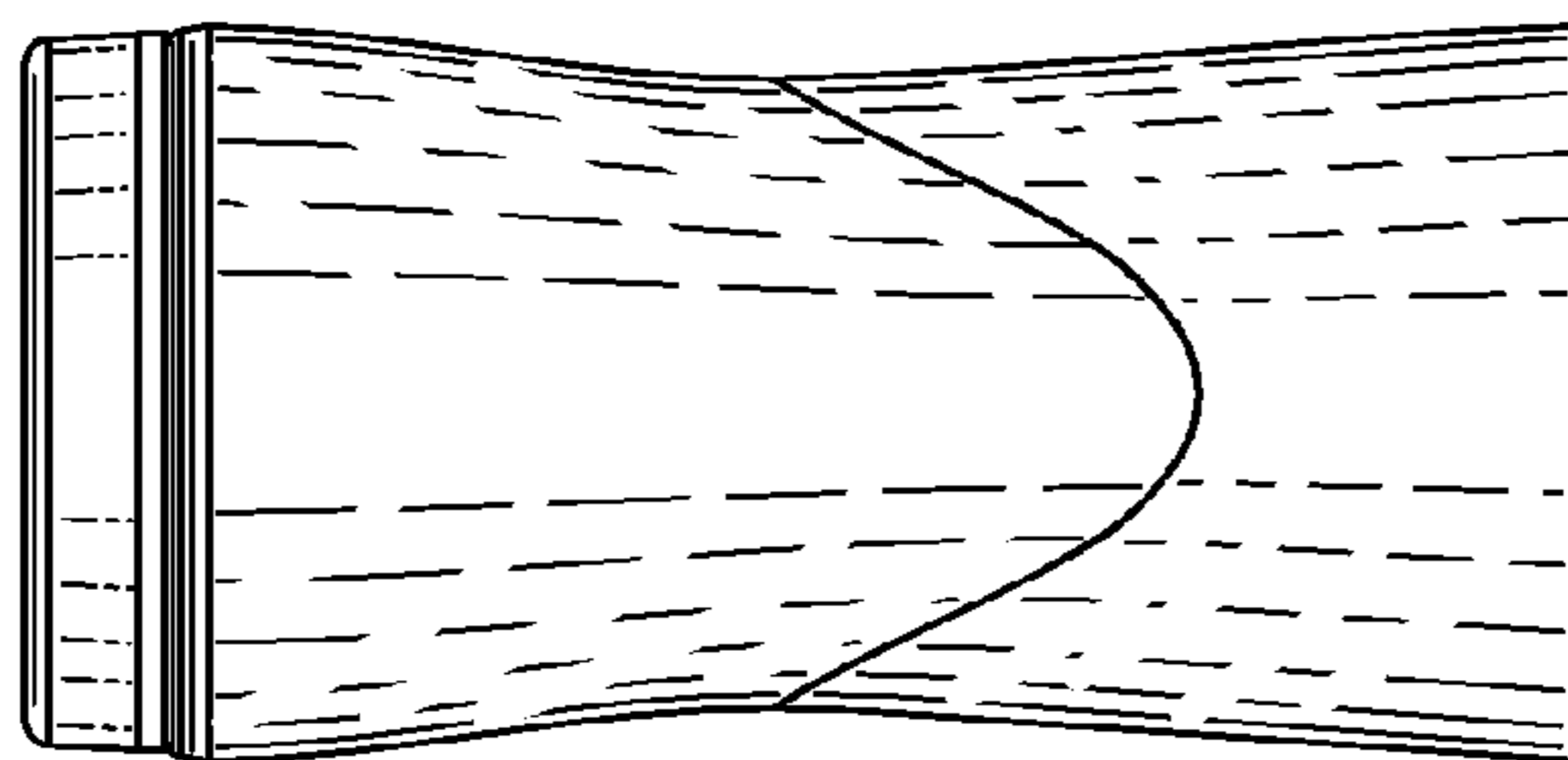

FIG. 4

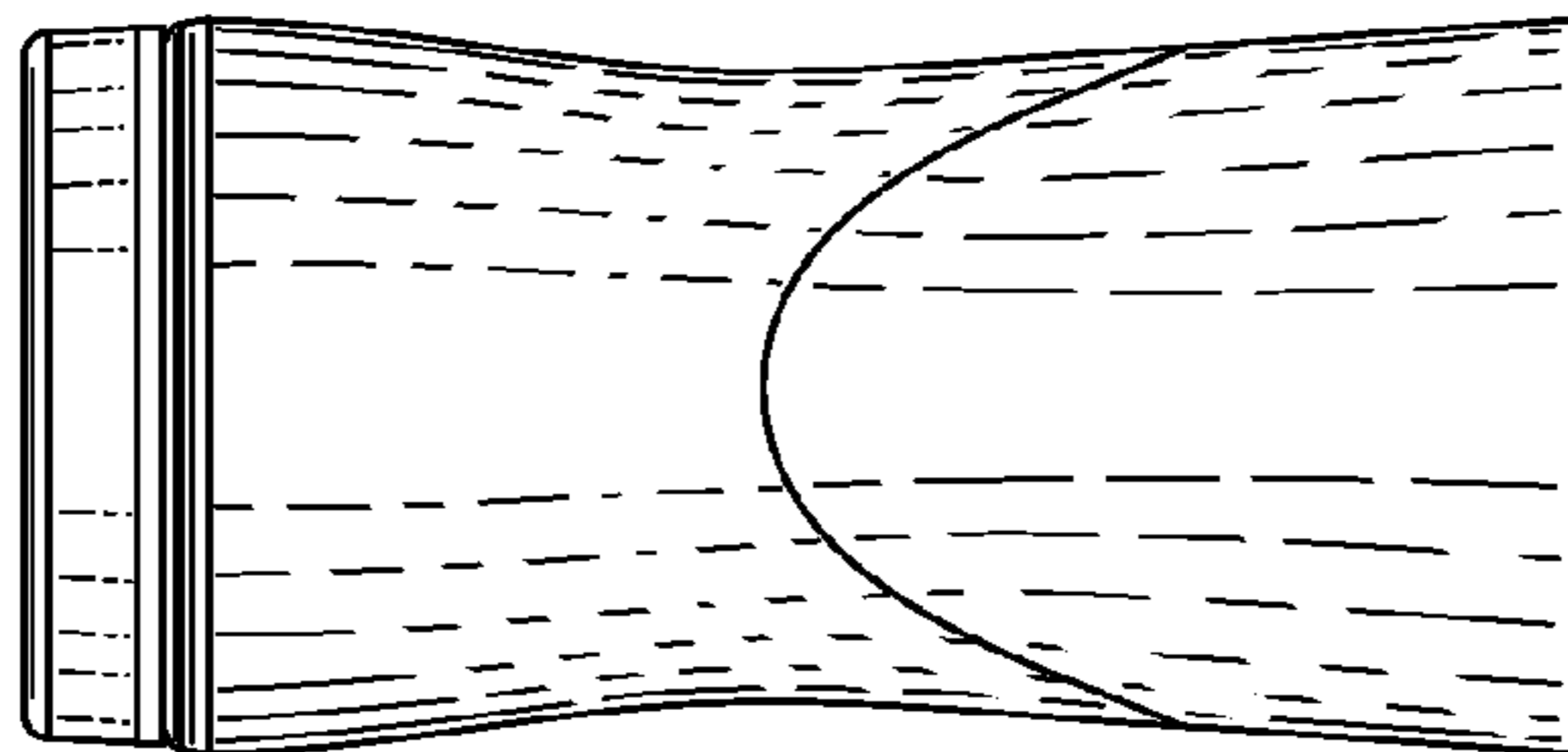

FIG. 5

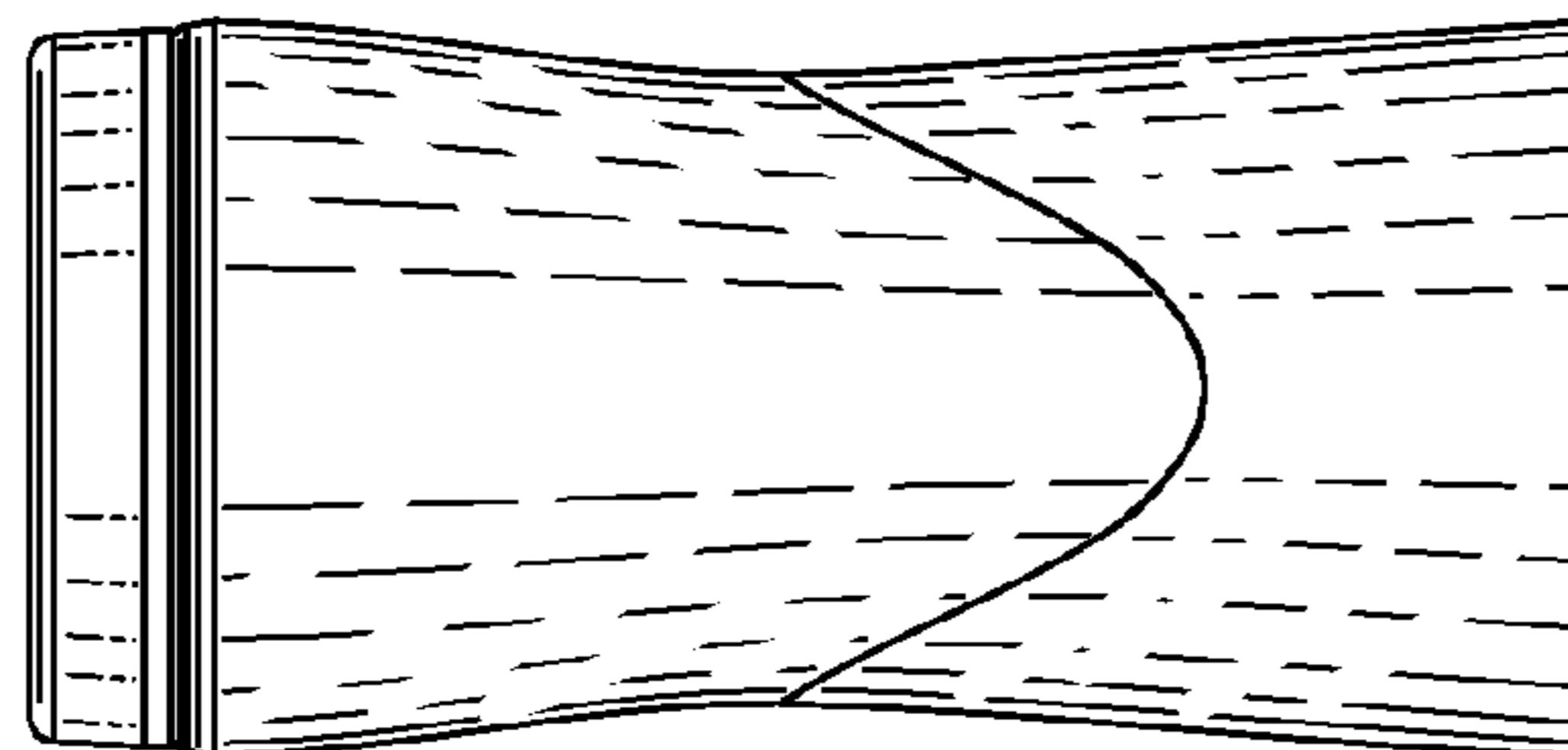

FIG. 6

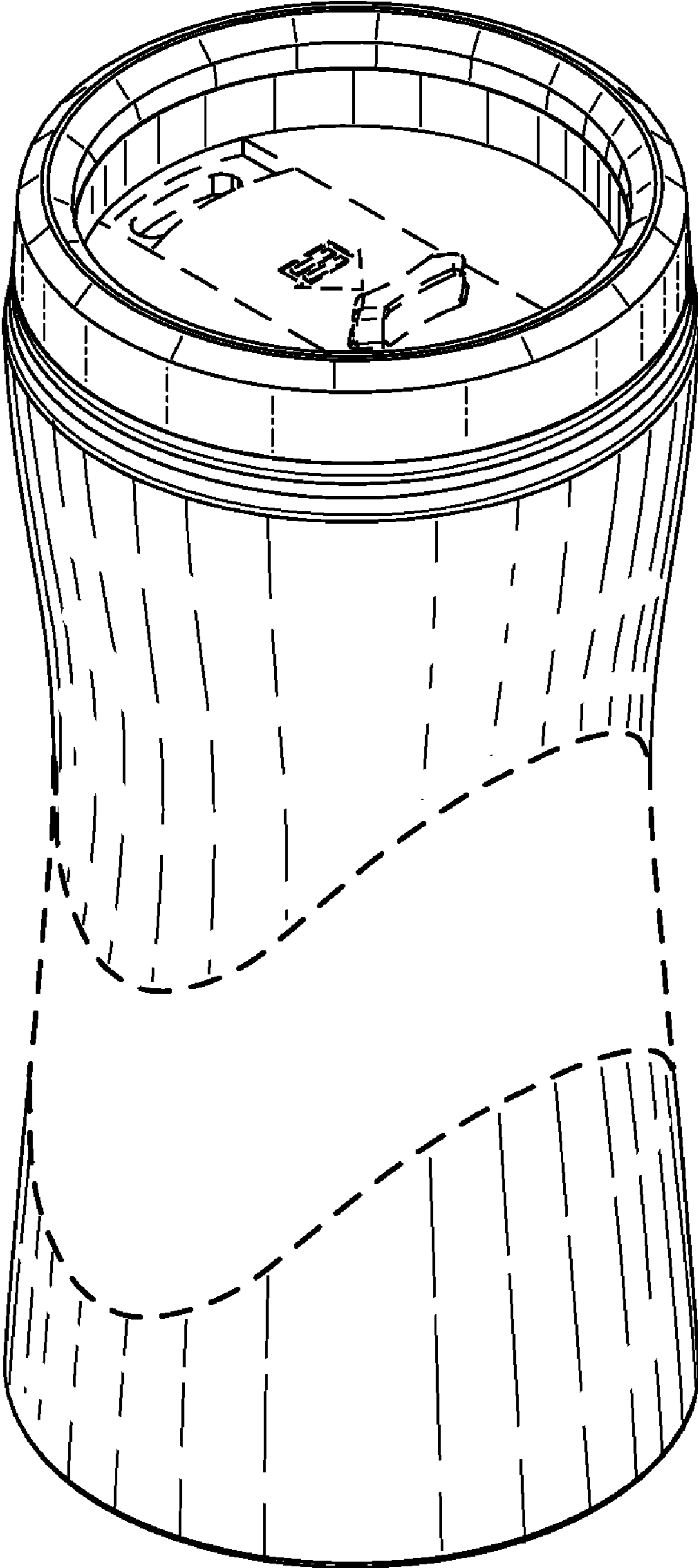

FIG. 8

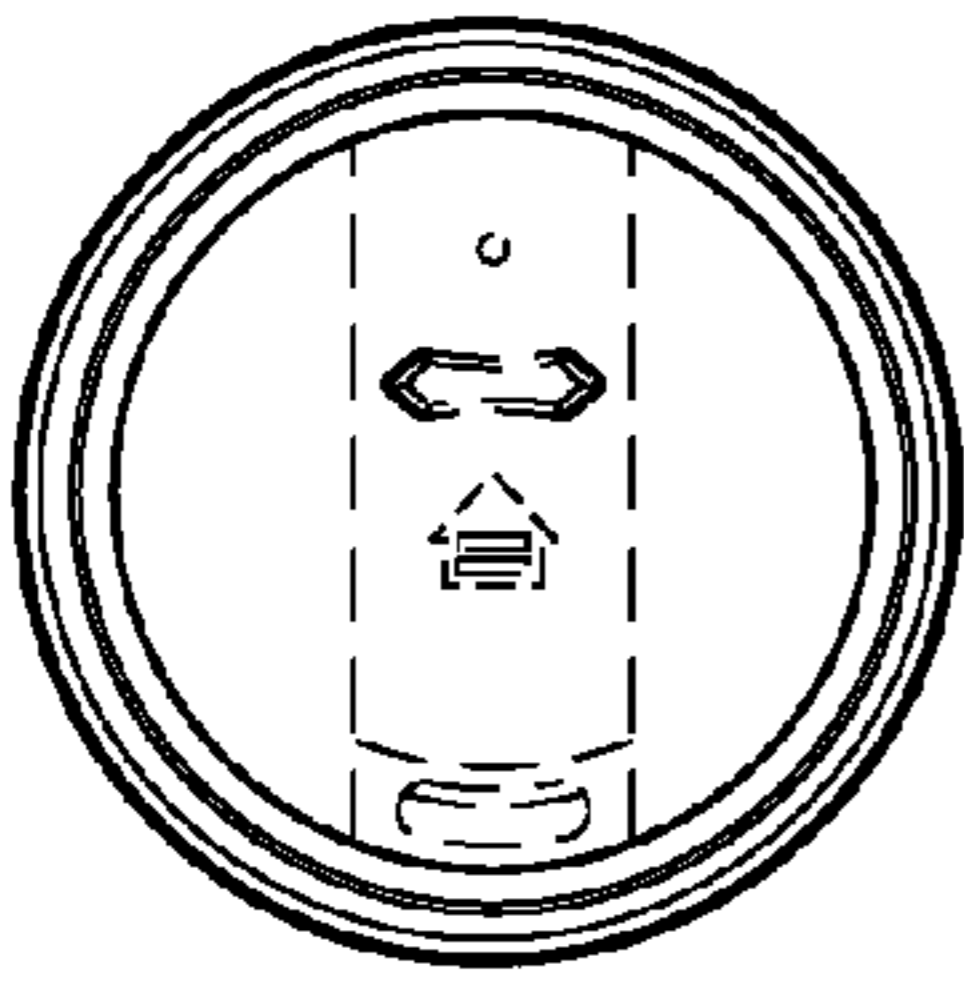

FIG. 9

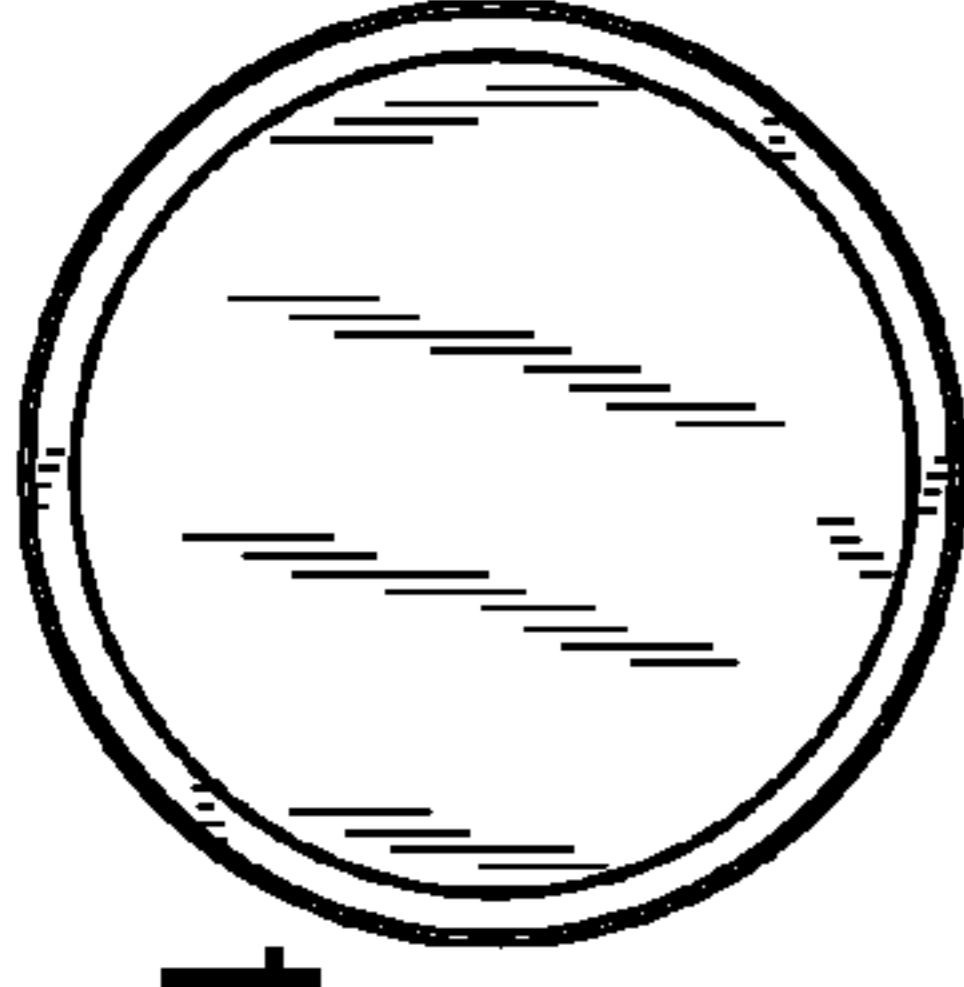

FIG. 14

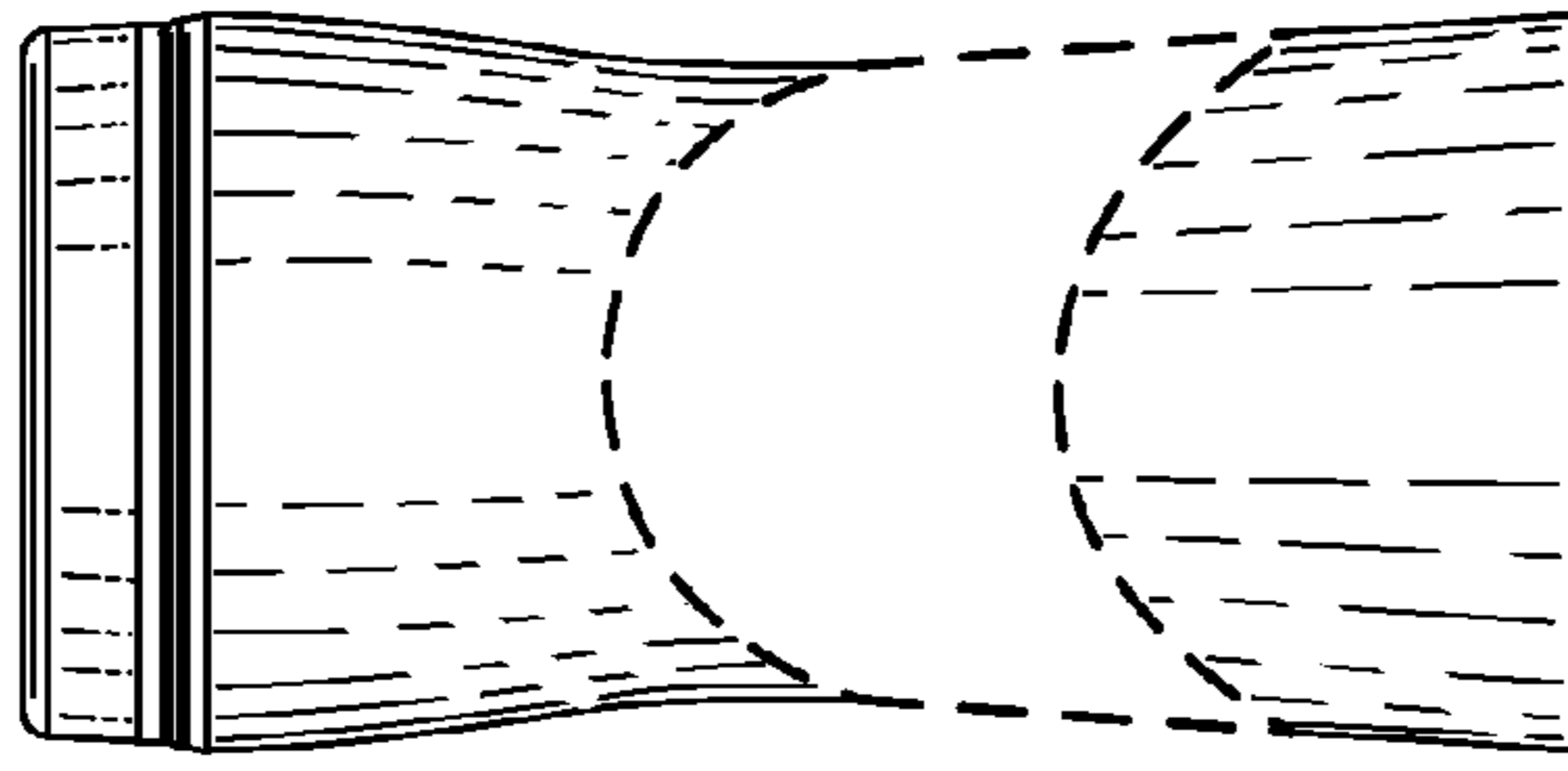

FIG. 10

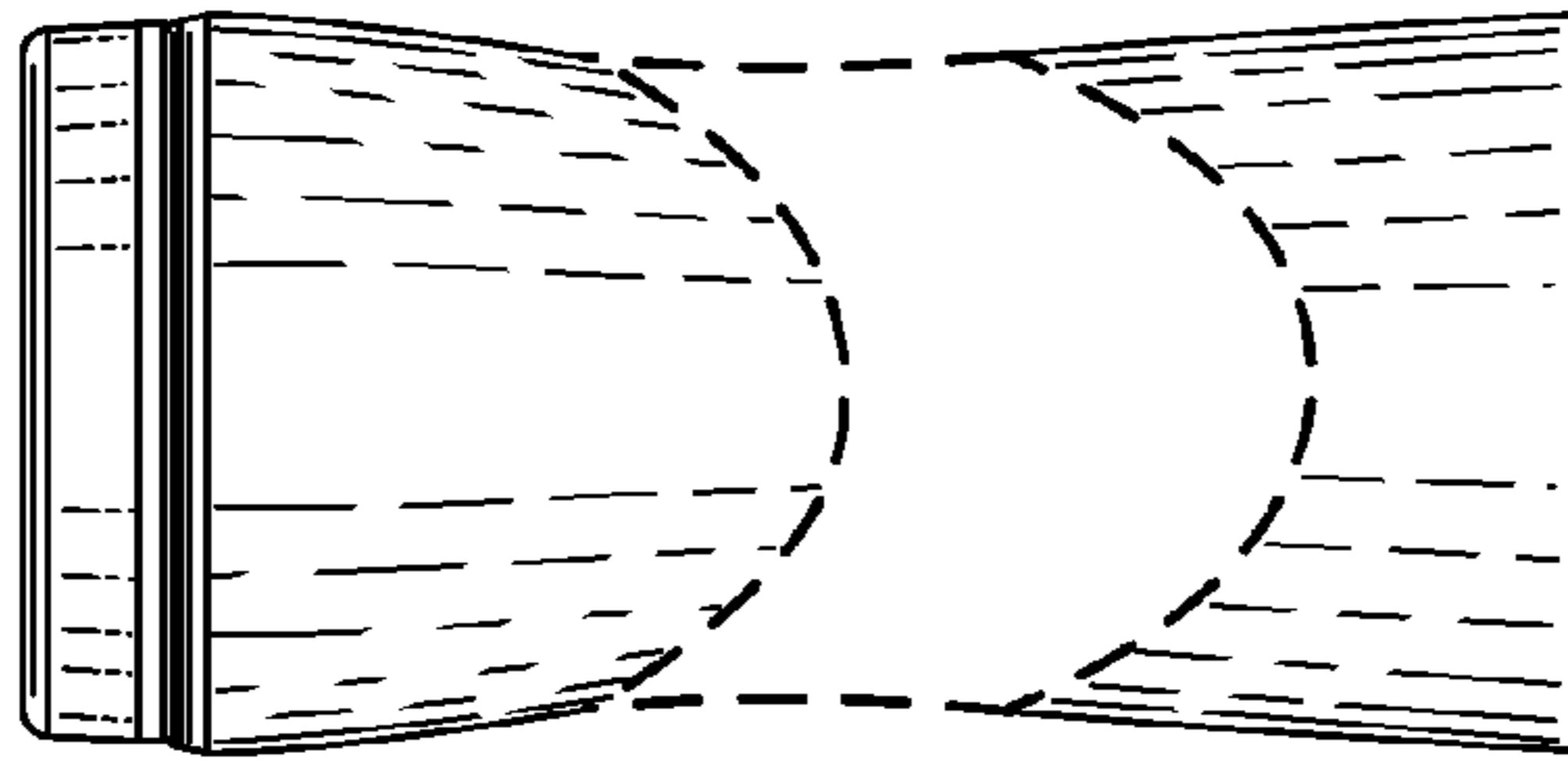

FIG. 11

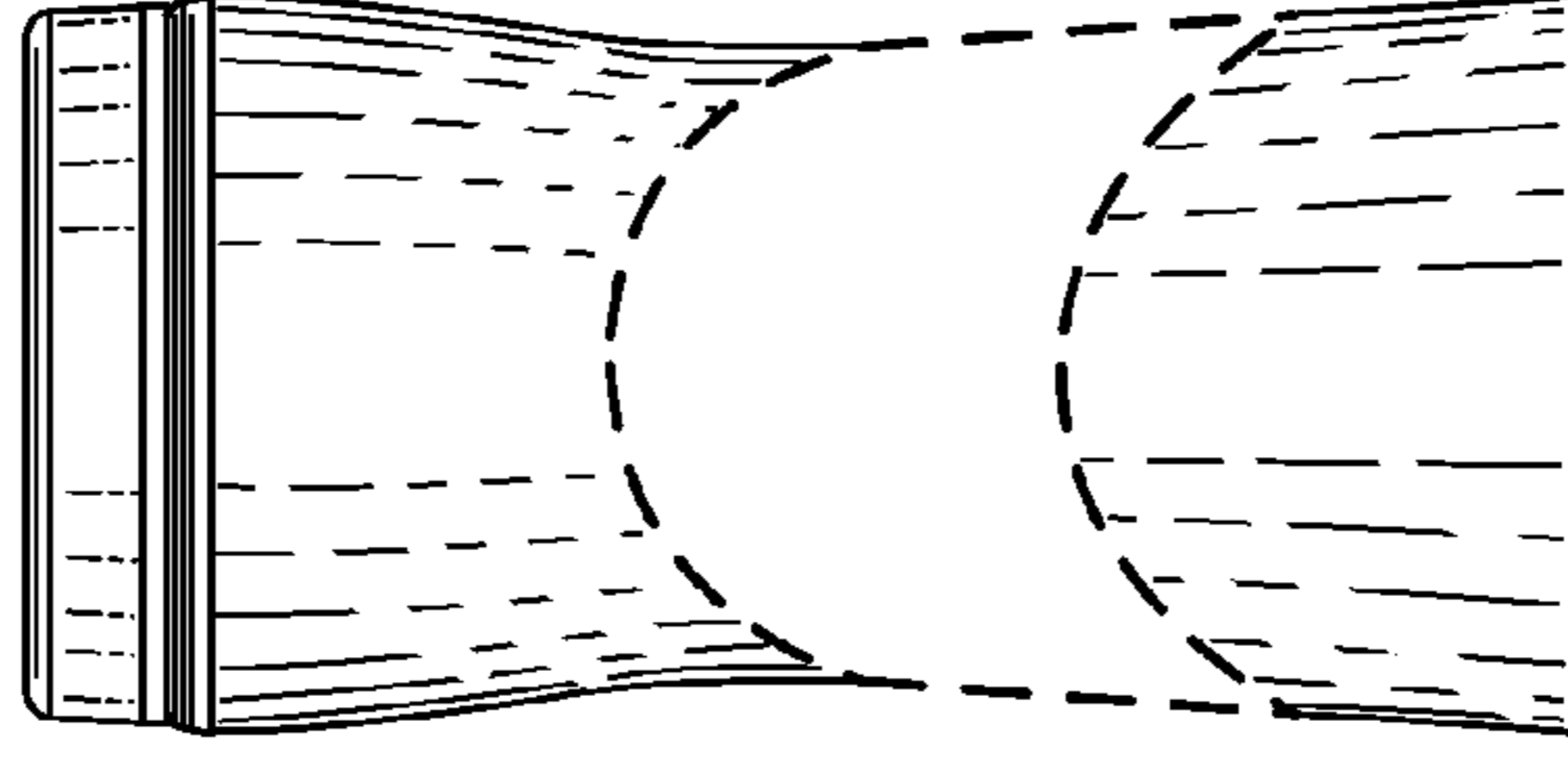

FIG. 12

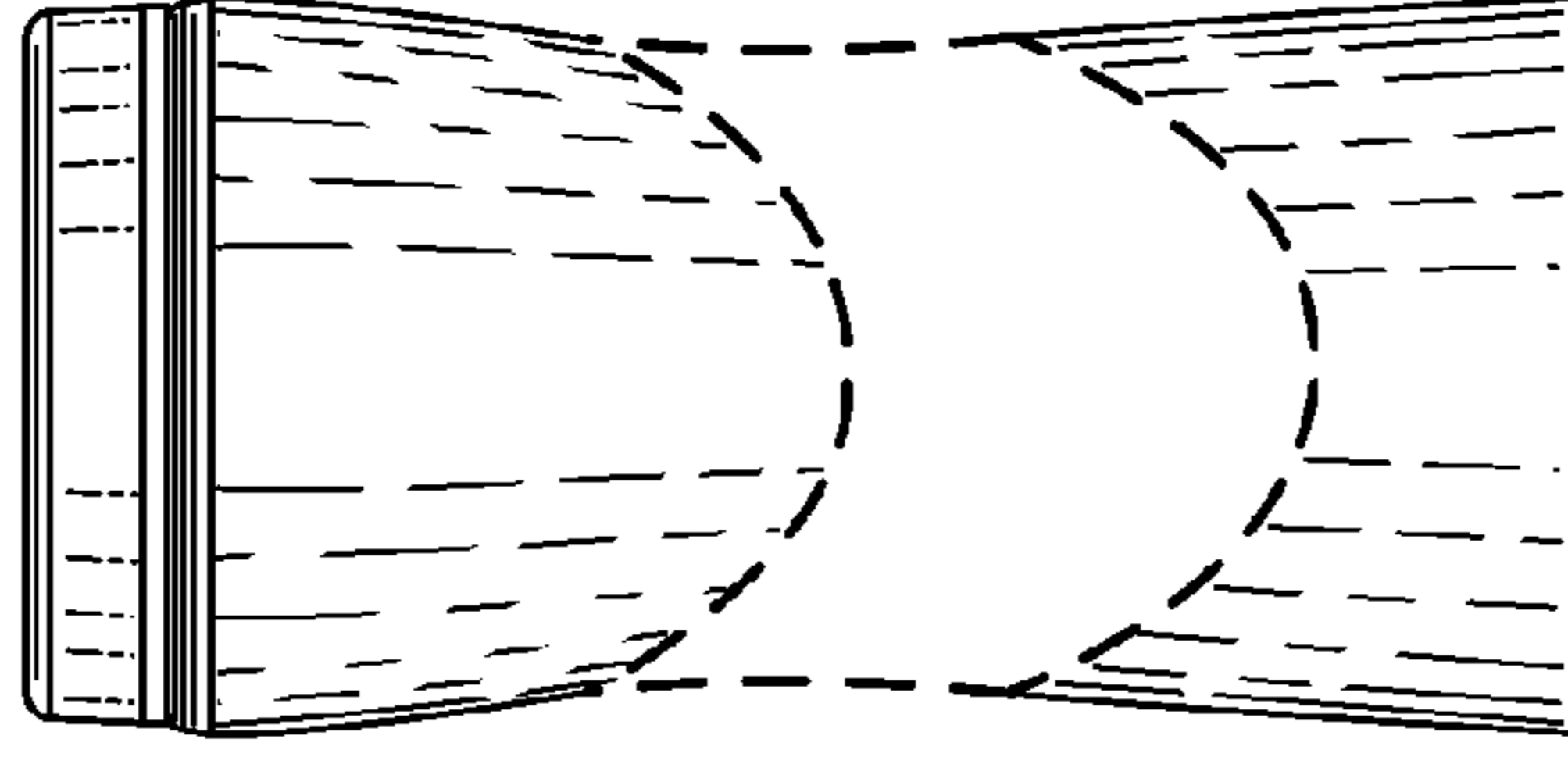

FIG. 13