



US00D577897S

(12) **United States Design Patent**
Belley et al.

(10) **Patent No.:** **US D577,897 S**
(45) **Date of Patent:** **** Oct. 7, 2008**

(54) **FOOTWEAR UPPER**

(75) Inventors: **Manon Belley**, Laval (CA); **Annamaria Furlanetto**, Montebelluna (IT); **Cristian Ardissono**, Venegazzu del Montello (IT)

(73) Assignee: **Wolverine World Wide, Inc.**, Rockford, MI (US)

(**) Term: **14 Years**

(21) Appl. No.: **29/293,047**

(22) Filed: **Nov. 7, 2007**

(51) **LOC (8) Cl.** **02-99**

(52) **U.S. Cl.** **D2/969**

(58) **Field of Classification Search** D2/896,
D2/902, 903, 906-910, 943, 944, 946, 969,
D2/972-974; 36/45, 50.1, 77 M, 77 R, 83,
36/88, 113, 114, 126-131

See application file for complete search history.

(56) **References Cited**

U.S. PATENT DOCUMENTS

D448,148 S	9/2001	Matis et al.	
D475,186 S	* 6/2003	Shea et al. D2/969
D480,543 S	10/2003	Robbins	
D487,335 S	3/2004	Robbins	
D487,619 S	3/2004	Matis	
D487,957 S	4/2004	Robbins	
D487,961 S	4/2004	Robbins	
D500,196 S	12/2004	Belley	
D501,295 S	2/2005	Belley et al.	
D501,298 S	2/2005	Robbins et al.	
D501,982 S	2/2005	Belley et al.	
D504,560 S	5/2005	Robbins et al.	
D507,864 S	8/2005	Robbins et al.	
D514,299 S	2/2006	Ardissono et al.	
D514,789 S	2/2006	Robbins et al.	
D514,791 S	2/2006	Ardissono et al.	
D517,302 S	3/2006	Ardissono	

D519,721 S	*	5/2006	Castillo	D2/909
D537,612 S		3/2007	Belley et al.		
D538,521 S		3/2007	Matis et al.		
D546,535 S		7/2007	Belley et al.		
D547,040 S		7/2007	Belley et al.		
D547,043 S		7/2007	Matis et al.		
D547,044 S		7/2007	Belley et al.		
D547,535 S		7/2007	Matis et al.		
D554,843 S		11/2007	Matis		
D559,520 S	*	1/2008	Belley et al.	D2/969

OTHER PUBLICATIONS

Merrell Spring 2008 Catalog, pp. 97 and 94.
Hush Puppies Women's Spring 2008 Catalog, pp. 6 and 11.

* cited by examiner

Primary Examiner—Dominic Simone

(74) *Attorney, Agent, or Firm*—Warner Norcross & Judd LLP

(57) **CLAIM**

The ornamental design for footwear upper, as shown and described.

DESCRIPTION

FIG. 1 is a perspective view of the footwear upper embodying the new design;

FIG. 2 is a top view thereof;

FIG. 3 is a right side view thereof;

FIG. 4 is a left side view thereof;

FIG. 5 is a front view thereof; and,

FIG. 6 is a rear view thereof.

FIGS. 1-6 show features of an article of footwear in phantom lines. These features are shown for environmental purposes and do not form any part of the claimed design. Further, the phantom lines immediately adjacent the solid-line portions of the design form the boundary of the design, with the phantom lines forming no part of the claimed design.

1 Claim, 4 Drawing Sheets

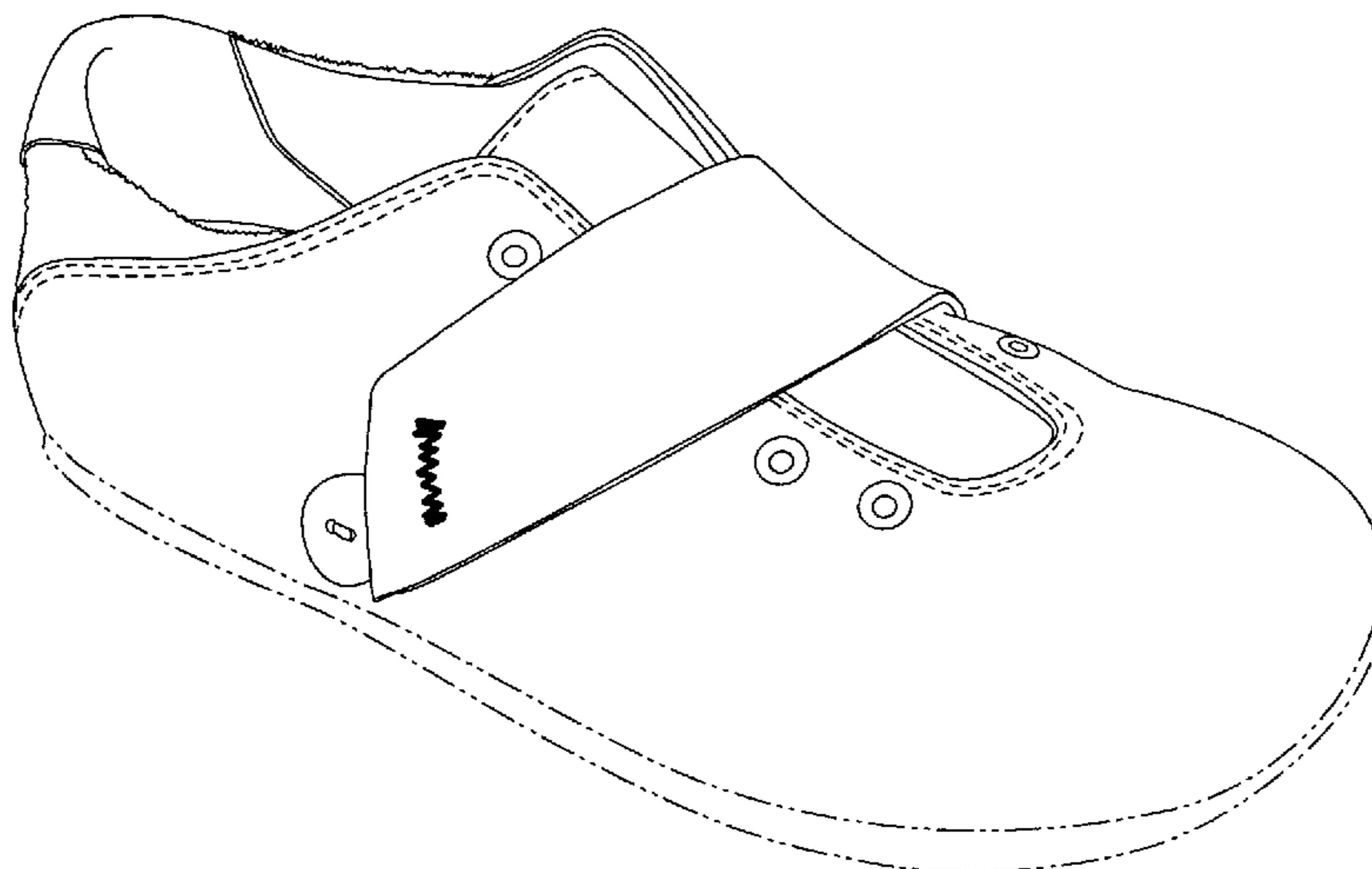

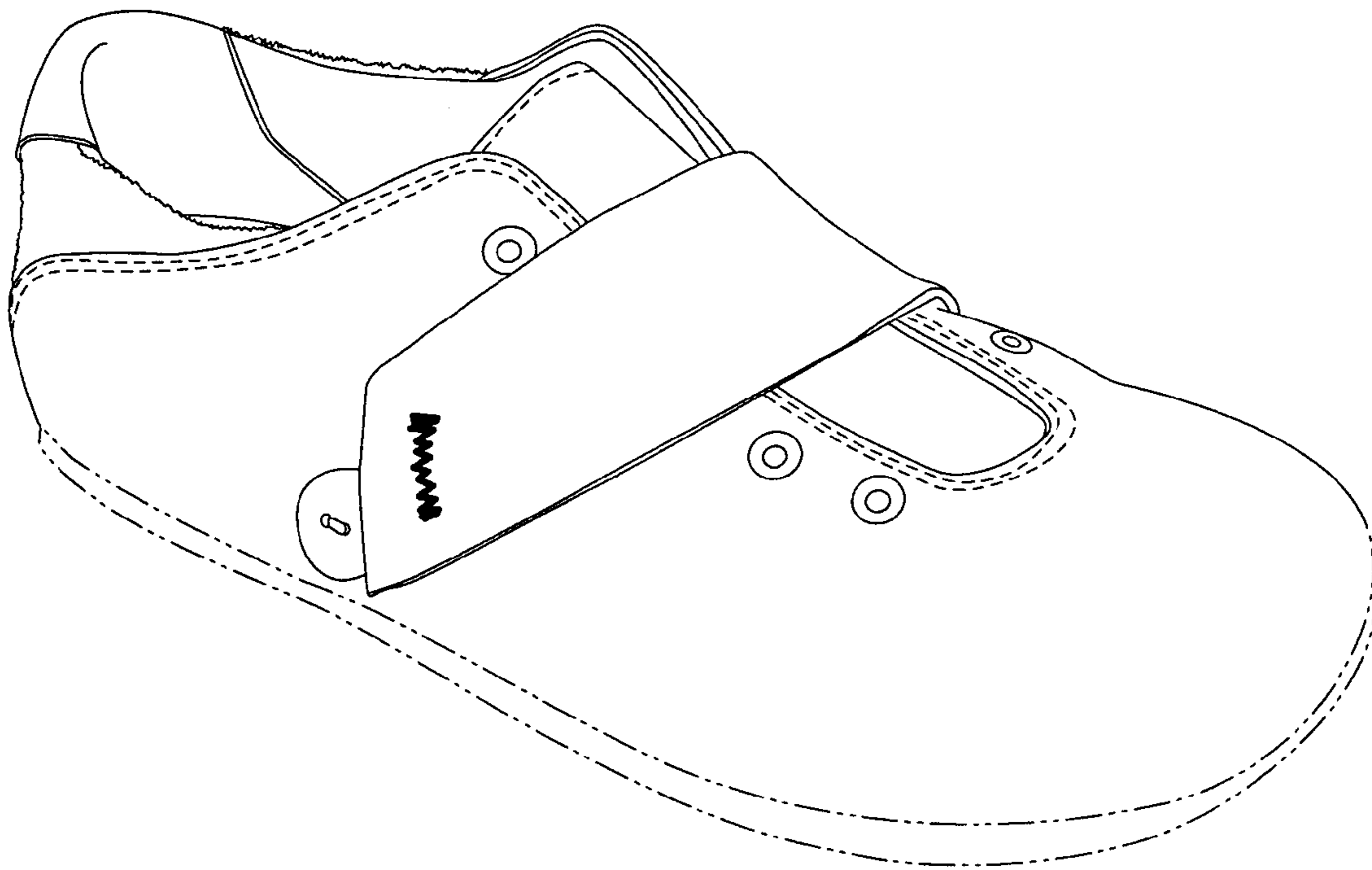

Fig. 1

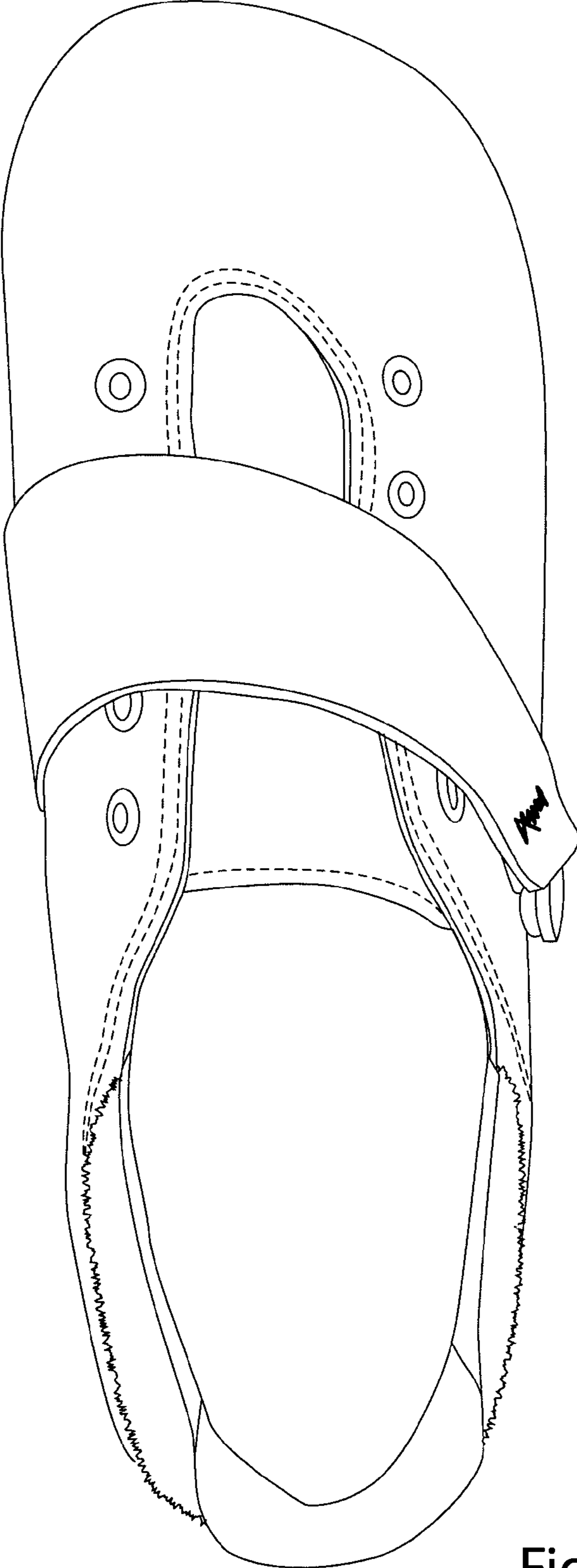

Fig. 2

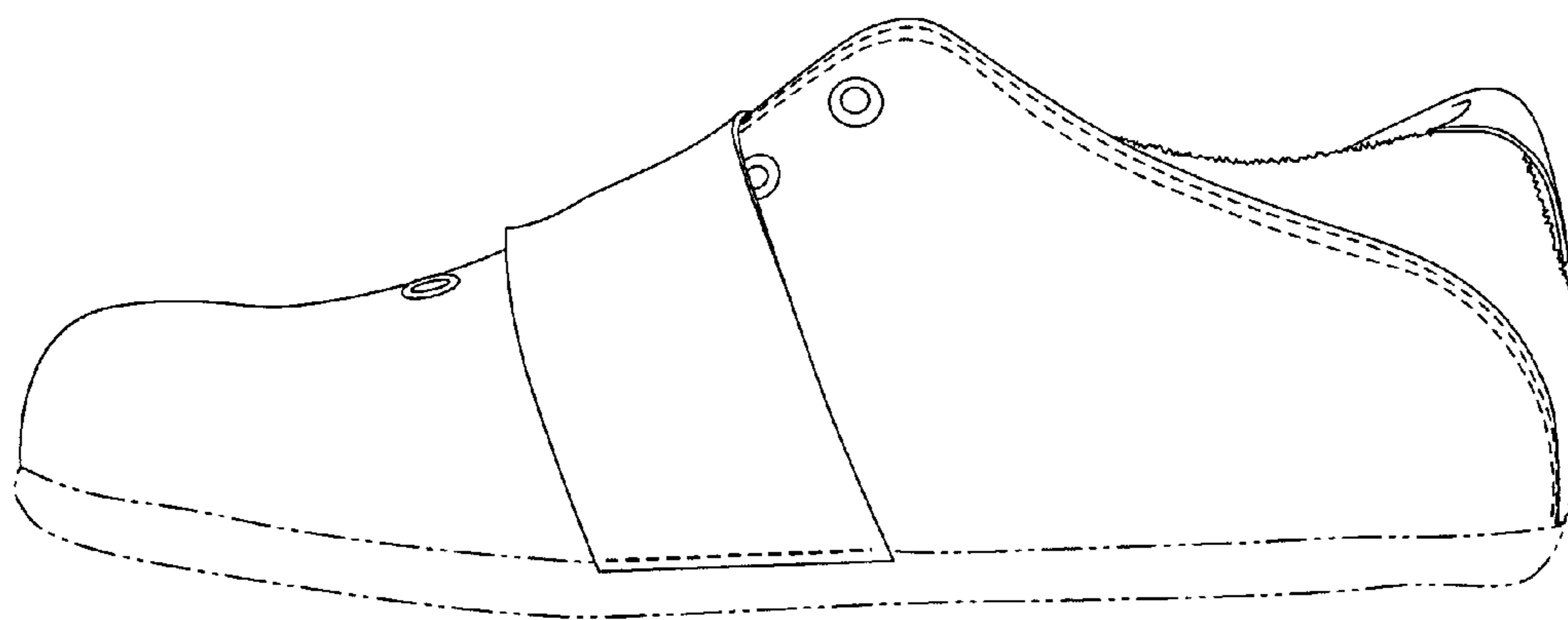

Fig. 3

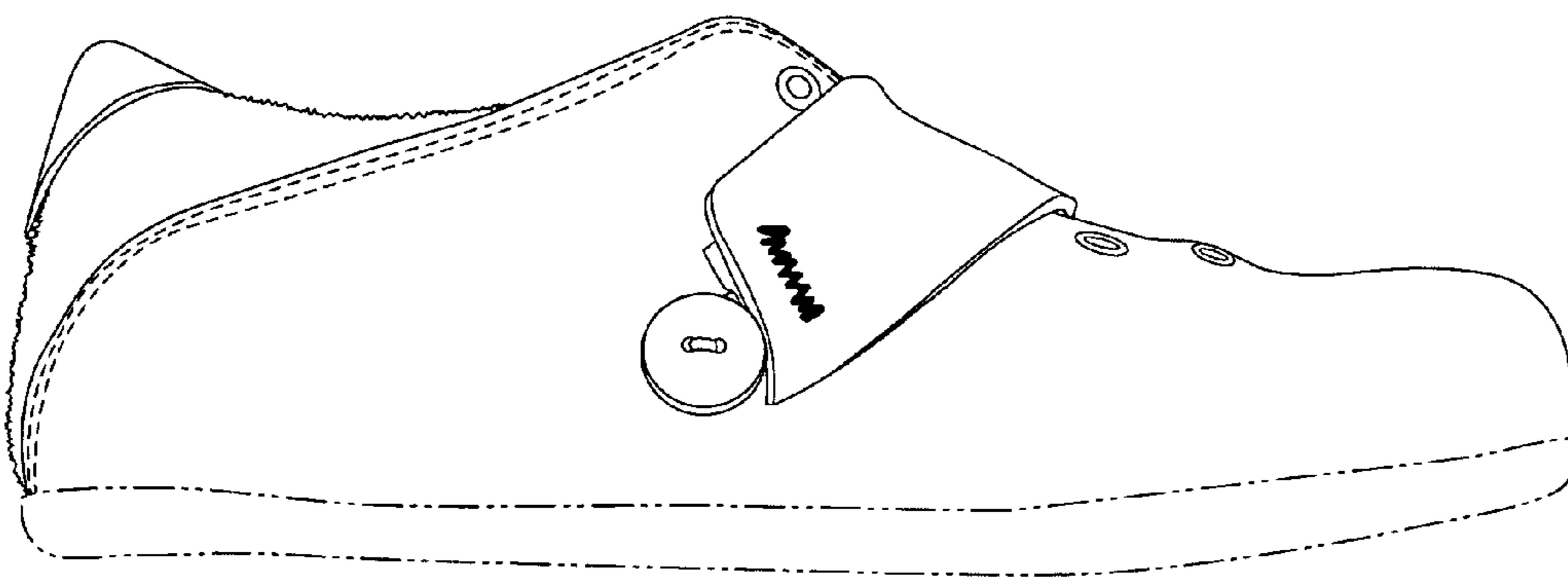

Fig. 4

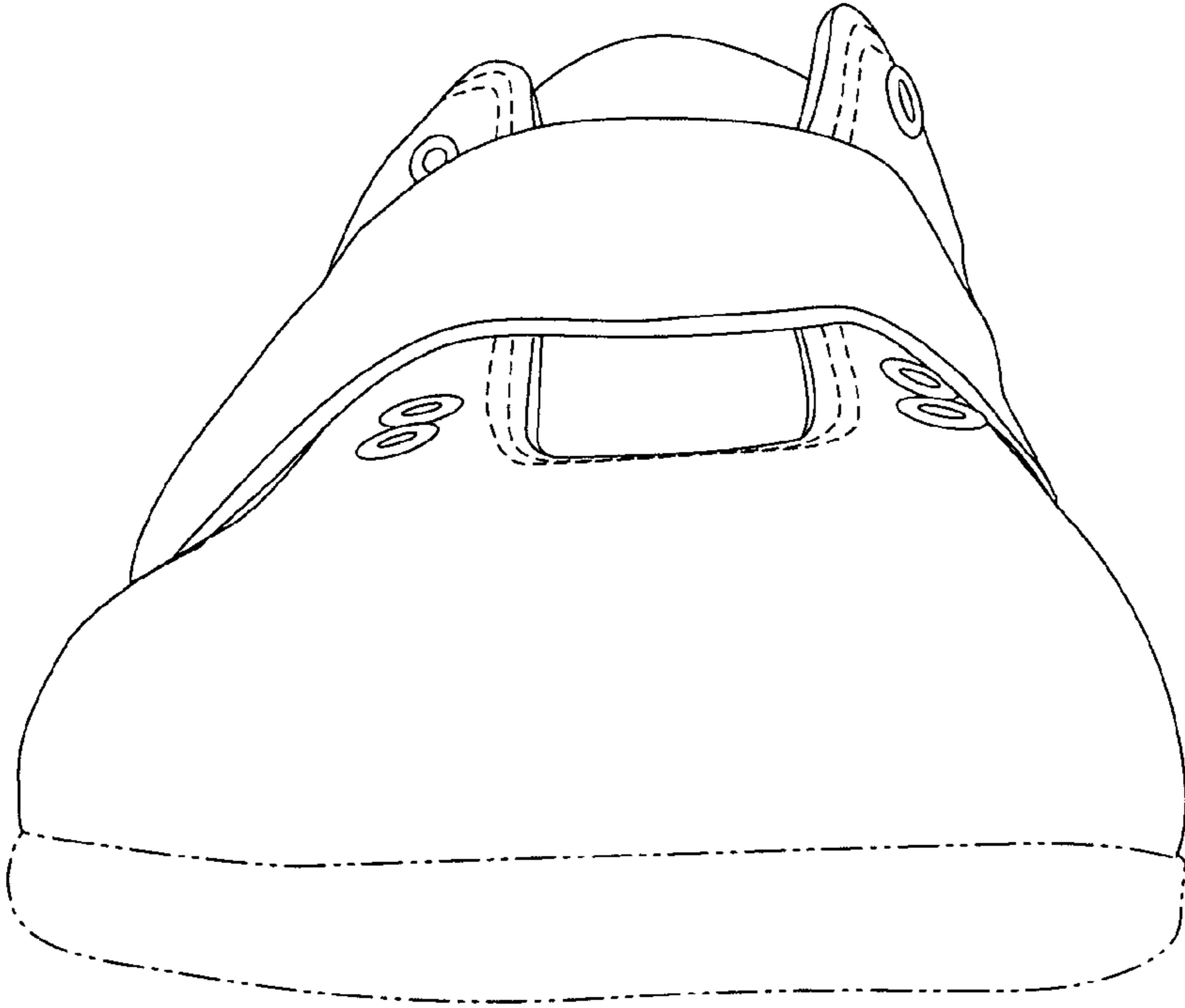

Fig. 5

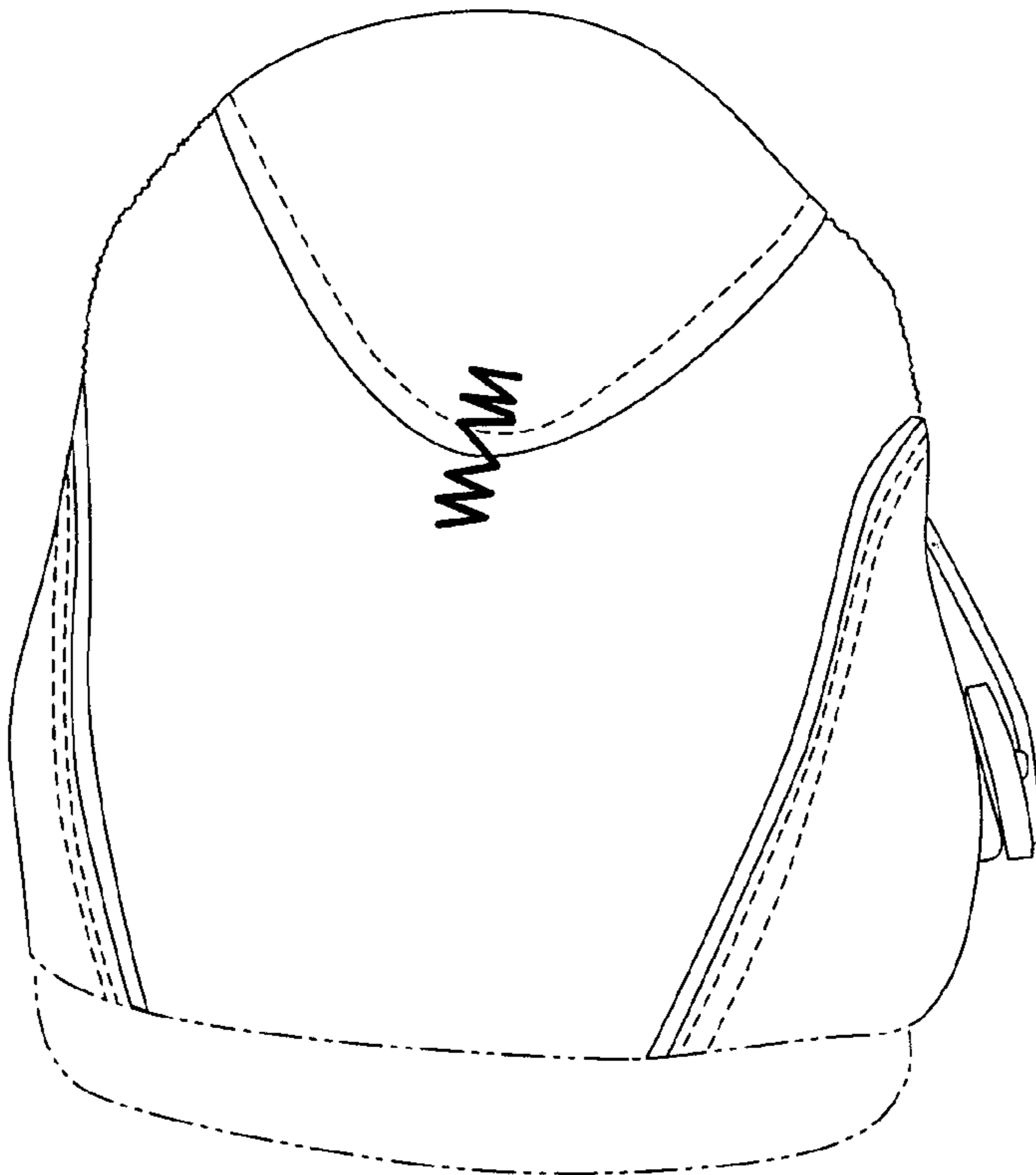

Fig. 6