



US00D577801S

(12) **United States Design Patent**  
**Schultz et al.**

(10) **Patent No.:** **US D577,801 S**

(45) **Date of Patent:** **\*\* Sep. 30, 2008**

(54) **AIR PURIFIER**

(75) Inventors: **Marissa A. K. Schultz**, Racine, WI  
(US); **Thomas Van Dyk**, Ramsey, NJ  
(US)

(73) Assignee: **S.C. Johnson & Son, Inc.**, Racine, WI  
(US)

(\*\*) Term: **14 Years**

(21) Appl. No.: **29/297,245**

(22) Filed: **Nov. 7, 2007**

**Related U.S. Application Data**

(62) Division of application No. 29/248,293, filed on Aug. 8, 2006.

(51) **LOC (8) Cl.** ..... **23-04**

(52) **U.S. Cl.** ..... **D23/364**

(58) **Field of Classification Search** ..... D23/364,  
D23/355, 356, 359, 360, 362, 352, 366, 369,  
D23/332, 333, 335, 336, 342; 422/120, 122;  
55/356, 473, 504; 210/497.1; 96/97; D14/188,  
D14/170, 172

See application file for complete search history.

(56) **References Cited**

**U.S. PATENT DOCUMENTS**

D326,318 S 5/1992 Coup et al. .... D23/335  
D384,734 S 10/1997 Ellwood ..... D23/335

D418,212 S	12/1999	TerMeer .....	D23/335
D418,591 S	1/2000	Birdsell et al. ....	D23/335
D426,876 S	6/2000	Rossmann et al. ....	D23/332
D432,222 S	10/2000	Rymer et al. ....	D23/366
D441,065 S	4/2001	Ediger et al. ....	D23/335
D457,614 S	5/2002	Chura et al. ....	D23/335
D462,428 S	9/2002	Chura et al. ....	D23/335
D468,627 S	1/2003	Dampney .....	D23/369
D471,969 S	3/2003	Krauss .....	D23/335
D509,892 S	9/2005	McLeish .....	D23/366
D538,415 S	3/2007	Ching .....	D23/335

*Primary Examiner*—Louis S Zarfaz  
*Assistant Examiner*—David G Muller

(57) **CLAIM**

The ornamental design for an air purifier, as shown and described.

**DESCRIPTION**

FIG. 1 is an isometric view of the air purifier of the present invention;

FIG. 2 is a front elevation view of the air purifier of FIG. 1;

FIG. 3 is a right side elevational view of the air purifier of FIG. 1, the left side being a mirror image thereof;

FIG. 4 is a top plan view of the air purifier of FIG. 1;

FIG. 5 is a rear elevational view of the air purifier of FIG. 1; and,

FIG. 6 is a bottom plan view of the air purifier of FIG. 1.

**1 Claim, 6 Drawing Sheets**

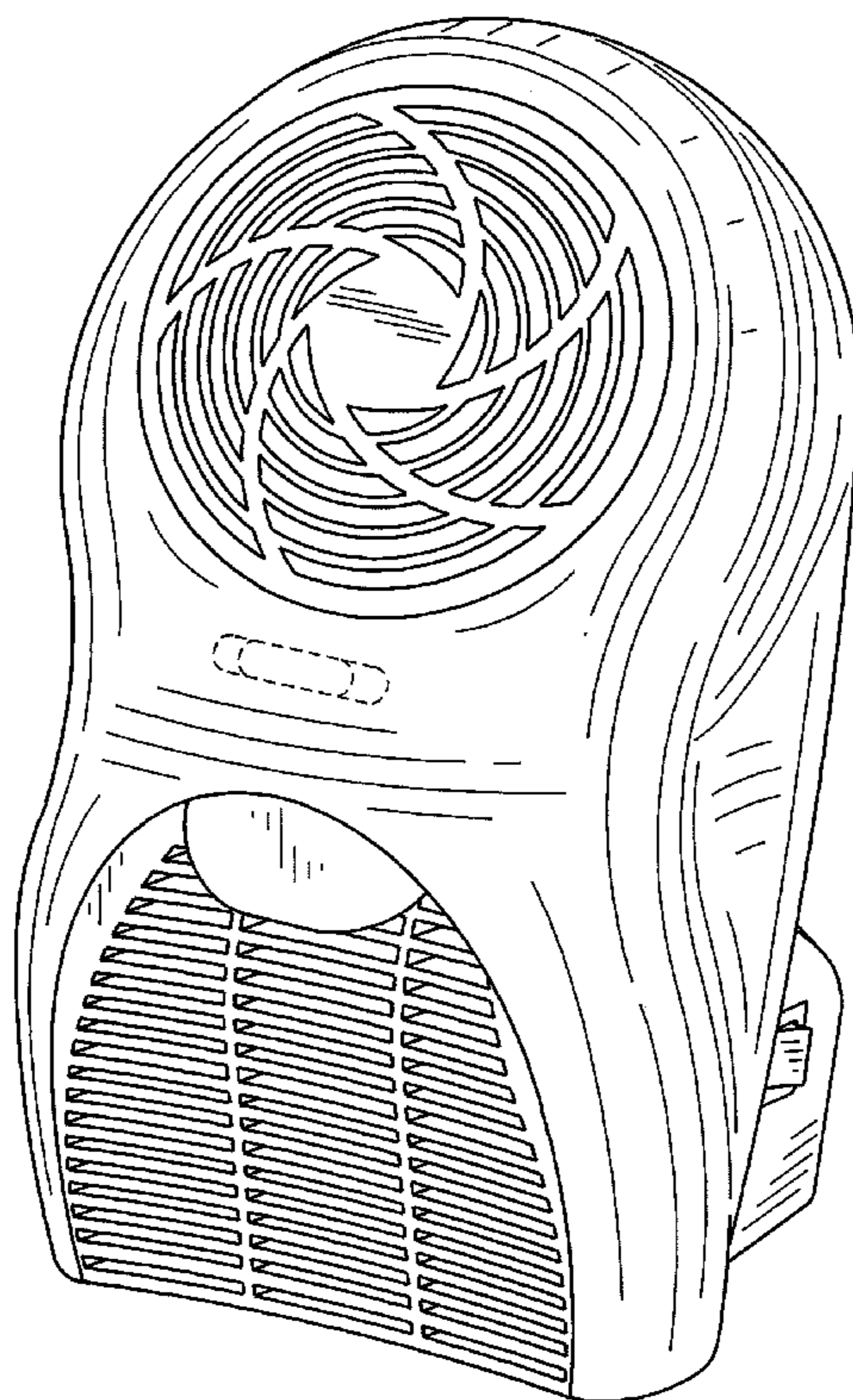

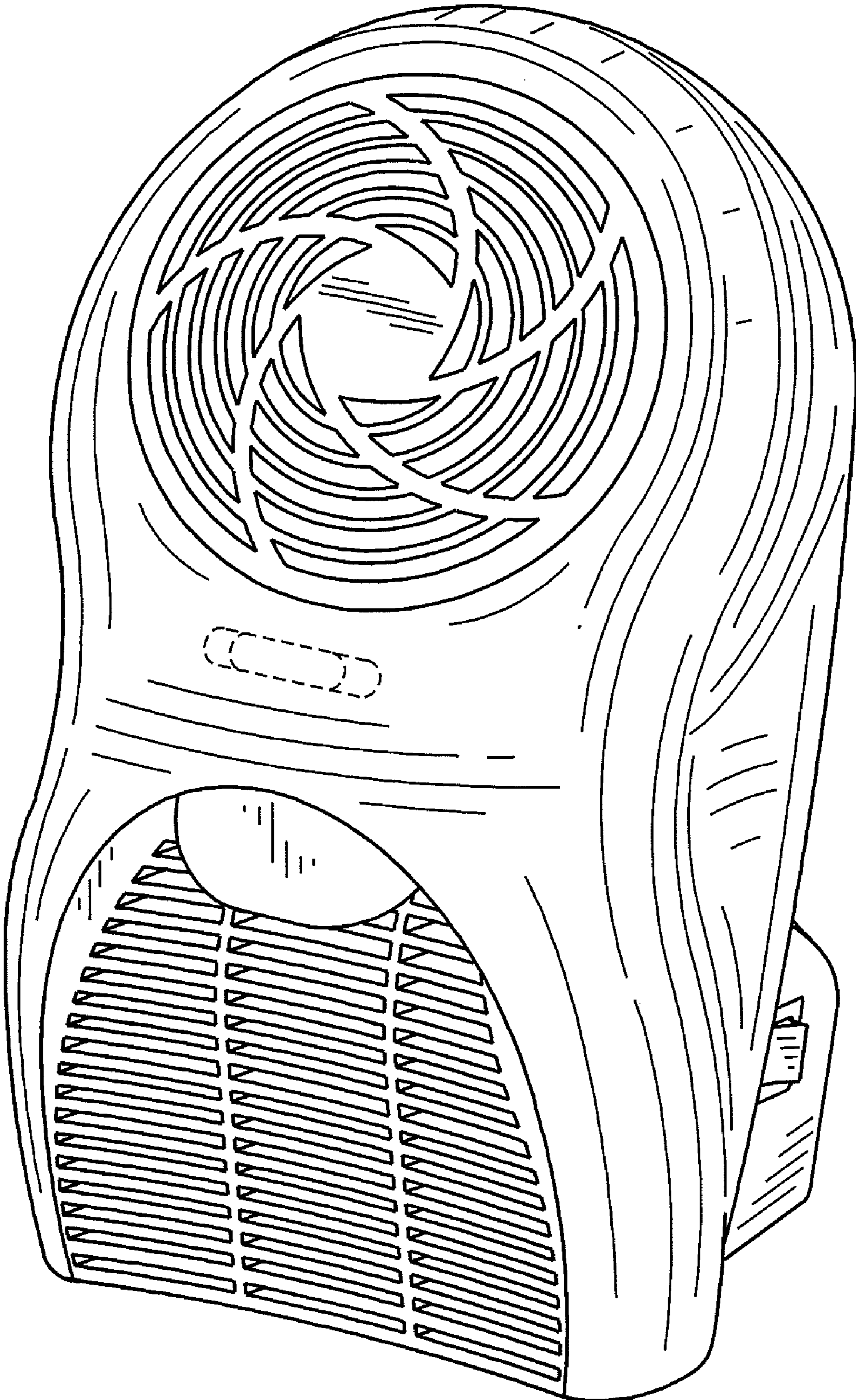

FIG. 1

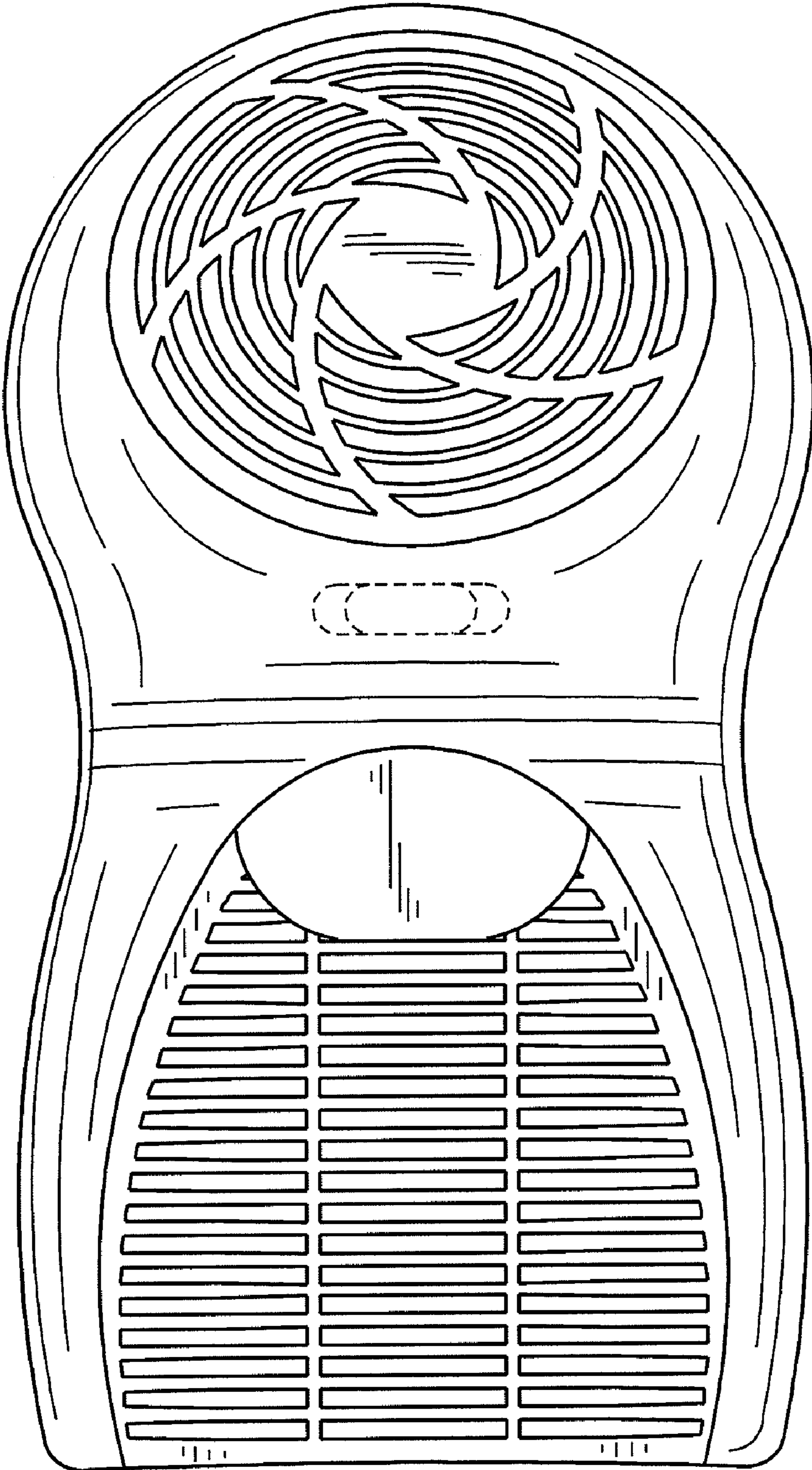

FIG. 2

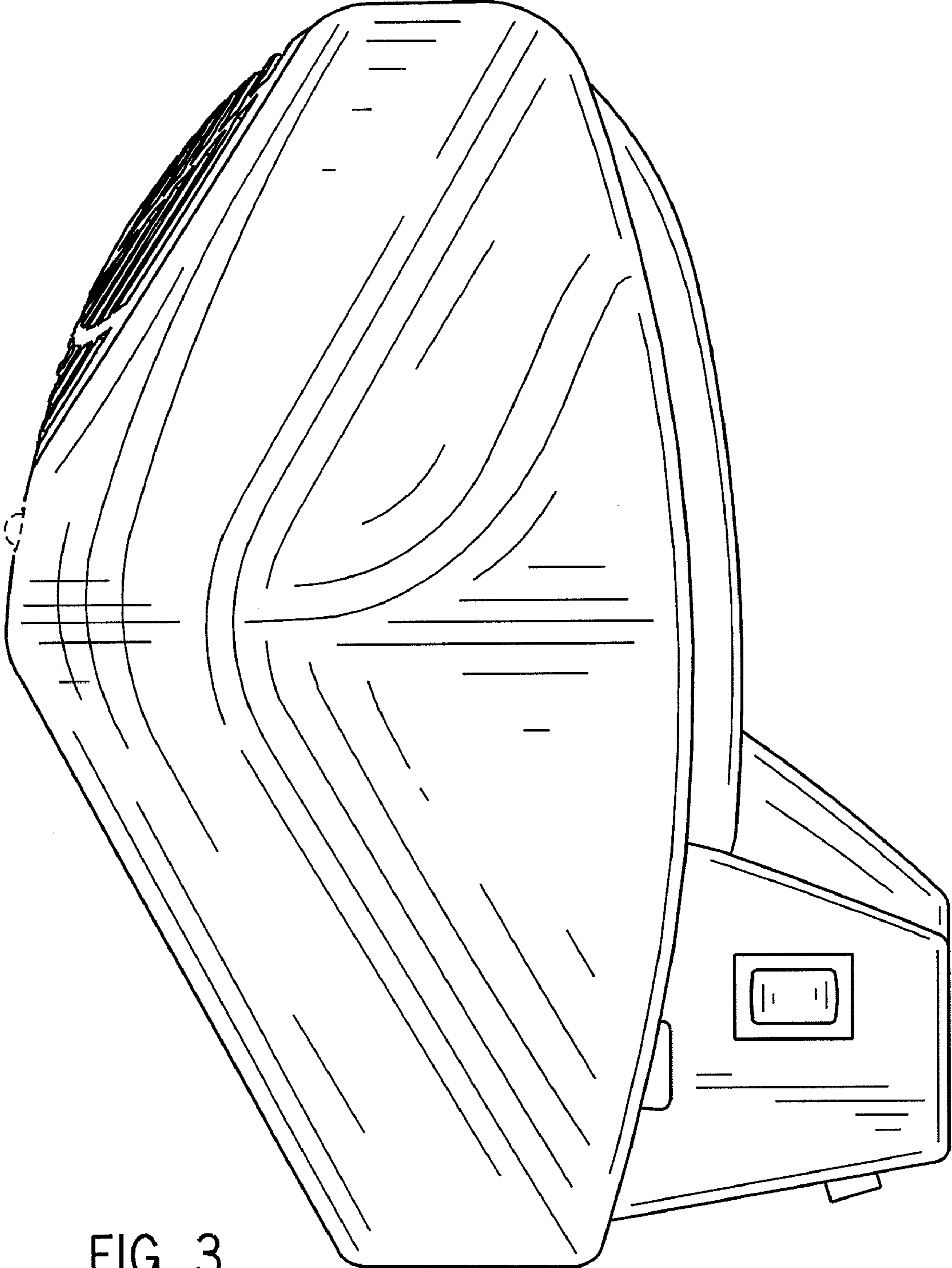

FIG. 3

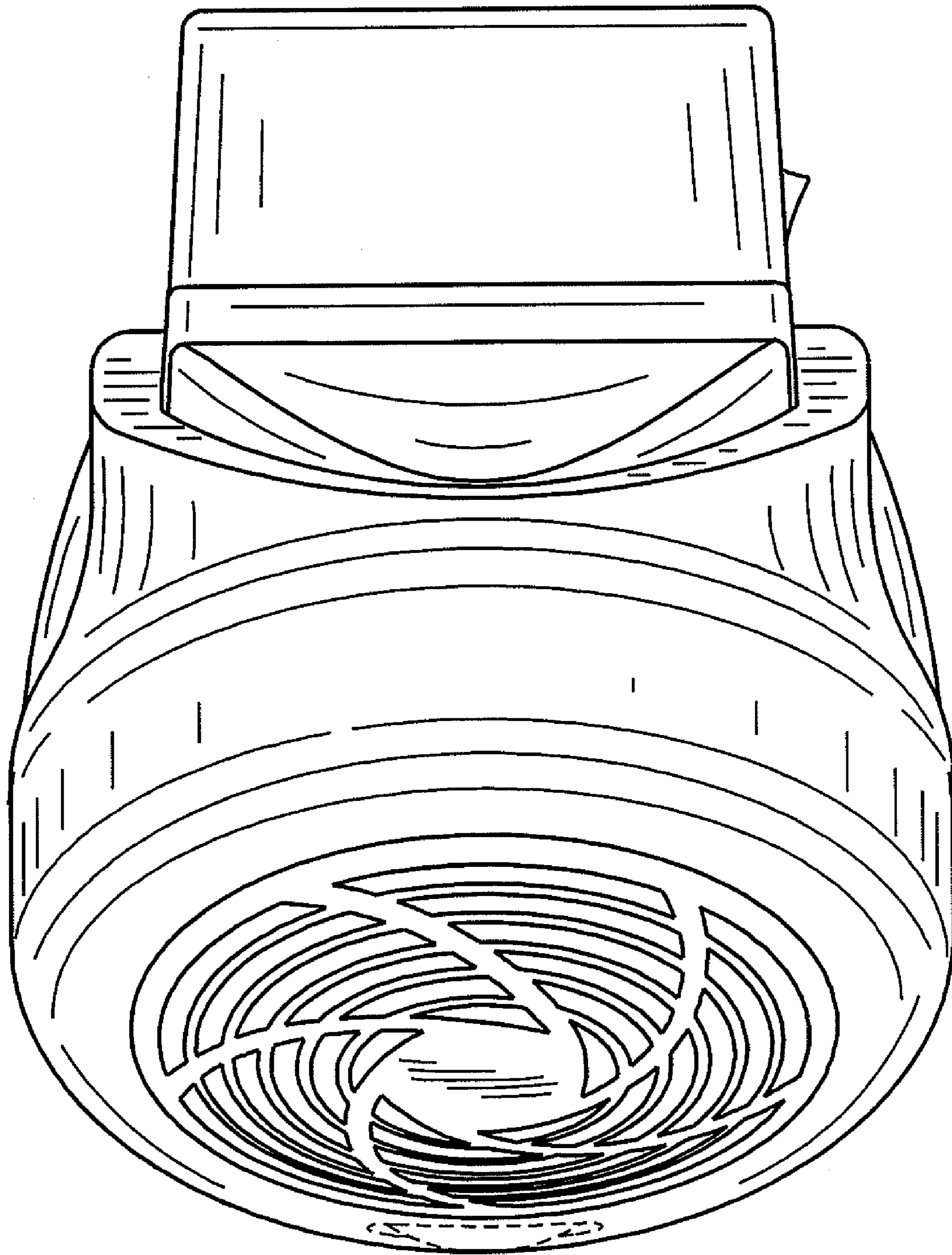

FIG. 4

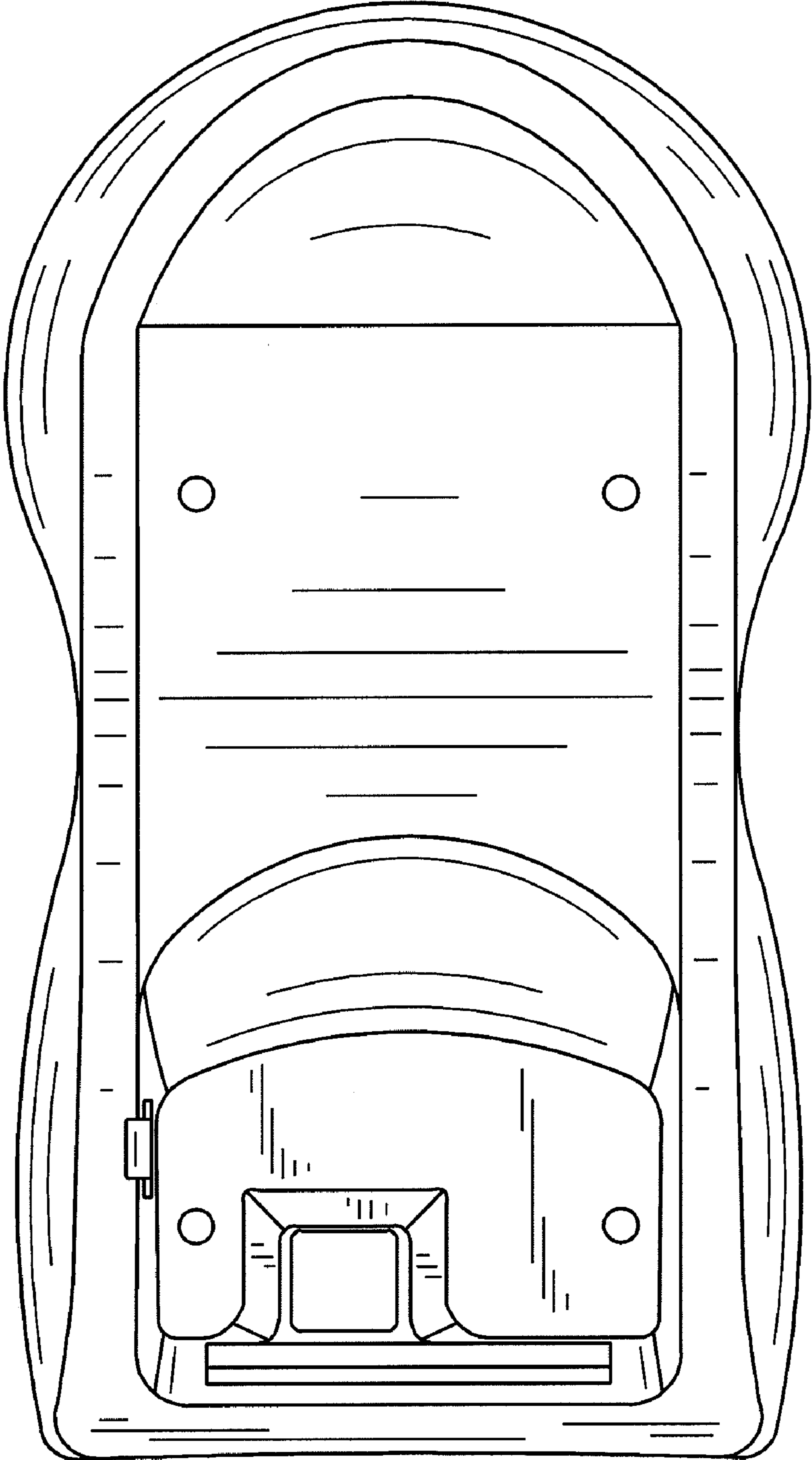

FIG. 5

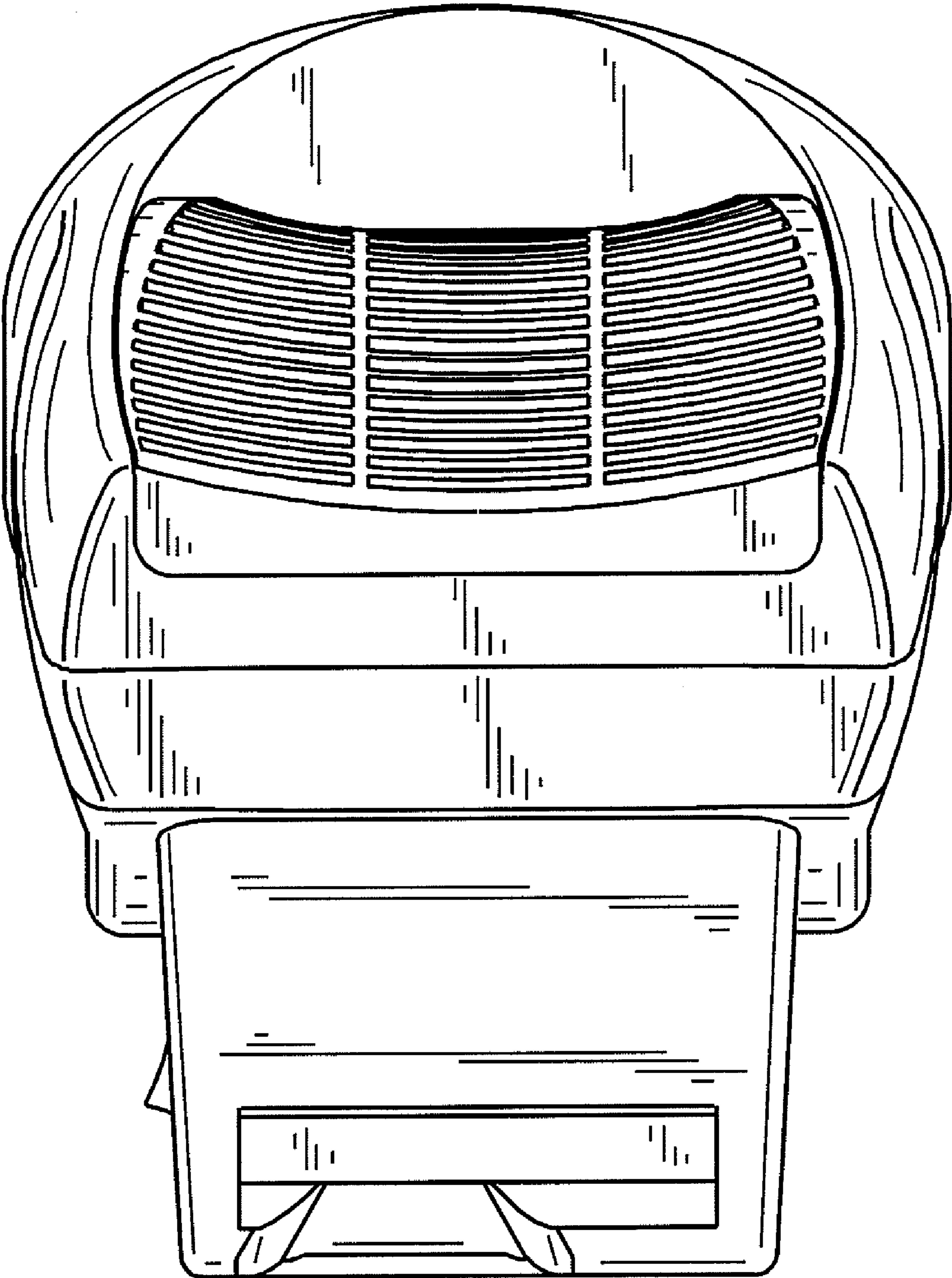

FIG. 6