



US00D577707S

(12) **United States Design Patent**
Lee et al.

(10) **Patent No.:** **US D577,707 S**
(45) **Date of Patent:** **** Sep. 30, 2008**

(54) **PORTABLE TRANSLATION MACHINE**

(75) Inventors: **Dong-Kyu Lee**, Yongin-si (KR);
Sung-Jin Ann, Seoul (KR)

(73) Assignee: **Samsung Electronics Co., Ltd.**,
Suwon-Si (KR)

(**) Term: **14 Years**

(21) Appl. No.: **29/290,715**

(22) Filed: **Jan. 4, 2008**

(51) **LOC (8) Cl.** **14-99**

(52) **U.S. Cl.** **D14/158; D14/167**

(58) **Field of Classification Search** D14/167,
D14/154, 168, 188, 496, 156, 160, 161, 162,
D14/163, 164, 165, 158; D16/208; D26/38;
455/351, 350

See application file for complete search history.

(56) **References Cited**

U.S. PATENT DOCUMENTS

D167,828	S	*	9/1952	Florac	D14/194
3,165,991	A	*	1/1965	Yoshida	396/434
D302,544	S	*	8/1989	Spira	D13/168
D306,853	S	*	3/1990	Mayo et al.	D13/168
D398,605	S	*	9/1998	Murray et al.	D14/137
D496,003	S	*	9/2004	Spira	D13/168
D500,301	S	*	12/2004	Deguchi	D14/167
D506,471	S	*	6/2005	Iikura et al.	D14/474

D512,043	S	*	11/2005	Yagi	D14/167
D552,586	S	*	10/2007	Kim	D14/138
D556,154	S	*	11/2007	Poulet et al.	D13/168
D560,617	S	*	1/2008	Poulet	D13/158
D563,954	S	*	3/2008	Buchanon	D14/356

* cited by examiner

Primary Examiner—Cathron Brooks

Assistant Examiner—Austin Murphy

(74) *Attorney, Agent, or Firm*—Staas & Halsey LLP

(57) **CLAIM**

The ornamental design for a portable translation machine, as shown and described.

DESCRIPTION

FIG. 1 is a perspective view of a portable translation machine according to our new design;

FIG. 2 is a front elevational view thereof;

FIG. 3 is a rear elevational view thereof;

FIG. 4 is a left side elevational view thereof;

FIG. 5 is a right side elevational view thereof;

FIG. 6 is a top plan view thereof;

FIG. 7 is a bottom plan view thereof; and,

FIG. 8 is a perspective view of the portable translation machine according to our new design in a state in which the portable translation machine is rotating when used.

1 Claim, 6 Drawing Sheets

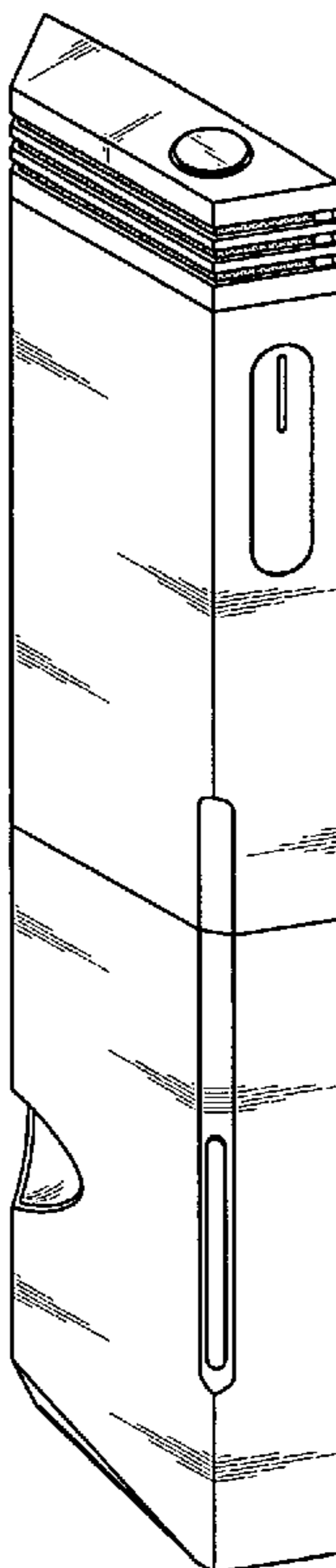

FIG. 1

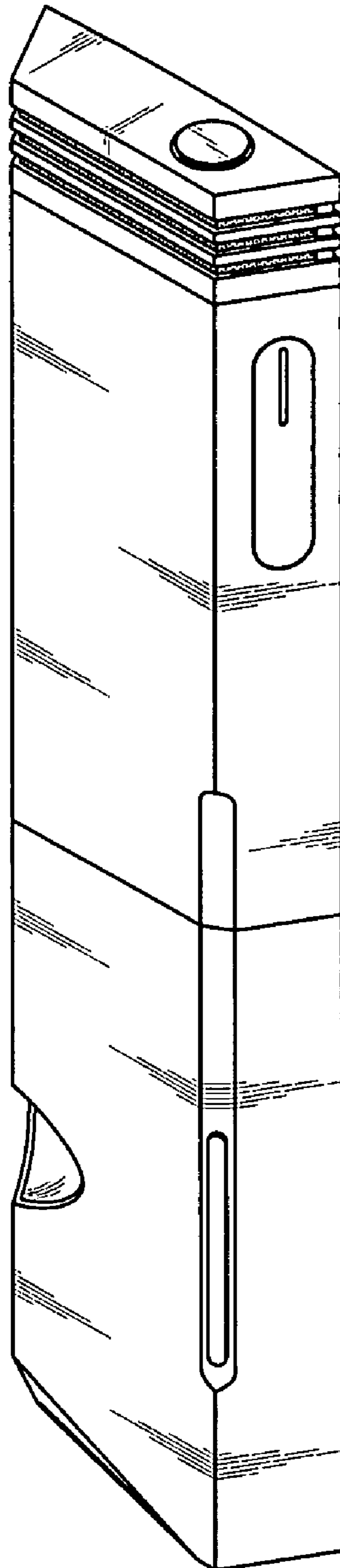

FIG. 2

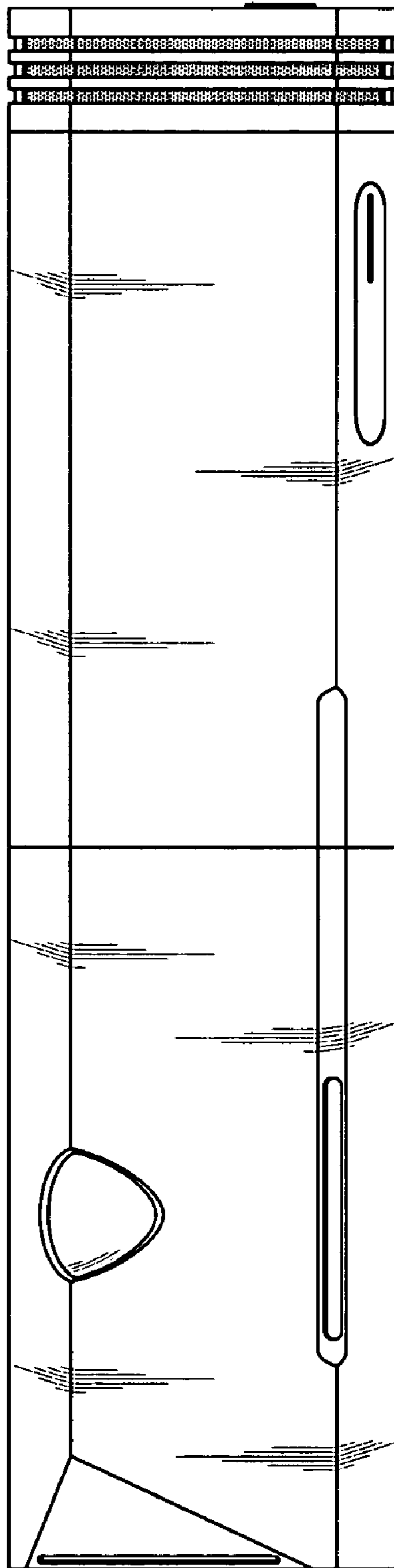

FIG. 3

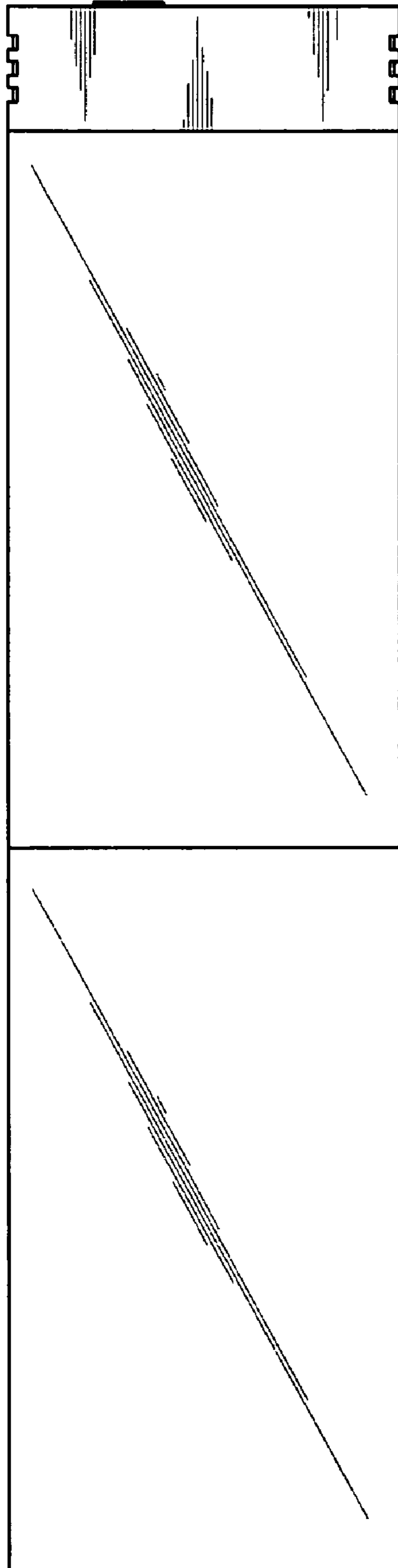

FIG. 4

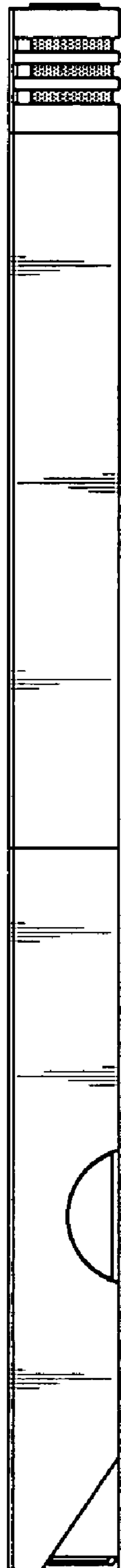

FIG. 5

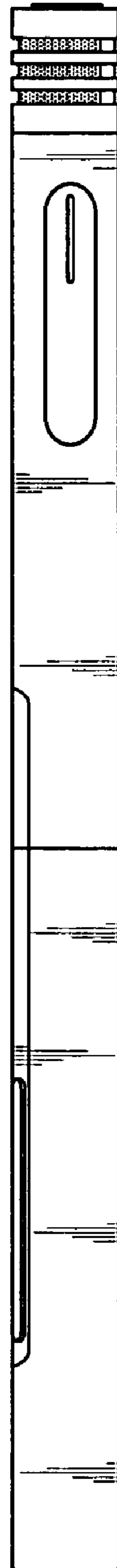

FIG. 6

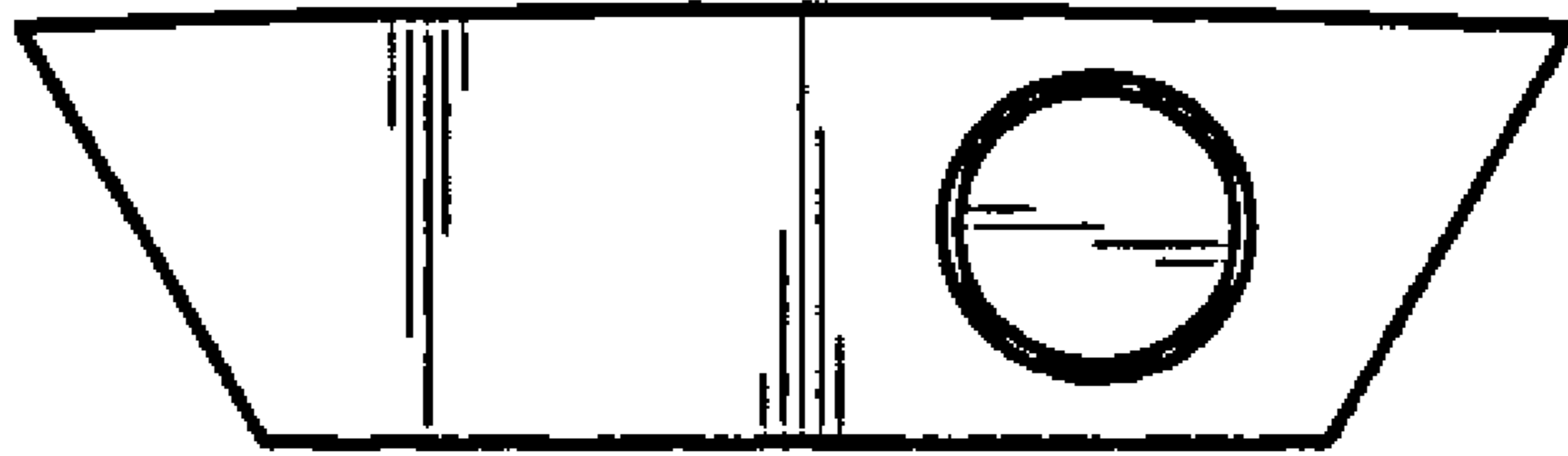

FIG. 7

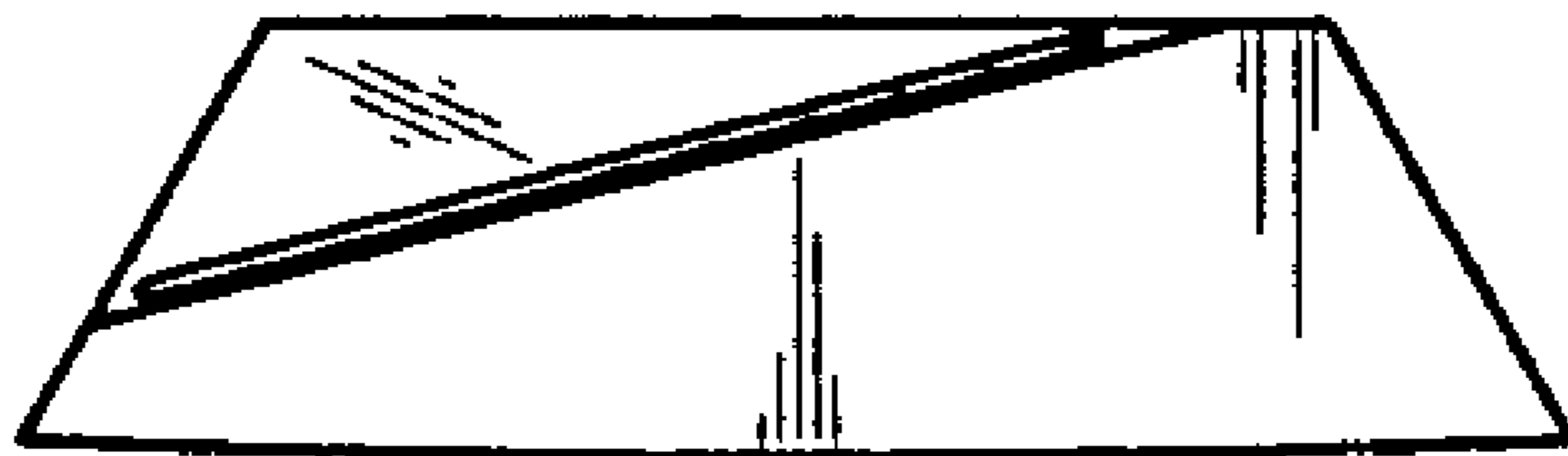

FIG. 8

