



US00D577701S

(12) **United States Design Patent**
Oh et al.

(10) **Patent No.:** **US D577,701 S**
(45) **Date of Patent:** **** Sep. 30, 2008**

(54) **HANDSET**

(75) Inventors: **Christine Oh**, Los Angeles, CA (US);
Jonathan Dry, Newbury Park, CA (US);
Dimitre D. Mehandjiysky, Belmont
Shore, CA (US)

(73) Assignee: **Nokia Corporation**, Espoo (FI)

(**) Term: **14 Years**

(21) Appl. No.: **29/246,355**

(22) Filed: **Apr. 3, 2006**

(51) **LOC (8) Cl.** **14-03**

(52) **U.S. Cl.** **D14/138**

(58) **Field of Classification Search** D14/496,
D14/138, 341-347; 455/575.3, 575.1; D21/517,
D21/329, 333

See application file for complete search history.

(56) **References Cited**

U.S. PATENT DOCUMENTS

D477,296 S * 7/2003 Minamide D14/138
(Continued)

FOREIGN PATENT DOCUMENTS

JP D1188710 * 10/2003
(Continued)

OTHER PUBLICATIONS

Asus M307 telephone, announced Mar. 2006, [online], [site visited
Oct. 25, 2007]. Available from Internet ,<URL: <http://www.gsmarena.com>>.*

(Continued)

Primary Examiner—Jeffrey D Asch
(74) *Attorney, Agent, or Firm*—Banner & Witcoff, Ltd.

(57) **CLAIM**

The ornamental design for a handset, as shown and described.

DESCRIPTION

FIG. 1 is a bottom plan view of a first embodiment of a handset showing our new design;

FIG. 2 is a right side view thereof;

FIG. 3 is a front view thereof;

FIG. 4 is a left side view thereof;

FIG. 5 is a top plan view thereof;

FIG. 6 is a rear view thereof;

FIG. 7 is a perspective front view thereof;

FIG. 8 is a perspective rear view thereof;

FIG. 9 is a front view of the handset of FIGS. 1-8 in an in-use open position;

FIG. 10 is a perspective front view of the handset of FIGS. 1-8 in an in-use open position;

FIG. 11 is a bottom plan view of a second embodiment of a handset showing our new design;

FIG. 12 is a right side view thereof;

FIG. 13 is a front view thereof;

FIG. 14 is a left side view thereof;

FIG. 15 is a top plan view thereof;

FIG. 16 is a rear view thereof;

FIG. 17 is a perspective front view thereof;

FIG. 18 is a perspective rear view thereof;

FIG. 19 is a front view of the handset of FIGS. 11-18 in an in-use open position;

FIG. 20 is a perspective view of the handset of FIGS. 11-18 in an in-use open position;

FIG. 21 is a perspective front view of a third embodiment of a handset showing our new design having interior surfaces as shown in the in-use position in FIGS. 19-20, including the key button area; and,

FIG. 22 is a front view thereof.

The third embodiment of the handset shown in FIGS. 21 and 22 has the identical bottom plan view, left side view, right side view, top plan view, and rear view of the handset shown in FIGS. 11-20.

The broken line showing of the environmental structure is for illustrative purposes only and forms no part of the claimed design.

1 Claim, 12 Drawing Sheets

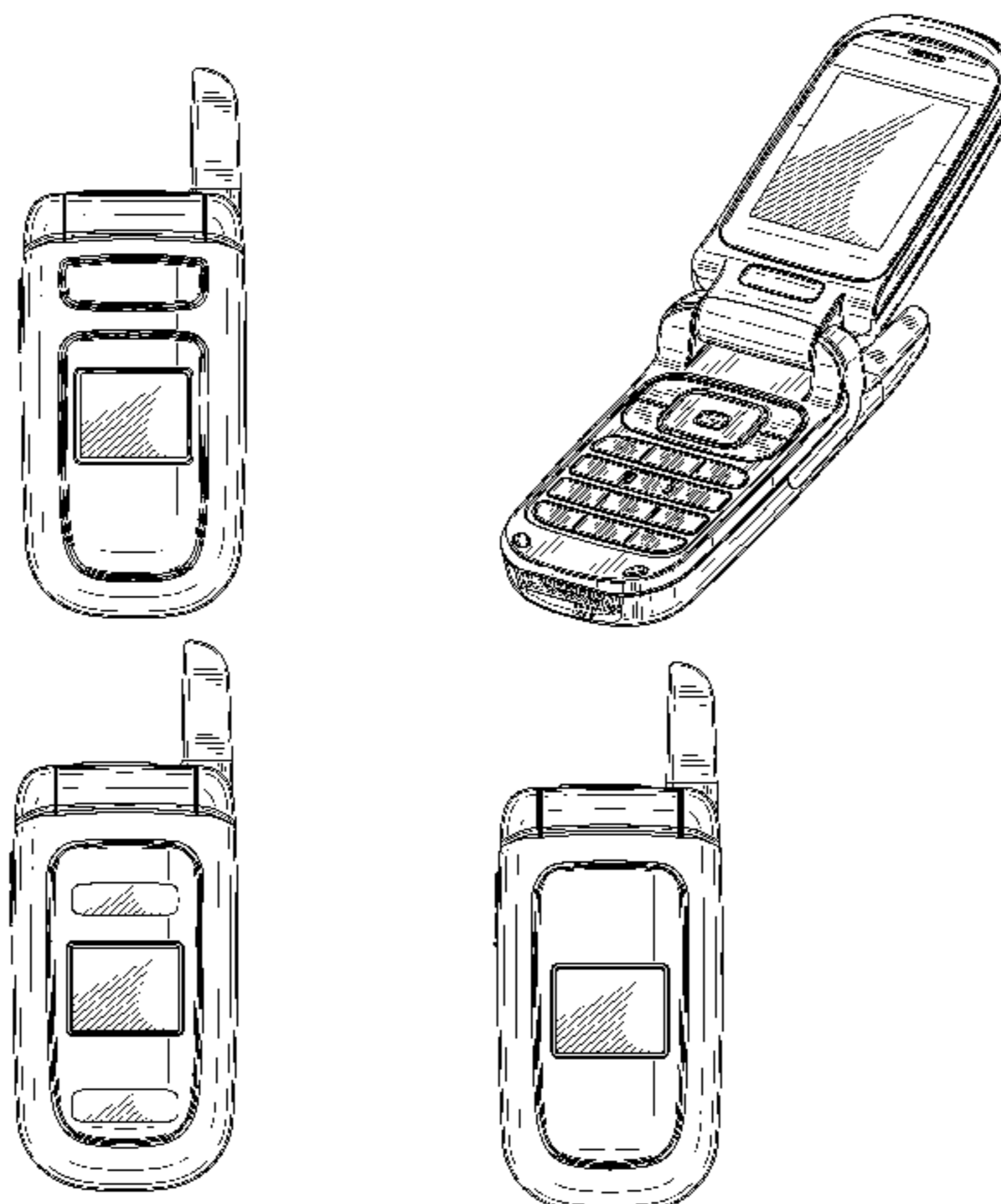

U.S. PATENT DOCUMENTS

D485,818	S	*	1/2004	Yabe et al.	D14/138
D487,443	S	*	3/2004	Yoon	D14/138
D487,444	S	*	3/2004	Yoon	D14/138
D496,347	S	*	9/2004	Choi et al.	D14/191
D499,390	S	*	12/2004	Cho	D14/138
D500,016	S	*	12/2004	Kim	D14/138
D501,190	S	*	1/2005	Watanabe et al.	D14/138
D506,454	S	*	6/2005	Kim et al.	D14/138
D510,733	S	*	10/2005	Lee et al.	D14/138
D512,396	S	*	12/2005	Kim et al.	D14/138
D513,505	S	*	1/2006	Lee	D14/138
D518,465	S	*	4/2006	Van Den Nieuwenhuizen et al.	D14/138
D519,479	S	*	4/2006	Koo et al.	D14/138
D522,991	S	*	6/2006	Yun et al.	D14/138
D535,635	S	*	1/2007	Hwang et al.	D14/138
D536,686	S	*	2/2007	Miyata	D14/138
D537,061	S	*	2/2007	Oh	D14/138
D537,428	S	*	2/2007	Fahlgren	D14/138
D537,429	S	*	2/2007	Fahlgren	D14/138
D542,770	S	*	5/2007	Bower	D14/138
D545,288	S	*	6/2007	Chung et al.	D14/138
D546,312	S	*	7/2007	Han et al.	D14/138
D552,576	S	*	10/2007	Kim et al.	D14/138
D552,577	S	*	10/2007	Kim et al.	D14/138
2002/0197965	A1	*	12/2002	Peng	455/90
2006/0121961	A1	*	6/2006	Cho	455/575.3

FOREIGN PATENT DOCUMENTS

WO	DM/067481	*	12/2005
WO	DM/068012	*	7/2006

WO DM/068074 * 7/2006

OTHER PUBLICATIONS

Nokia 6133 telephone, announced Oct. 2006, [online], [site visited Oct. 25, 2007]. Available from Internet ,<URL: <http://www.gsmarena.com>>.*

Samsung Z600 telephone, announced Feb. 2006, [online], [site visited Oct. 25, 2007]. Available from Internet ,<URL: <http://www.gsmarena.com>>.*

Sony Ericsson Z525 telephone, announced Apr. 2006, [online], [site visited Oct. 25, 2007]. Available from Internet ,<URL: <http://www.gsmarena.com>>.*

BenQ-Siemens CF61 telephone, announced Mar. 2006, [online], [site visited Oct. 25, 2007]. Available from Internet ,<URL: <http://www.gsmarena.com>>.*

Sharp GX30 telephone, announced 1st quarter 2004, [online], [site visited Oct. 25, 2007]. Available from Internet ,<URL: <http://www.gsmarena.com>>.*

Nokia Model #6030, 1 color sheet of photographs, date unknown but prior to filing of present application.

Nokia Model #6060, 3 color sheets of photographs, published Jun. 2005.

Nokia Model #6103, 3 color sheets of photographs, date unknown but prior to filing of present application.

Nokia Model #6136, 1 color sheet of photographs, published Feb. 2006.

Nokia Model #6131, 2 color sheets of photographs, published Feb. 2006.

Nokia Model #6126, 1 color sheet of photographs, date unknown but prior to filing of present application.

* cited by examiner

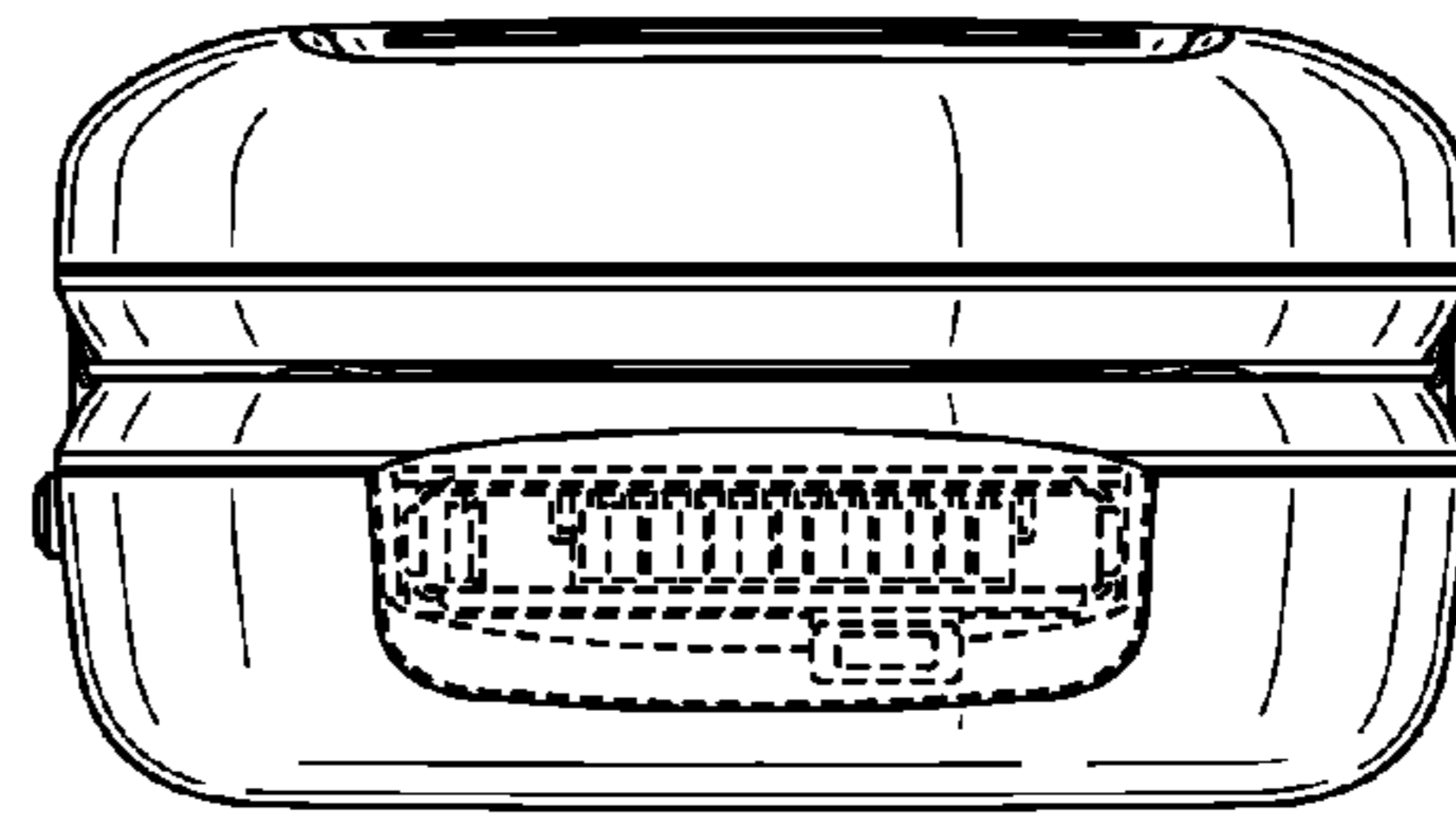

FIG. 1

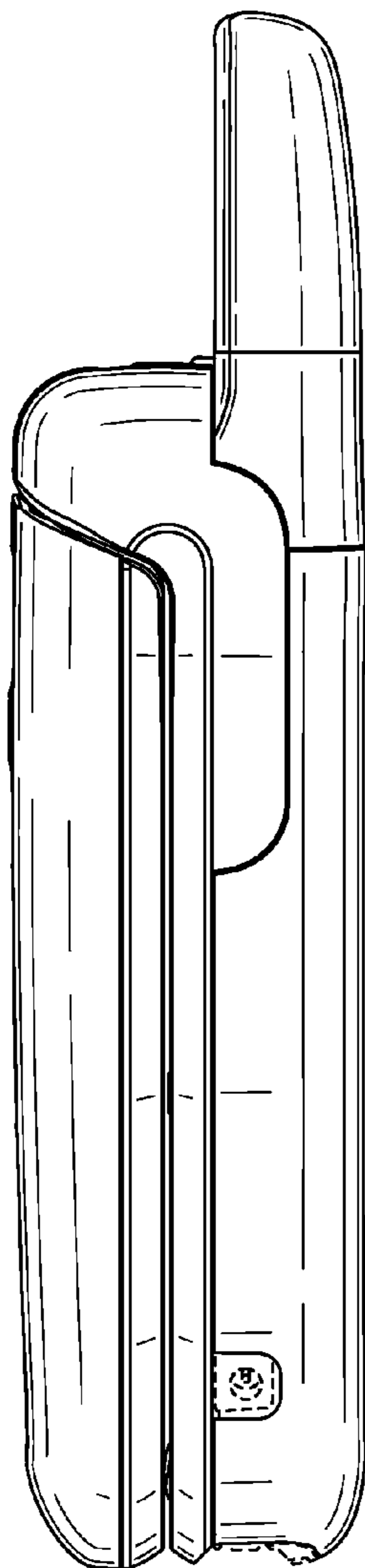

FIG. 2

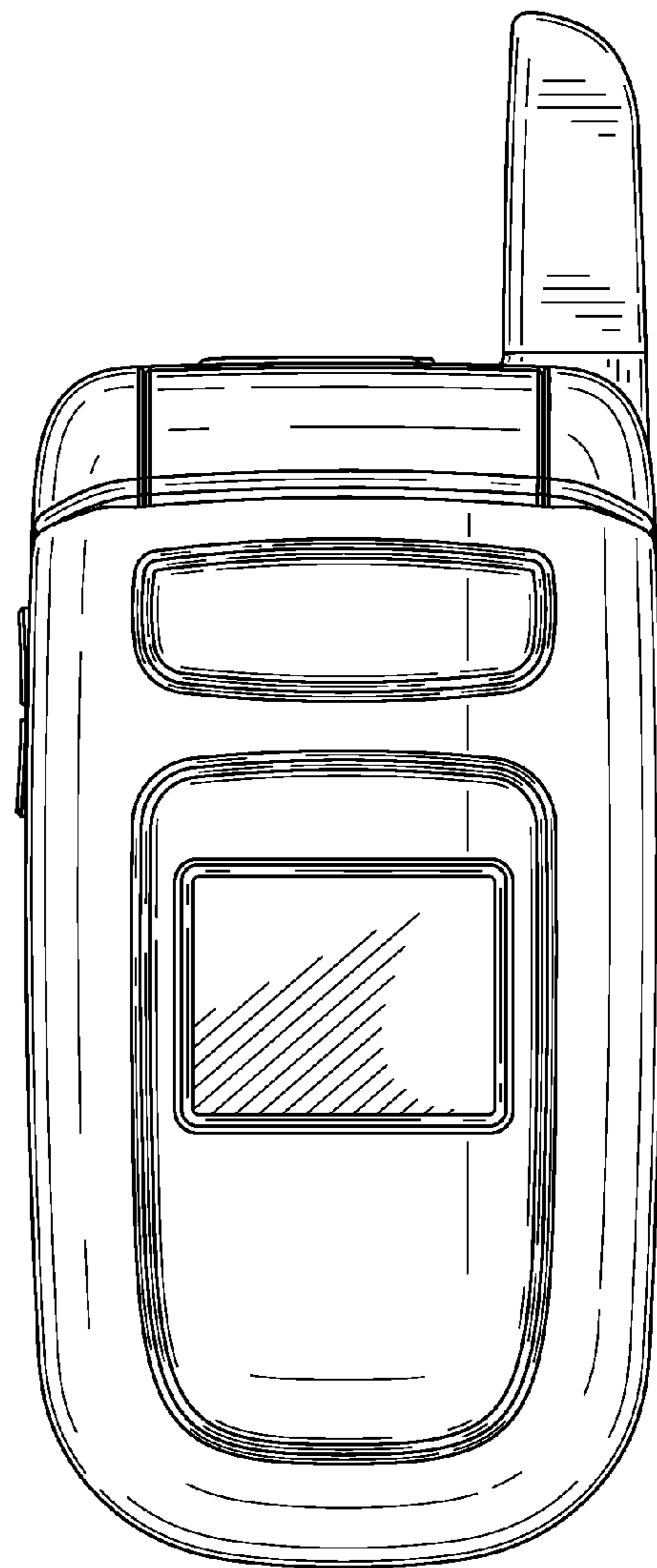

FIG. 3

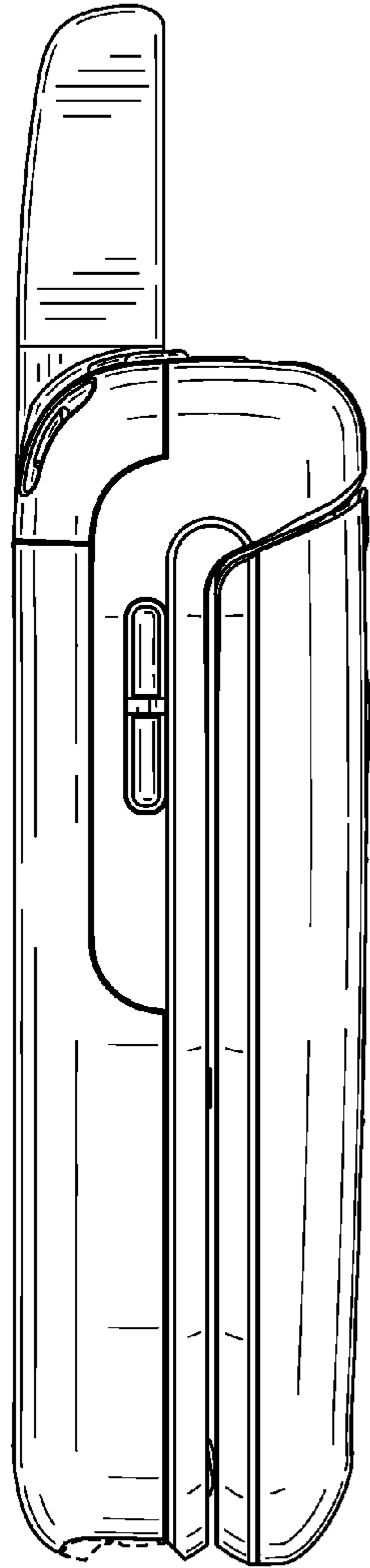

FIG. 4

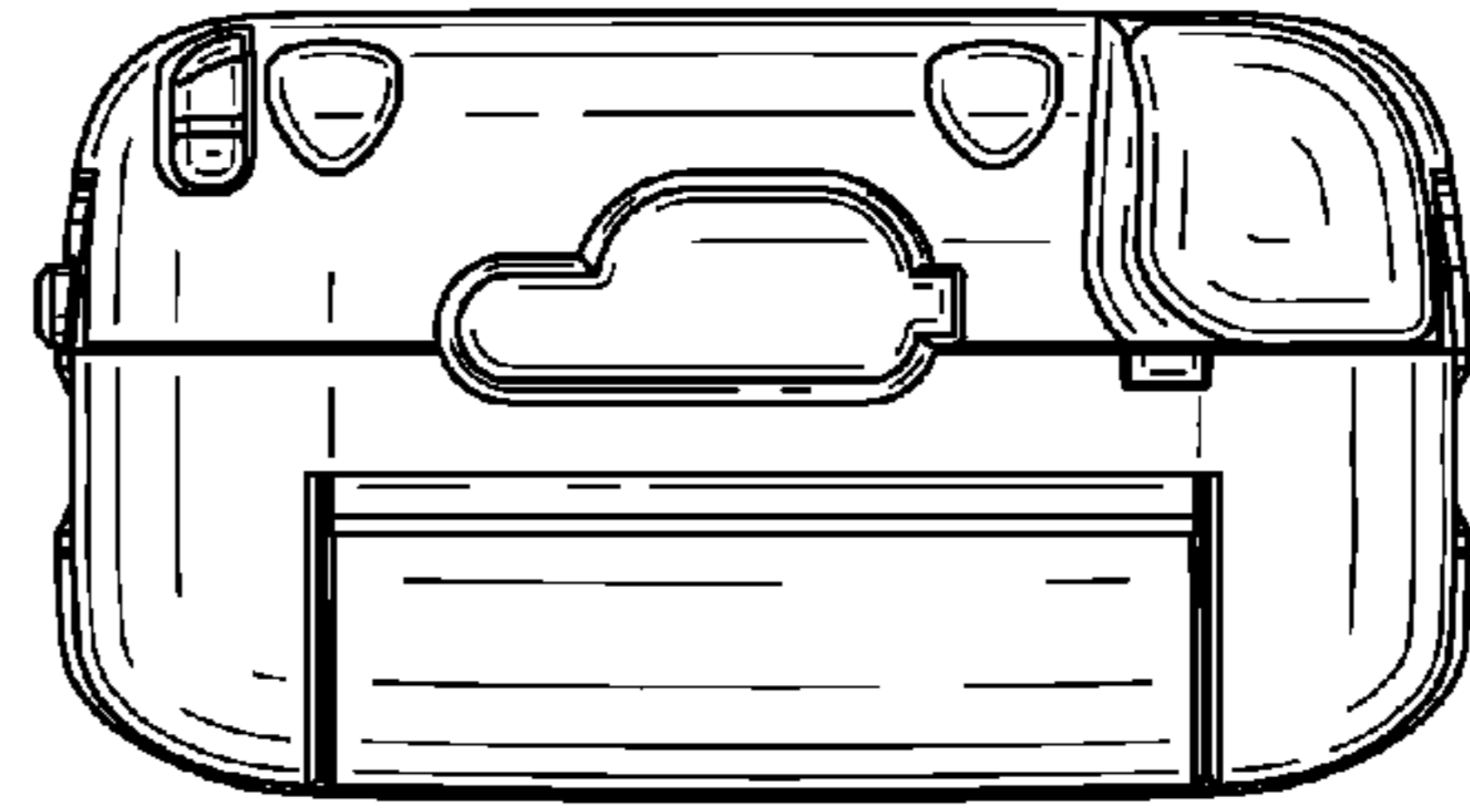

FIG. 5

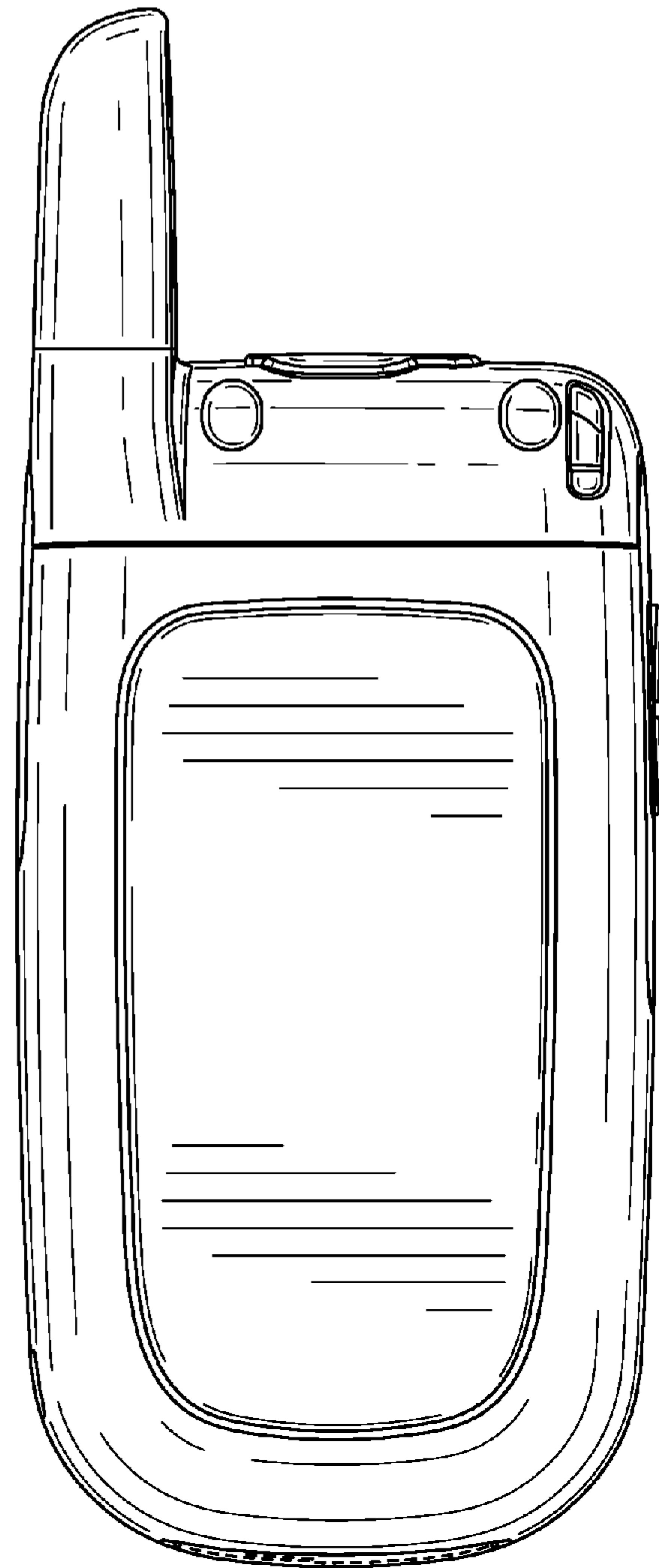

FIG. 6

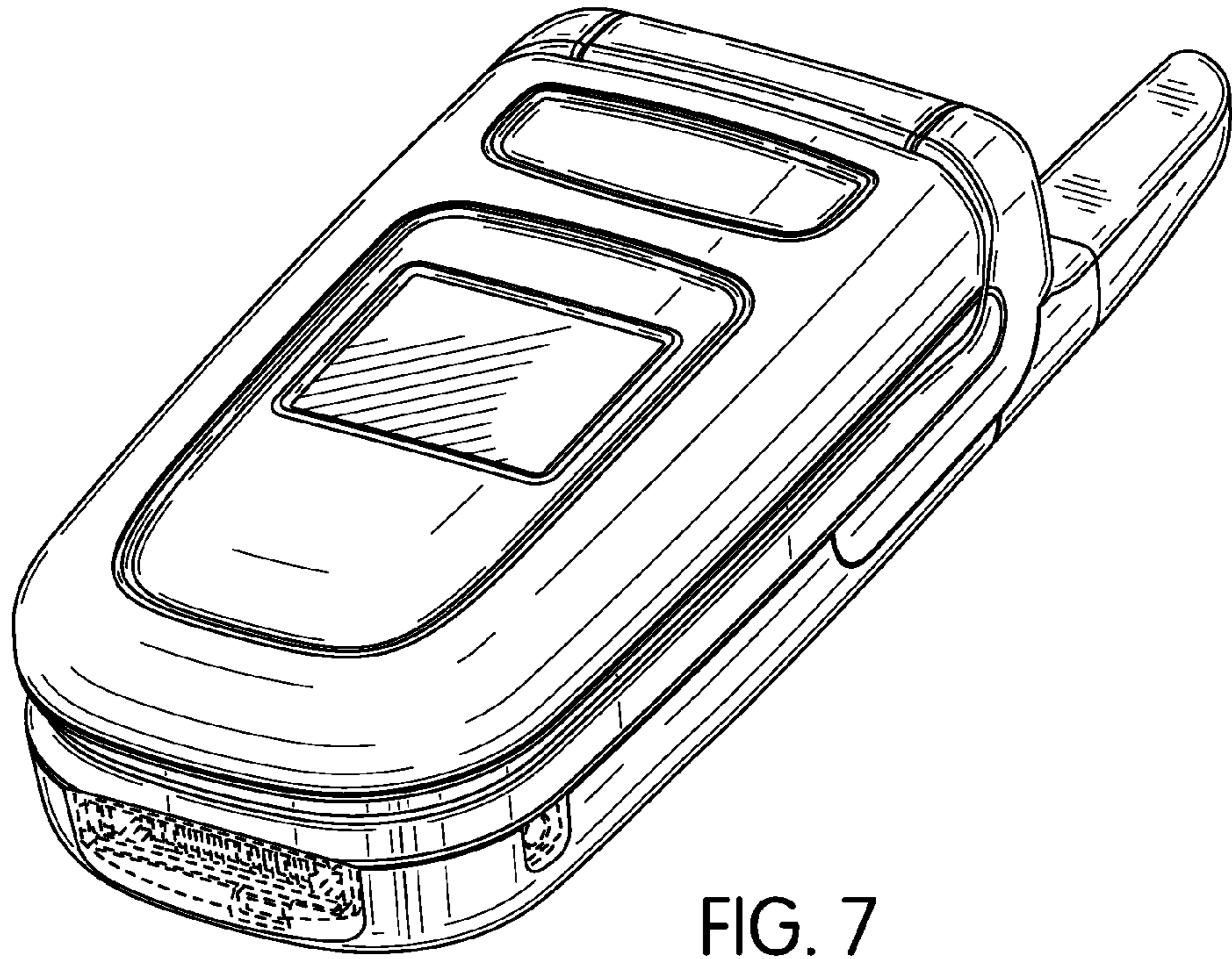

FIG. 7

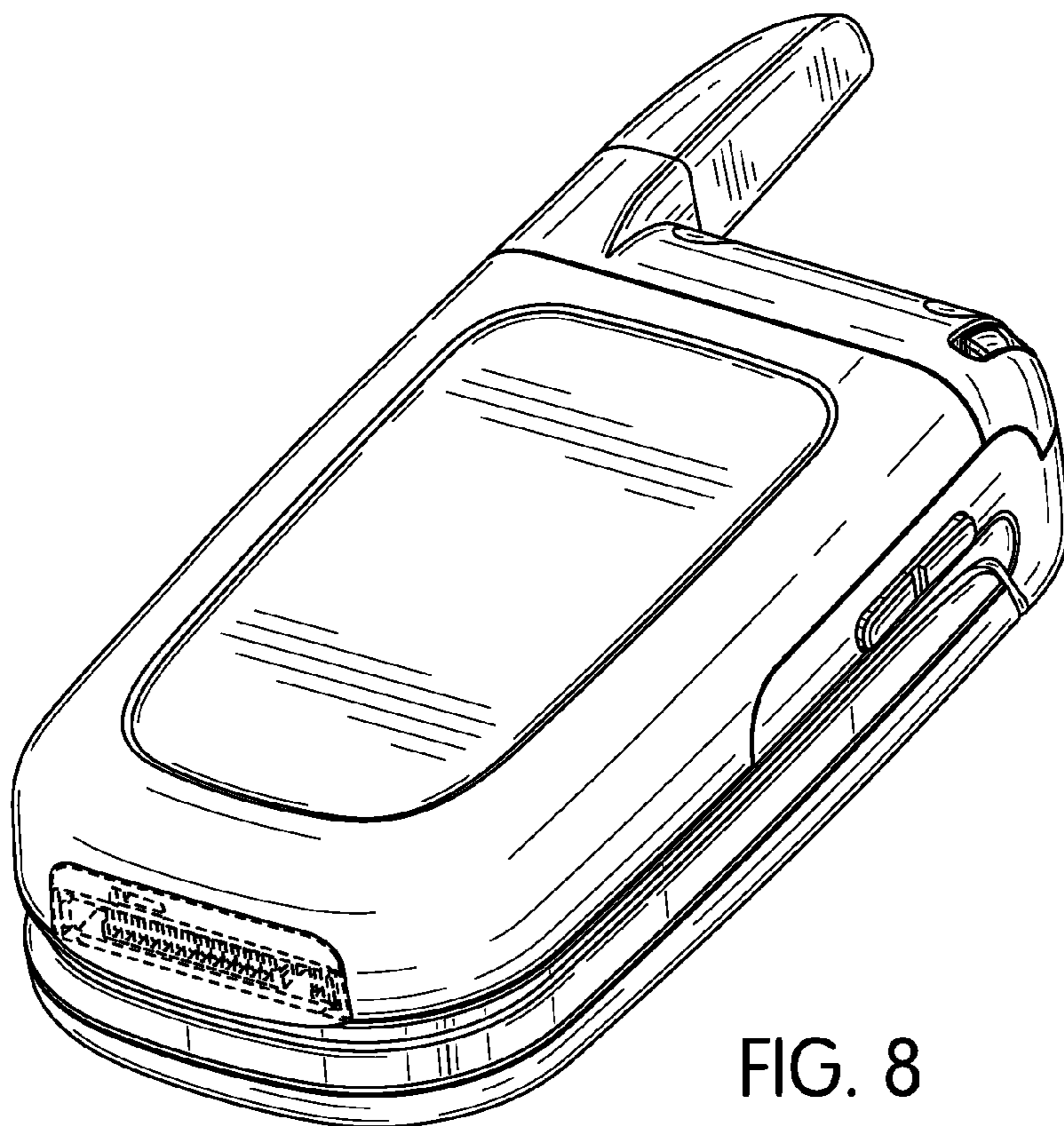

FIG. 8

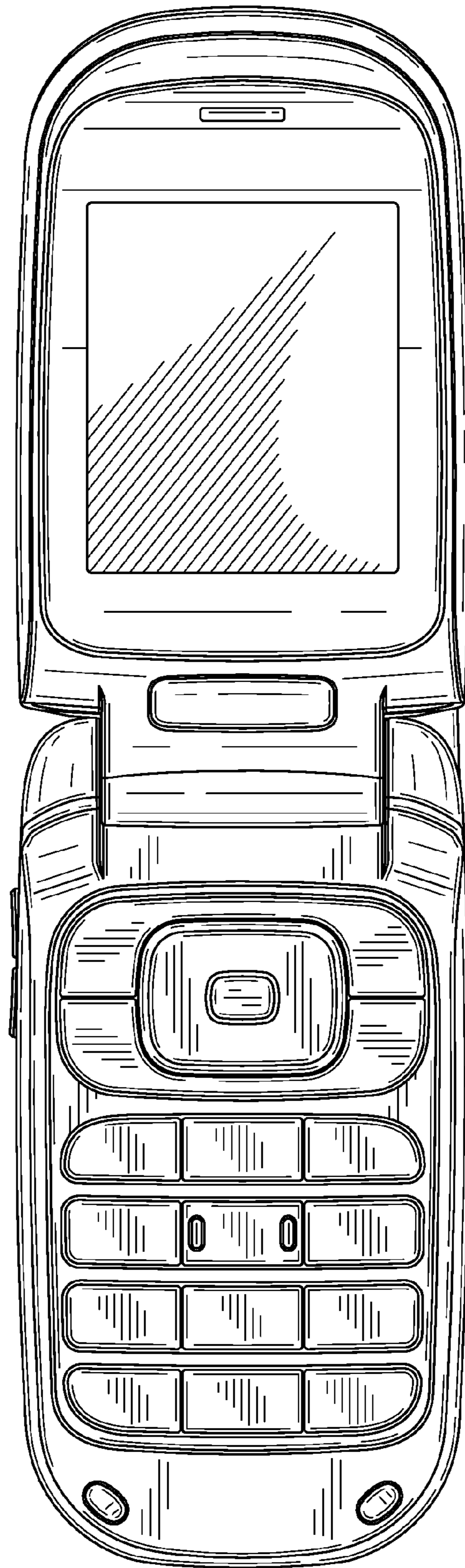

FIG. 9



FIG. 10

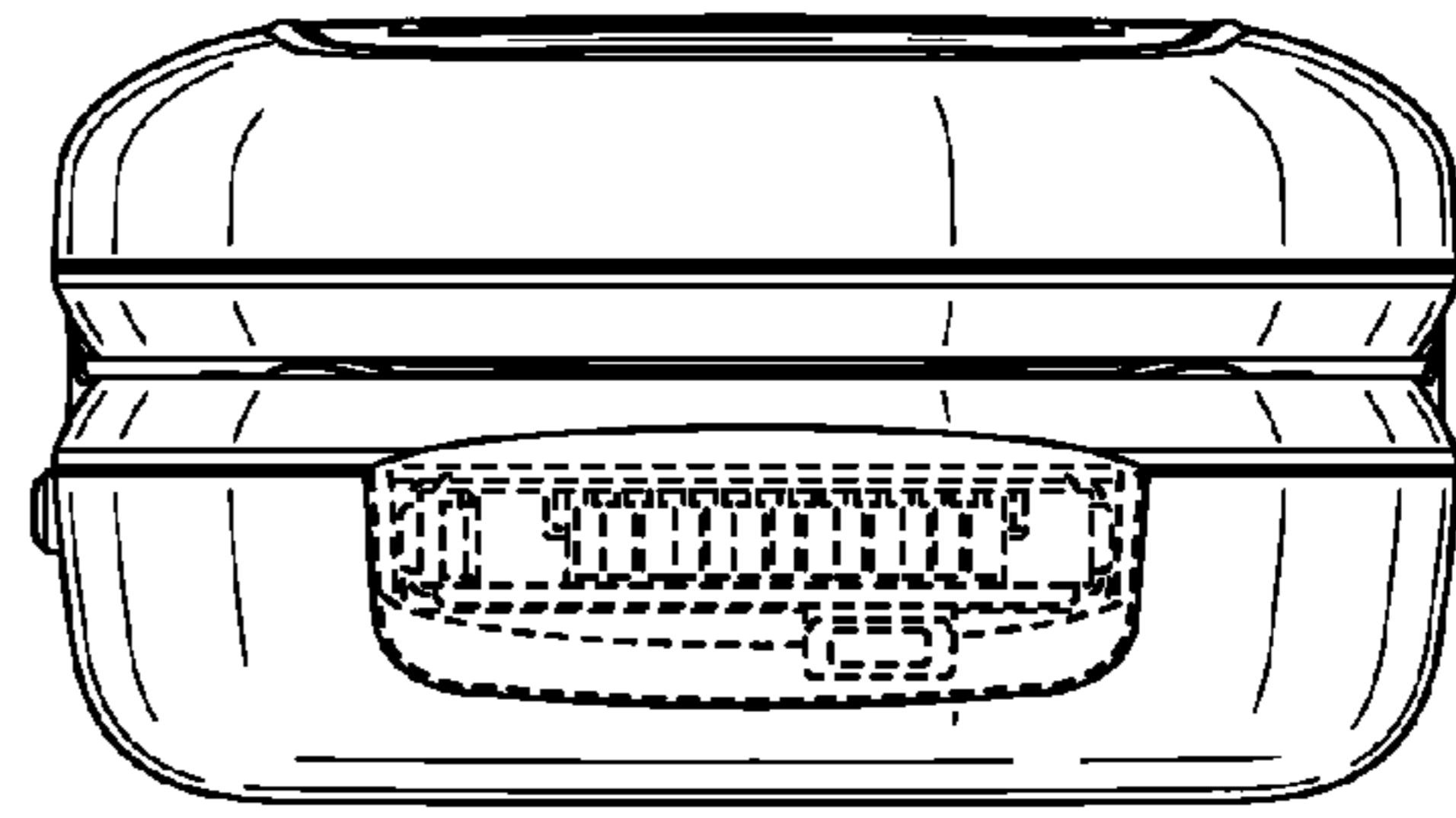

FIG. 11

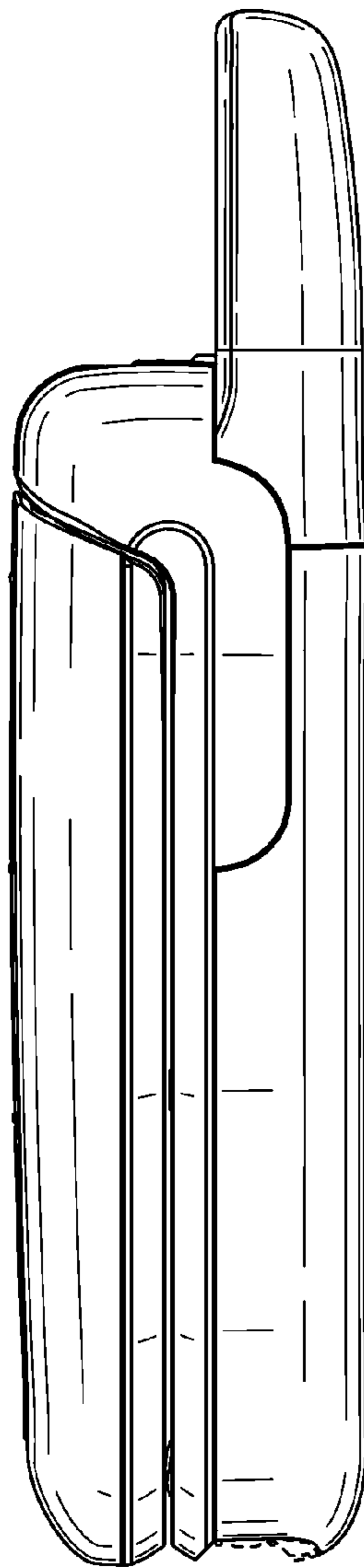

FIG. 12

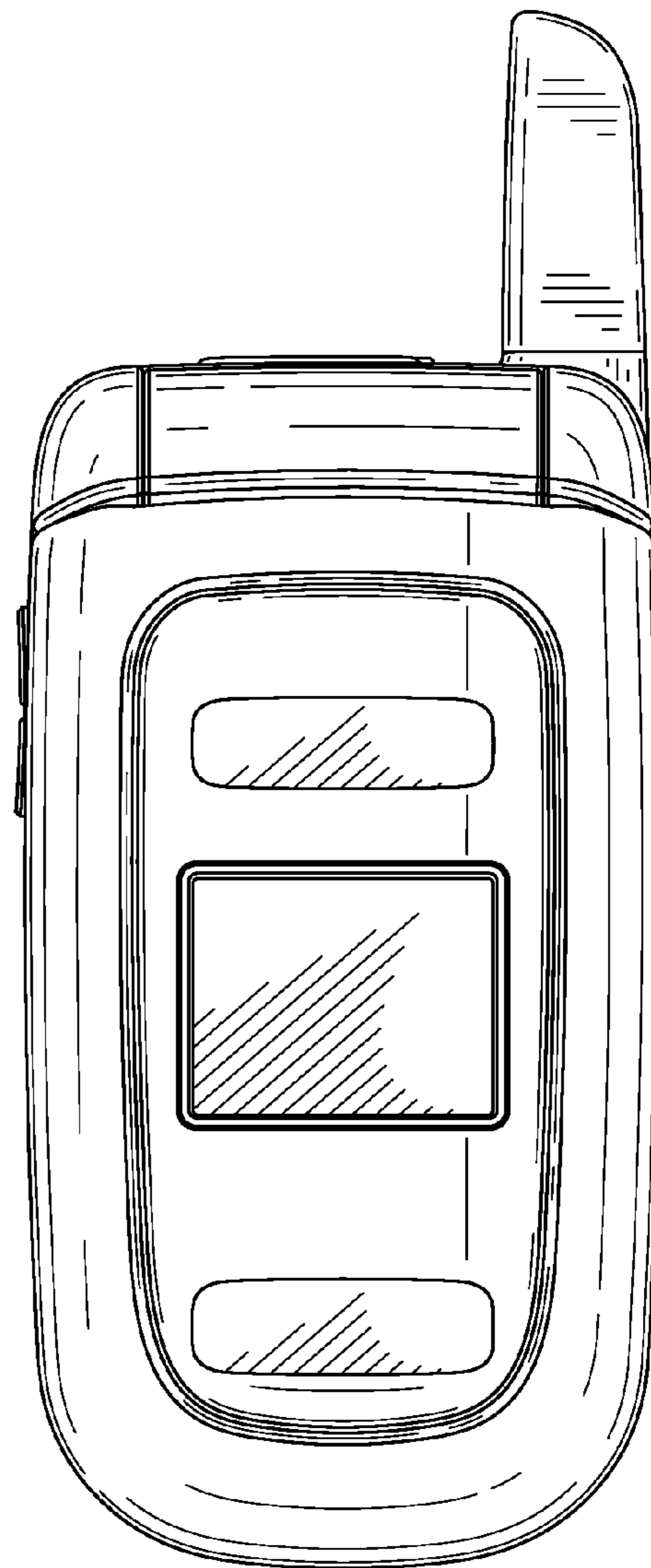

FIG. 13

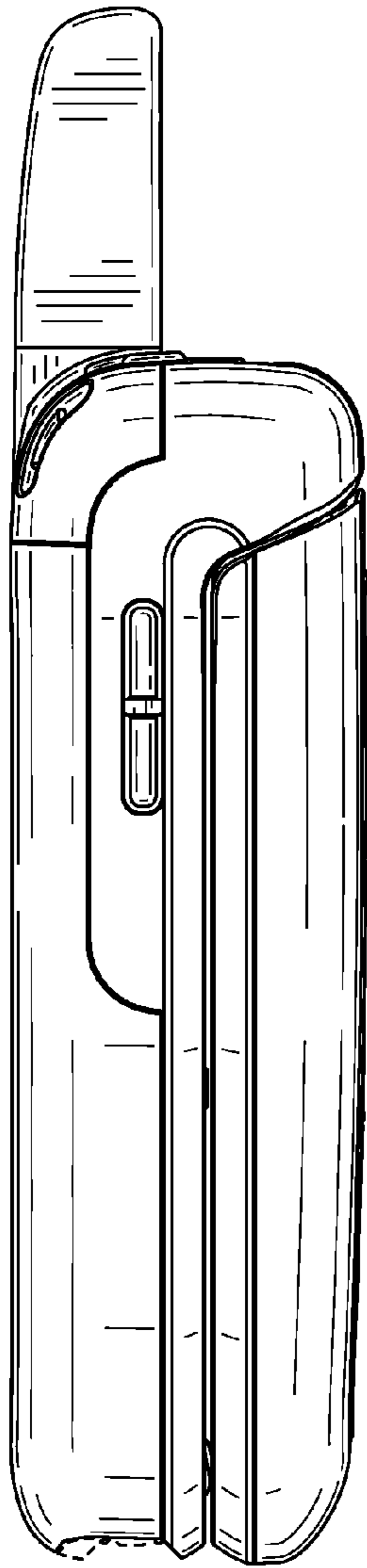

FIG. 14

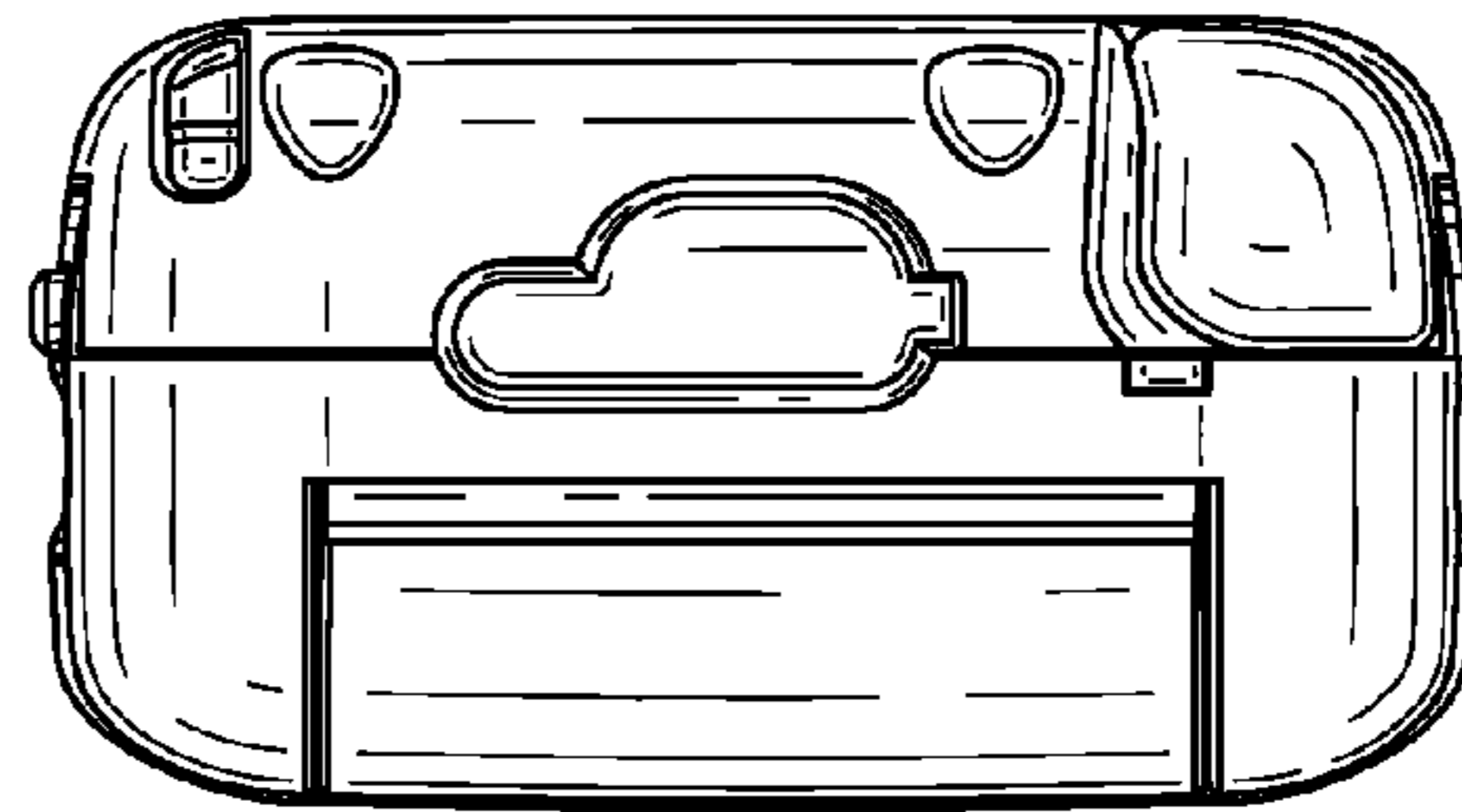

FIG. 15

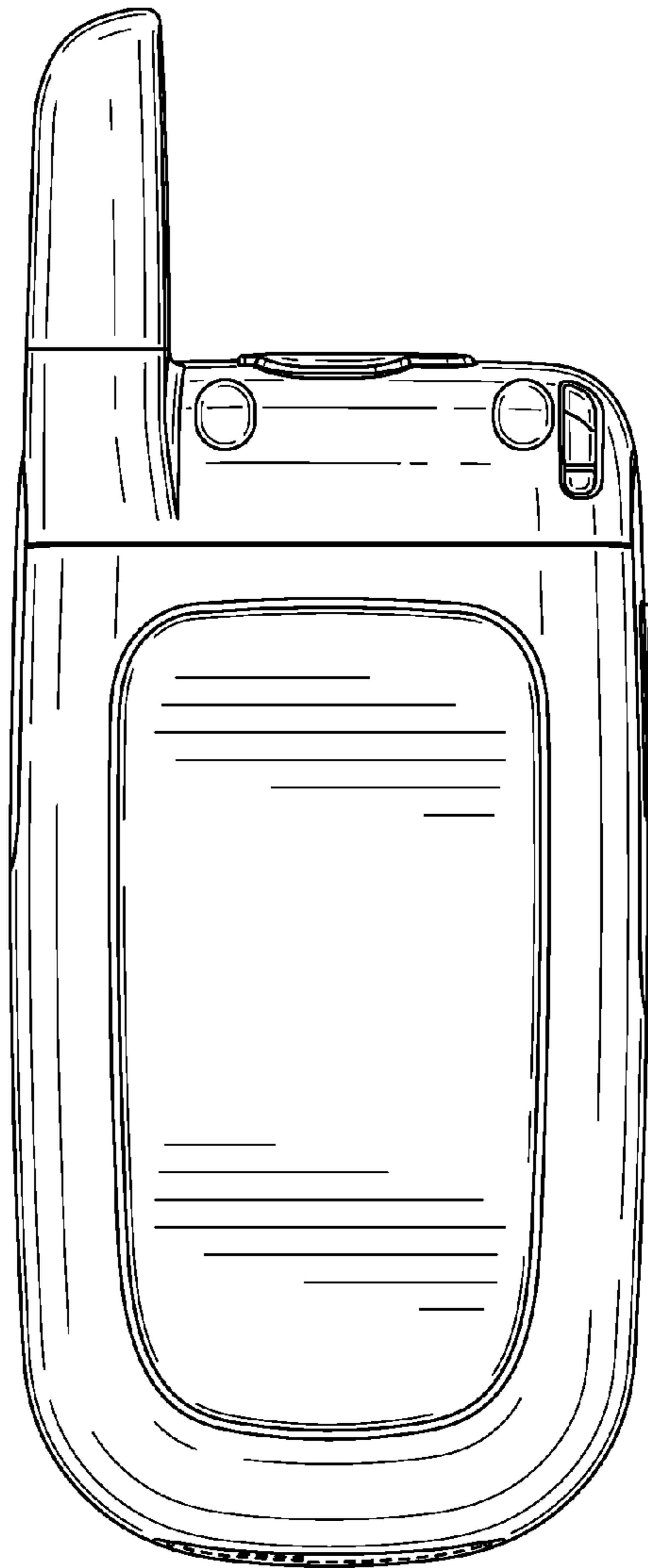

FIG. 16

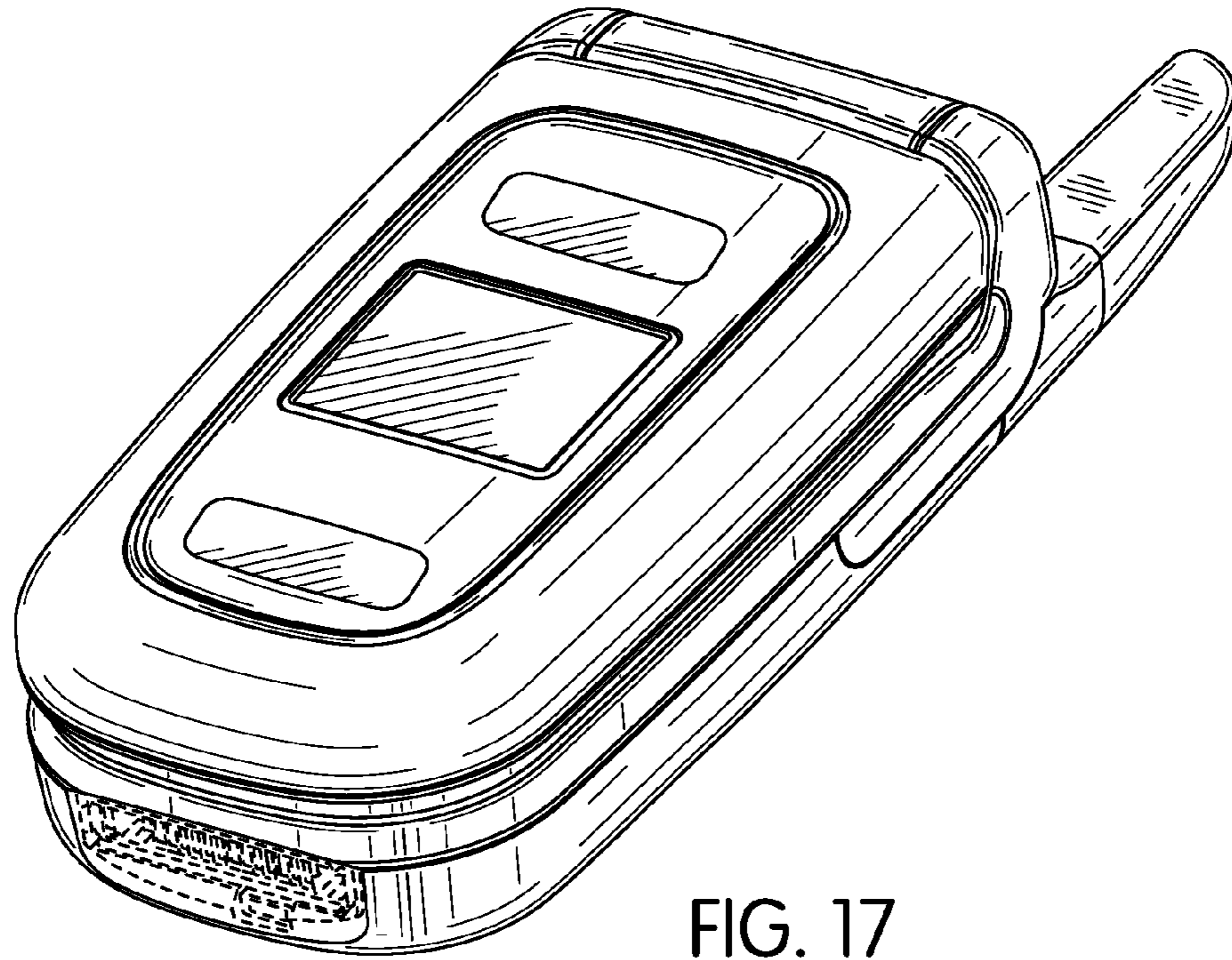

FIG. 17

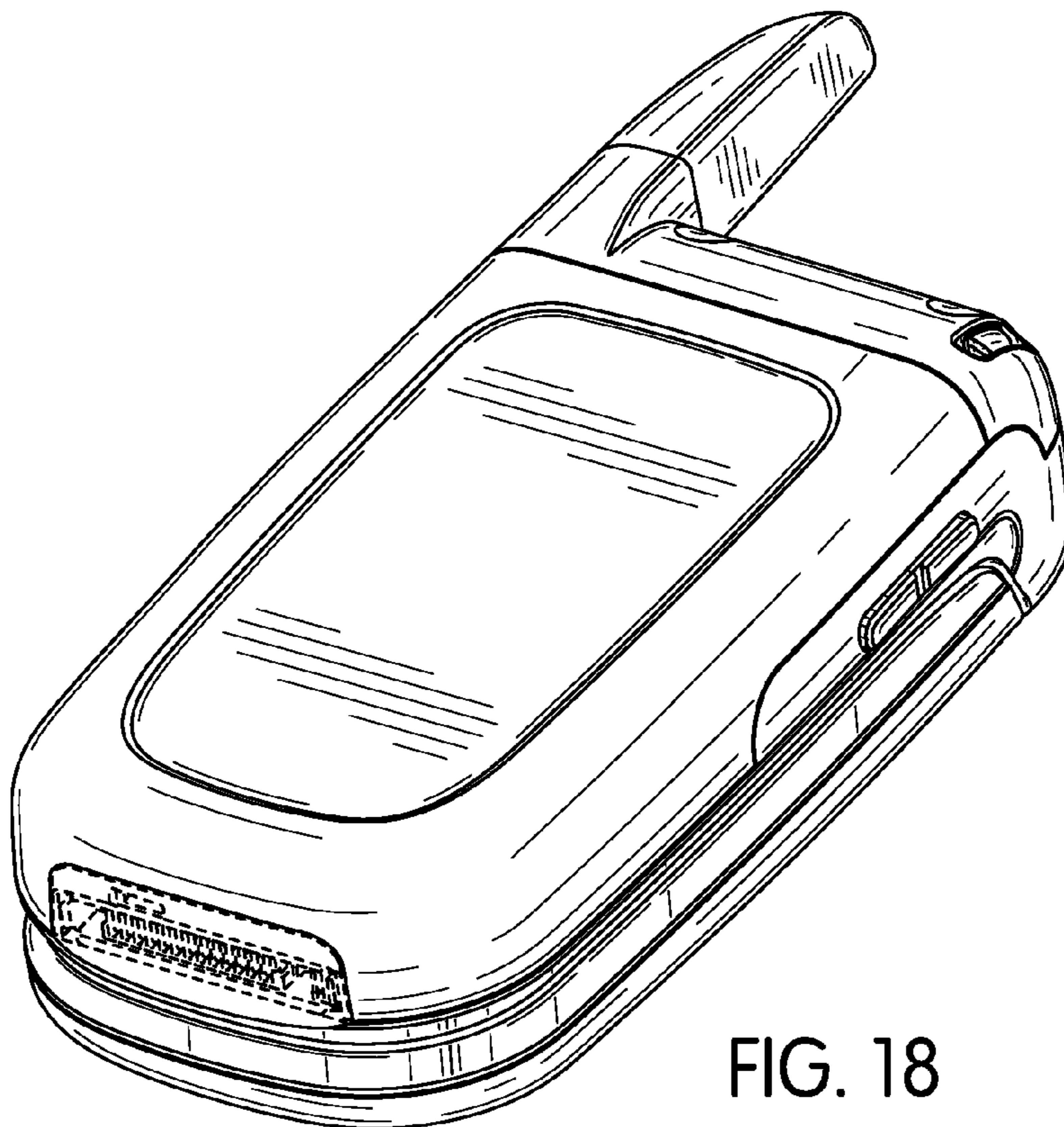

FIG. 18

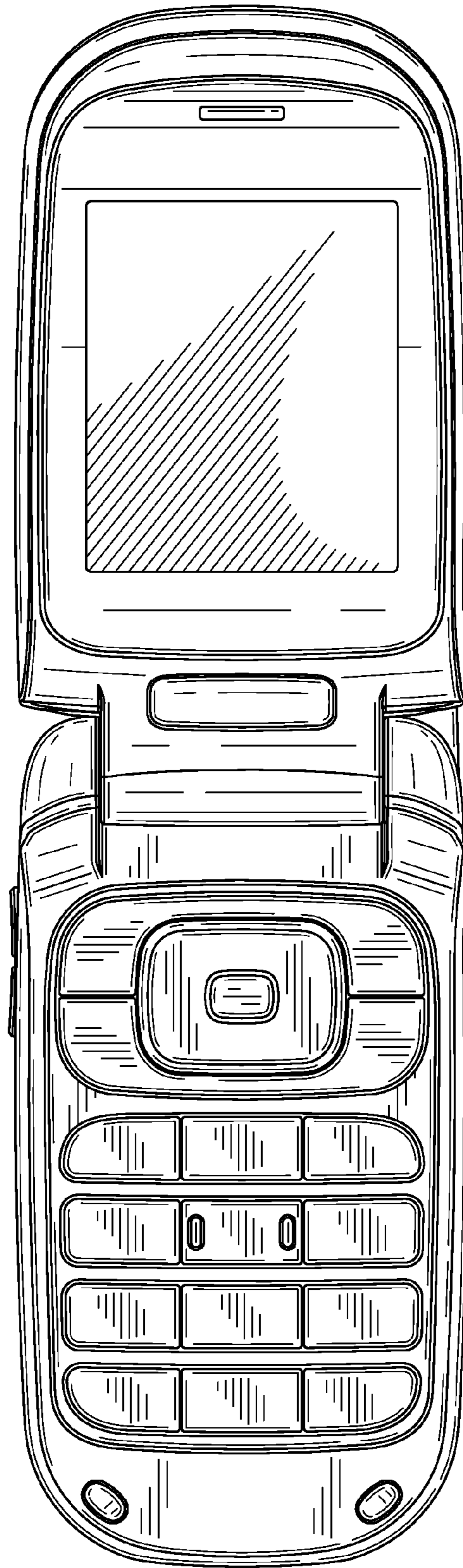
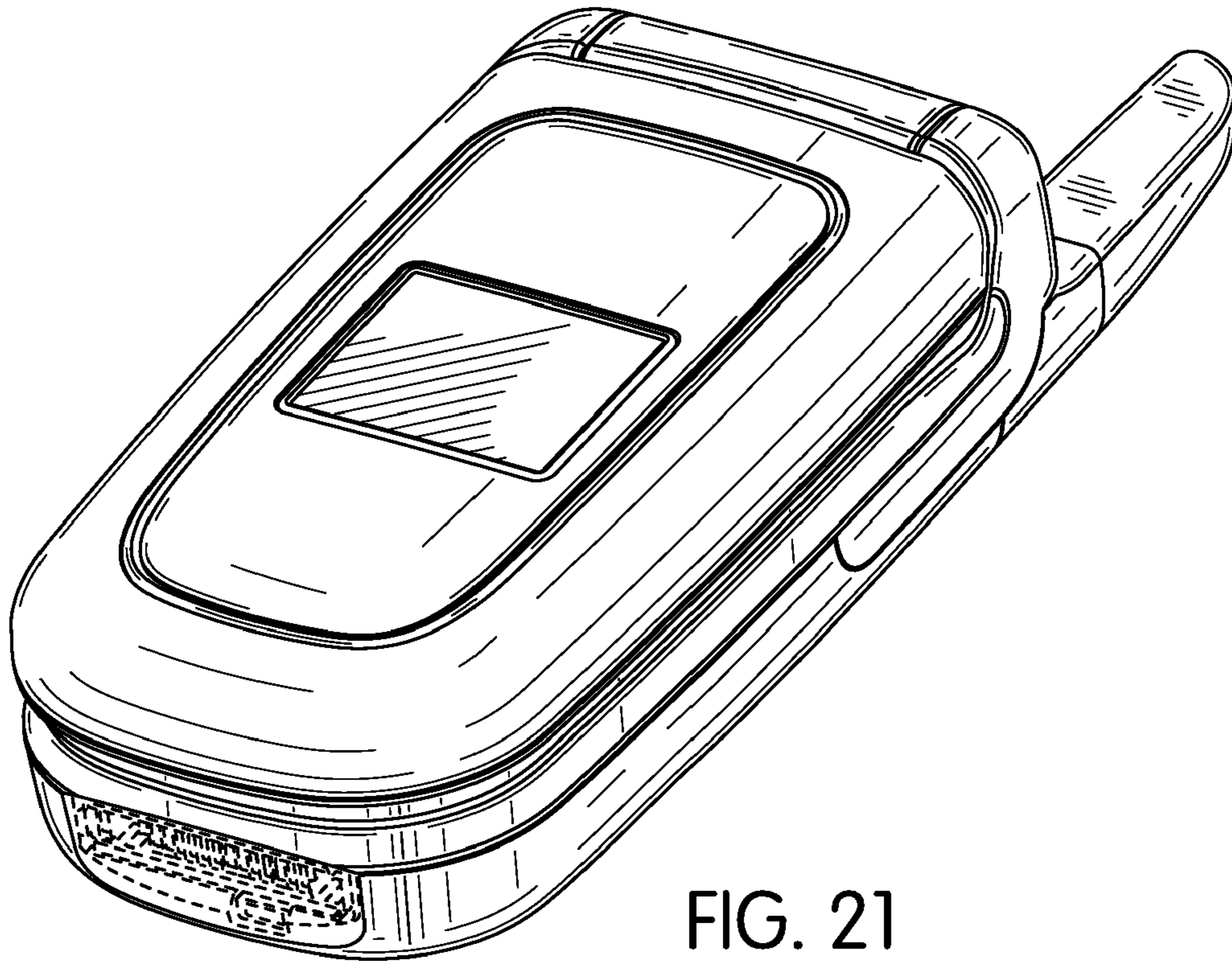

FIG. 19



FIG. 20



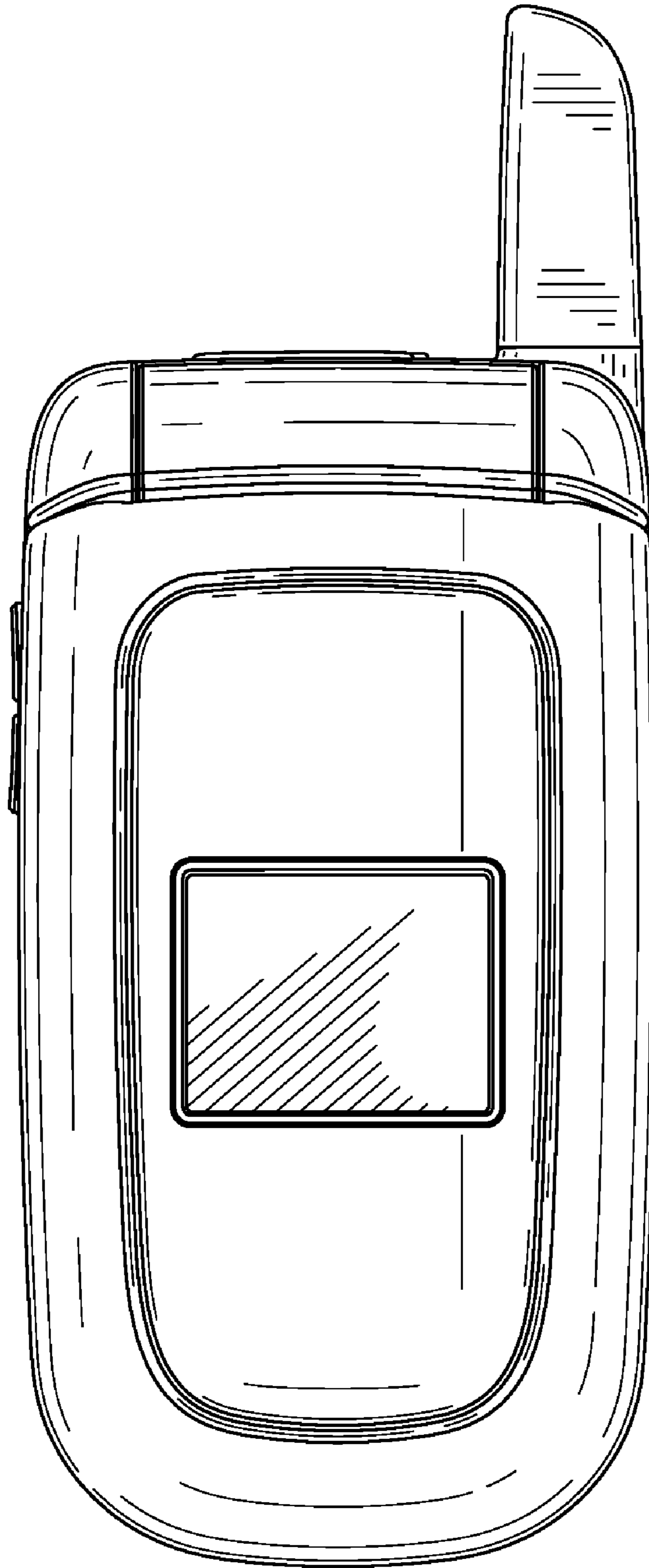

FIG. 22