



US00D577679S

(12) **United States Design Patent**  
**Lee**

(10) **Patent No.:** **US D577,679 S**  
(45) **Date of Patent:** **\*\* Sep. 30, 2008**

(54) **ELECTRICAL OUTLET**

(75) Inventor: **Dominic Kam Nam Lee**, Hong Kong  
(CN)

(73) Assignee: **Multway Industries Ltd**, Hong Kong  
(CN)

(\*\*) Term: **14 Years**

(21) Appl. No.: **29/236,017**

(22) Filed: **Aug. 10, 2005**

(51) **LOC (8) Cl.** ..... **13-03**

(52) **U.S. Cl.** ..... **D13/139.7**

(58) **Field of Classification Search** ..... D13/137.1,  
D13/137.3, 137.4, 139.1, 139.4, 139.6–139.8,  
D13/160, 162, 164, 178, 184; 361/118, 119;  
439/106–108, 188, 535, 650–654

See application file for complete search history.

(56) **References Cited**

**U.S. PATENT DOCUMENTS**

D164,338 S *	8/1951	Tyler	.....	D13/137.2
D428,327 S *	7/2000	Stekelenburg	.....	D8/359
D434,000 S *	11/2000	Miller	.....	D13/137.4
D445,091 S *	7/2001	Tong et al.	.....	D13/139.8
D483,331 S *	12/2003	Adachi et al.	.....	D13/139.7
D483,723 S *	12/2003	Adachi et al.	.....	D13/139.7
D487,726 S *	3/2004	Okuda	.....	D13/156
D549,657 S *	8/2007	Ng	.....	D13/139.8

**OTHER PUBLICATIONS**

Consumer Products Catalogue, p. 2, www.exit.com.tw, Apr. 26, 2005.

\* cited by examiner

*Primary Examiner*—Jennifer Rivard  
*Assistant Examiner*—Rosemary K Tarcza

(74) *Attorney, Agent, or Firm*—Frost Brown Todd, LLC

(57) **CLAIM**

The ornamental design for an electrical outlet, as shown and described.

**DESCRIPTION**

FIG. 1 presents a front pictorial view of an electrical outlet embodying my ornamental design.

FIG. 2 presents a front elevational view of my ornamental design.

FIG. 3 presents a right side elevational view of my ornamental design.

FIG. 4 presents a rear elevational view of my ornamental design.

FIG. 5 presents a left side elevational view of my ornamental design.

FIG. 6 presents a top plan view of my ornamental design.

FIG. 7 presents a bottom view of my ornamental design; and,

FIG. 8 presents a cross-sectional view taken along line 8—8 shown in FIG. 2.

The horizontal broken lines which connect the ends of the existing full line disclosure define the bounds of the claimed design. All other broken lines are for illustrative purposes only. None of the broken lines form a part of the claimed design.

**1 Claim, 7 Drawing Sheets**

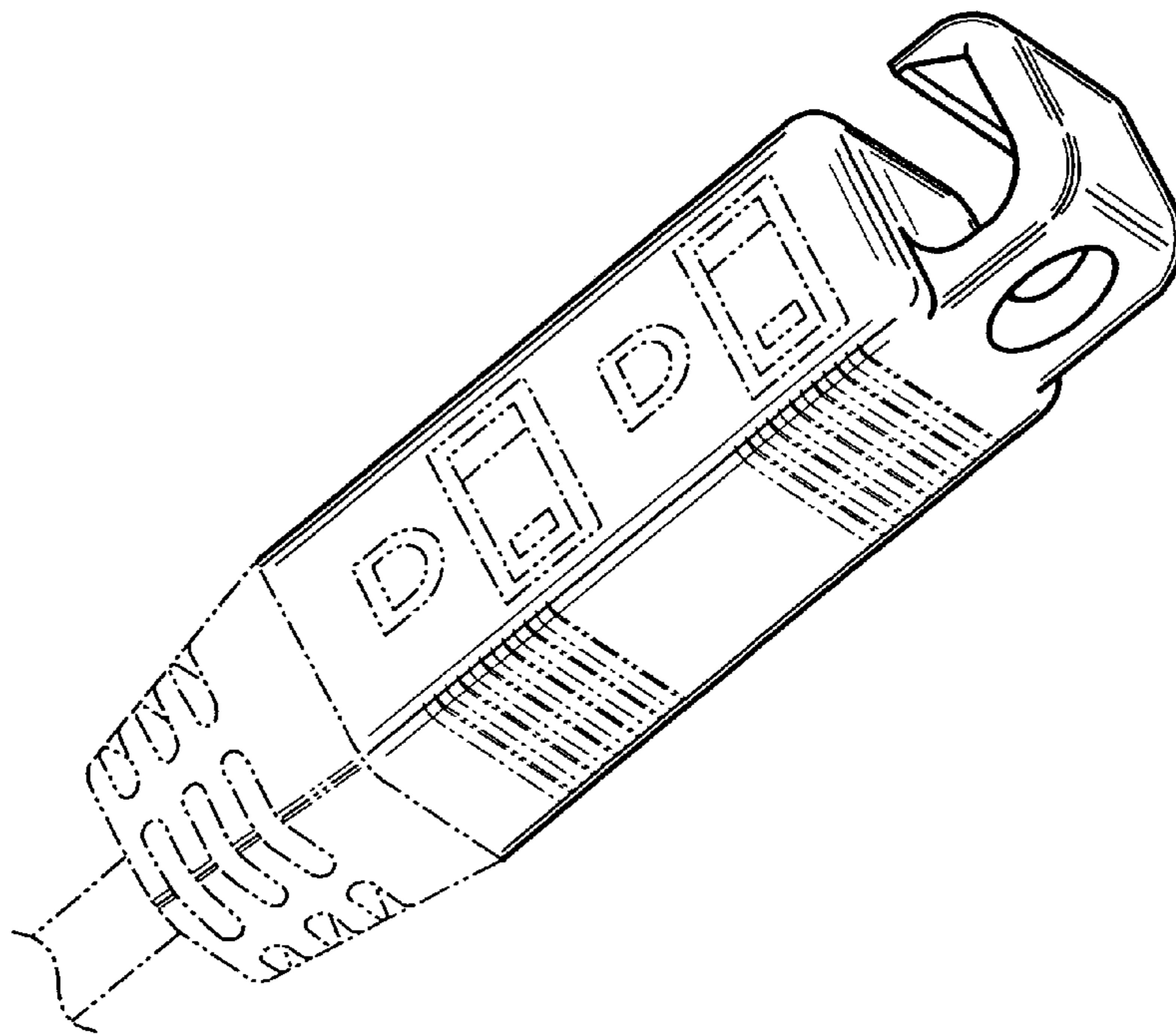

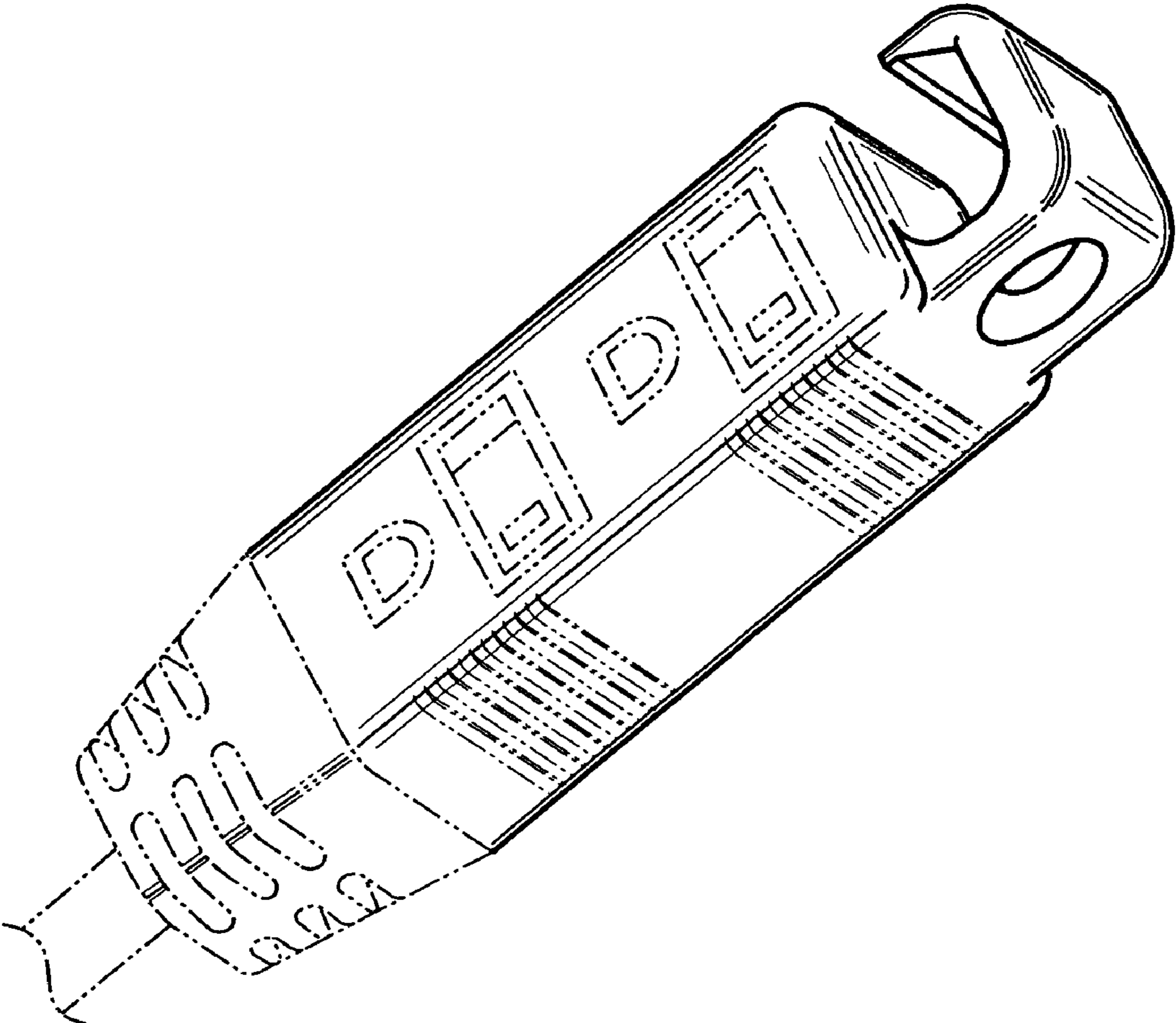

—FIG. 1

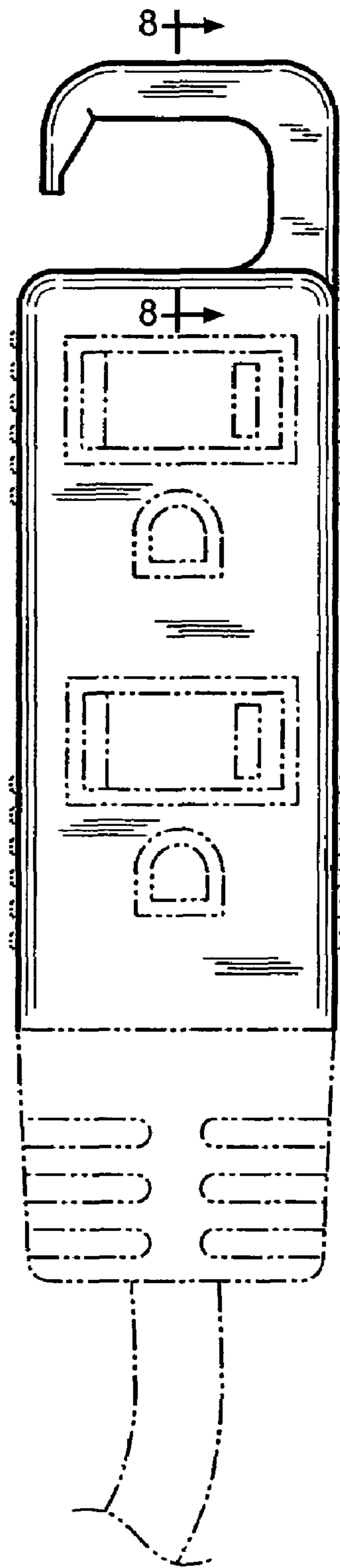
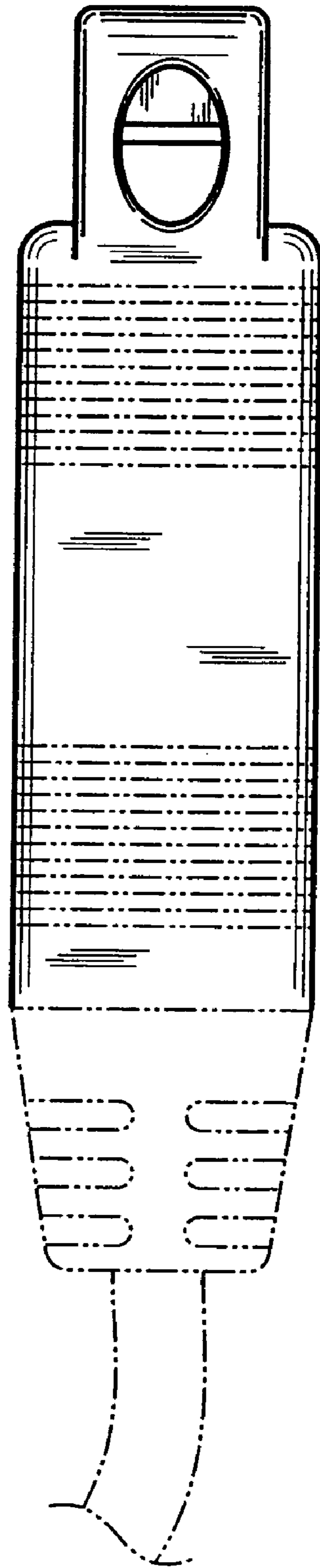
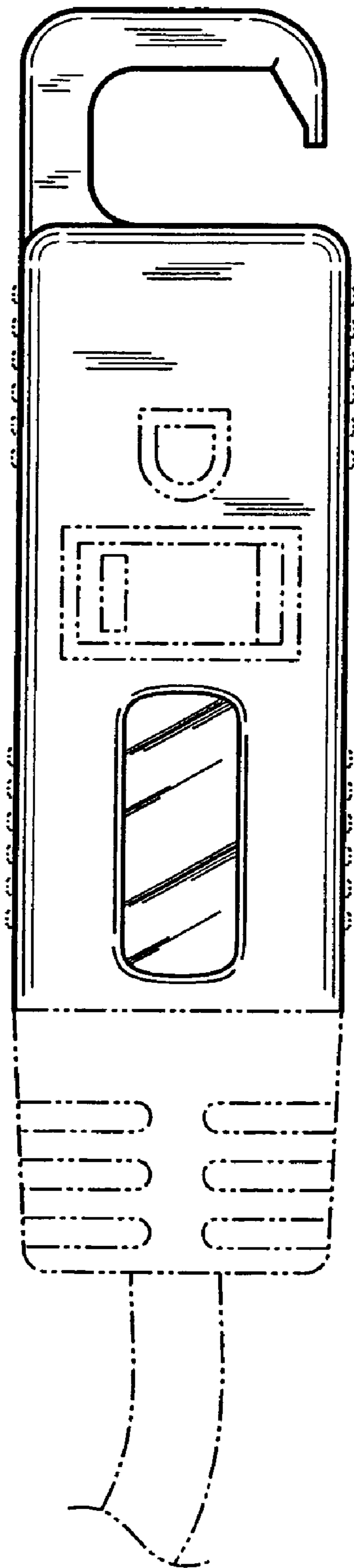

FIG. 2



—FIG. 3



—FIG. 4

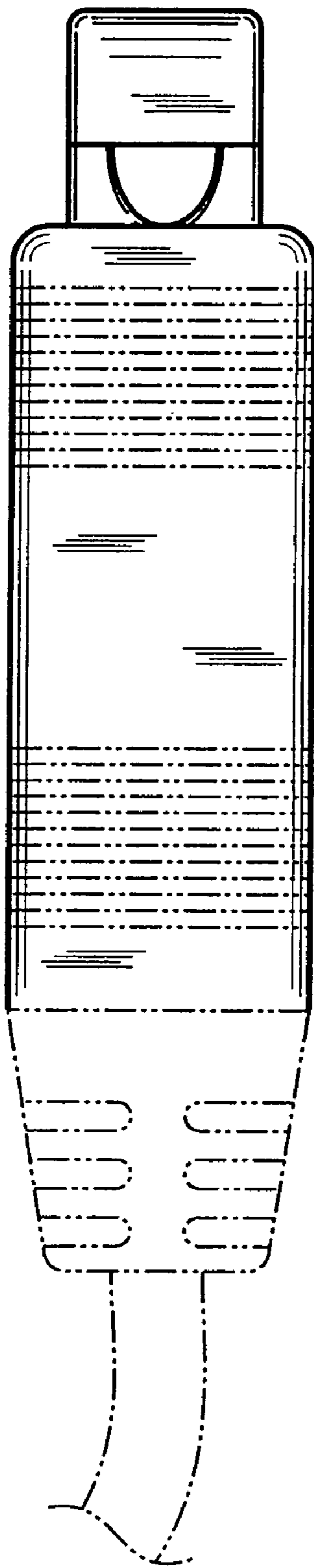

— FIG. 5

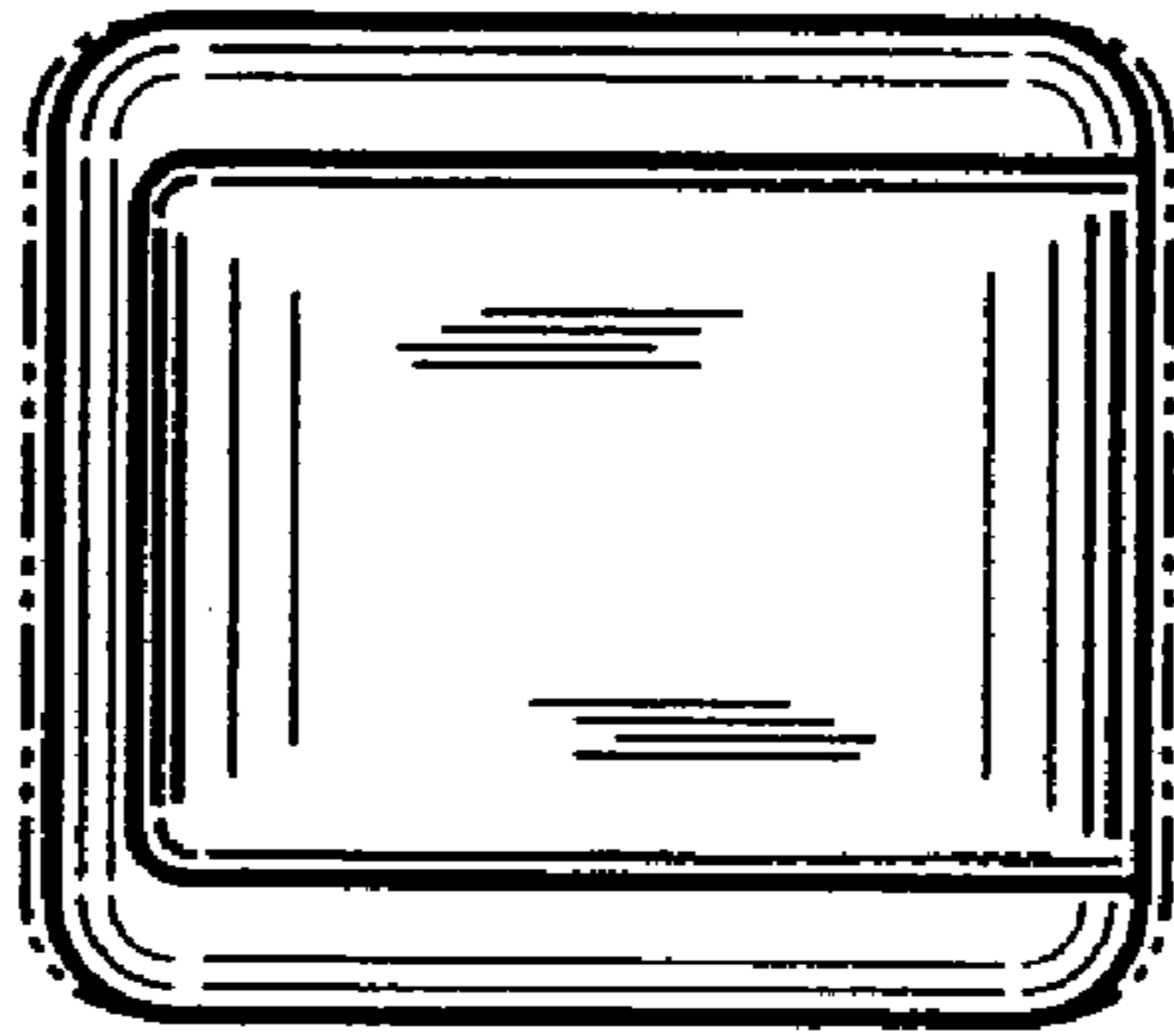

—FIG. 6

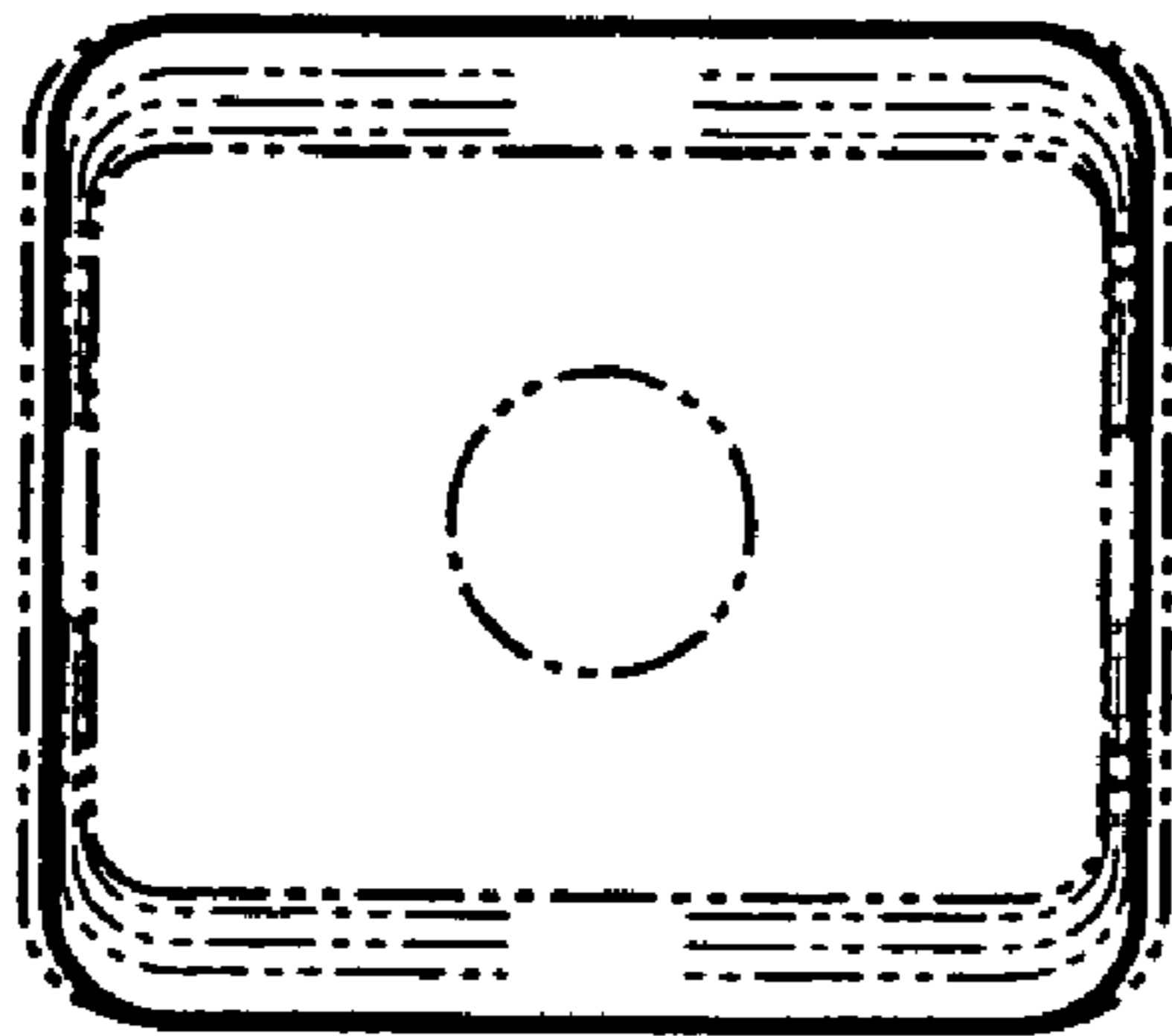

—FIG. 7



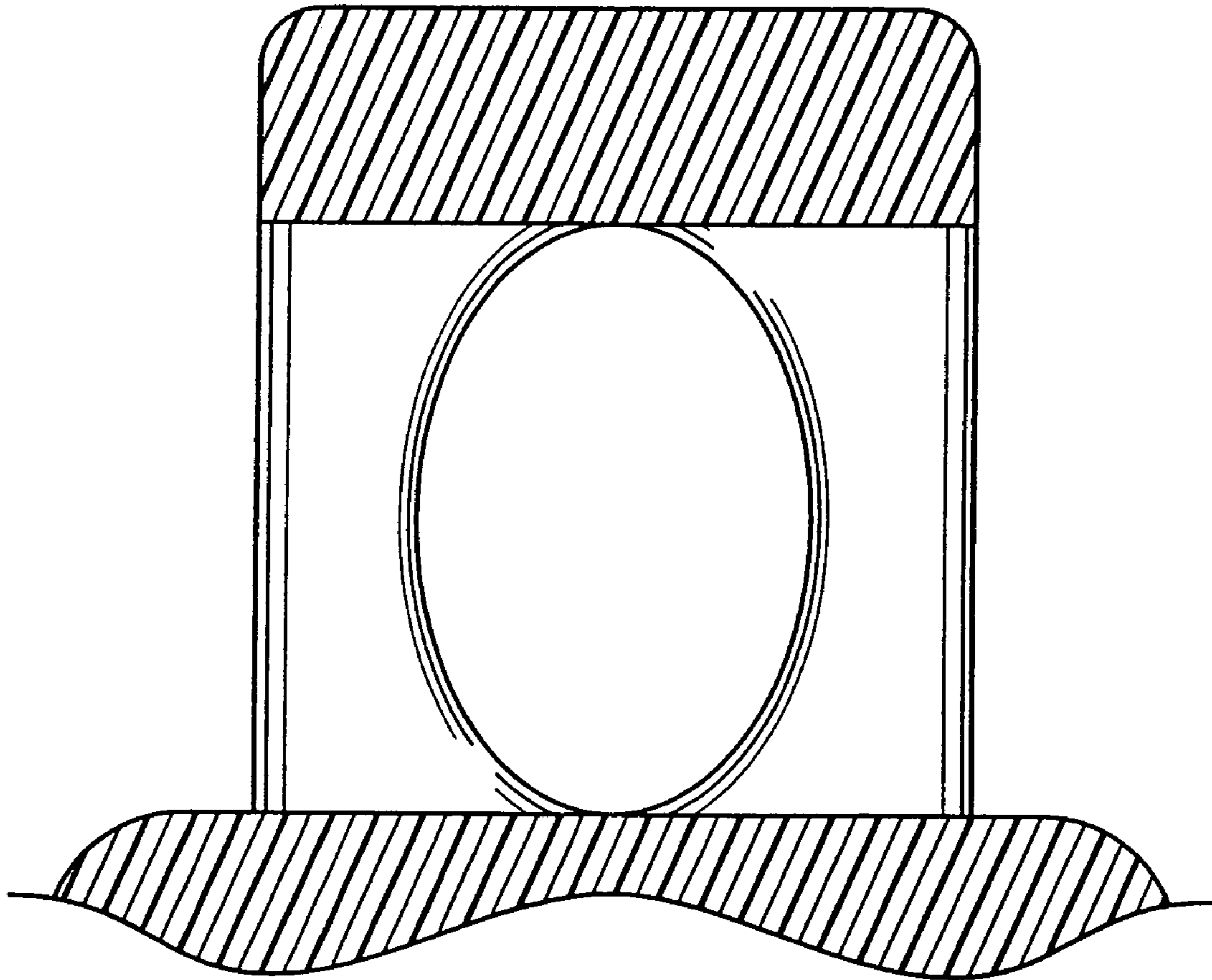

—FIG. 8