



US00D577563S

(12) **United States Design Patent**  
**Chen**

(10) **Patent No.:** **US D577,563 S**  
(45) **Date of Patent:** **\*\* Sep. 30, 2008**

(54) **HANDLE FOR PLIERS**

(76) Inventor: **Kun-Chen Chen**, No. 6, Lane 609, Sec. 1, Chung-Shan Rd., Ye-Her Li, Tachia Chen, Taichung Hsien (TW)

(\*\*) Term: **14 Years**

(21) Appl. No.: **29/289,851**

(22) Filed: **Aug. 3, 2007**

(51) **LOC (8) Cl.** ..... **08-05**

(52) **U.S. Cl.** ..... **D8/107**

(58) **Field of Classification Search** ..... D8/51,  
D8/52, 107, 303; 81/424, 424.5, 426, 427,  
81/427.5, 489

See application file for complete search history.

(56) **References Cited**

**U.S. PATENT DOCUMENTS**

D259,854 S *	7/1981	Wahlberg	.....	D8/58
D259,913 S *	7/1981	Wahlberg	.....	D8/58
D262,090 S *	12/1981	Wahlberg	.....	D8/58
D395,217 S *	6/1998	Start	.....	D8/52
D468,988 S *	1/2003	Goldmann et al.	.....	D8/107
6,513,198 B2 *	2/2003	Lu	.....	16/431
D486,047 S *	2/2004	Jansson et al.	.....	D8/52
D494,040 S *	8/2004	Phillips	.....	D8/107
D520,845 S *	5/2006	Wlaker	.....	D8/107
D521,348 S *	5/2006	Walker	.....	D8/107
D523,723 S *	6/2006	Walker	.....	D8/107

D528,380 S *	9/2006	Sue	.....	D7/693
D544,770 S *	6/2007	Yang	.....	D8/52
2002/0194706 A1 *	12/2002	Lu	.....	16/430

\* cited by examiner

*Primary Examiner*—Cathron Brooks

*Assistant Examiner*—Barbara Fox

(74) *Attorney, Agent, or Firm*—Jackson Walker, LLP

(57) **CLAIM**

The ornamental design for a handle for pliers, as shown and described.

**DESCRIPTION**

FIG. 1 is a perspective view of a handle for pliers, showing my new design;

FIG. 2 is a front view thereof;

FIG. 3 is a rear view thereof;

FIG. 4 is a left view thereof;

FIG. 5 is a right view thereof;

FIG. 6 is a top view thereof;

FIG. 7 is a bottom view thereof; and,

FIG. 8 is a top view of the handle for pliers showing different pliers.

Wherein, the broken lines are shown for illustrative purposes only and form no part of the claimed design.

**1 Claim, 5 Drawing Sheets**

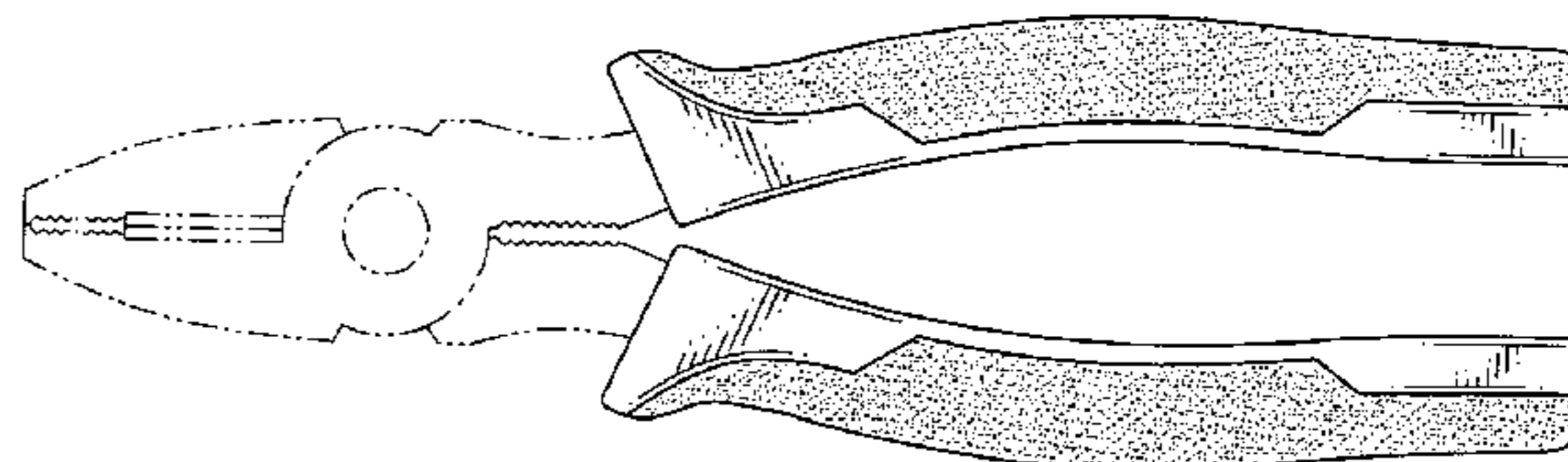
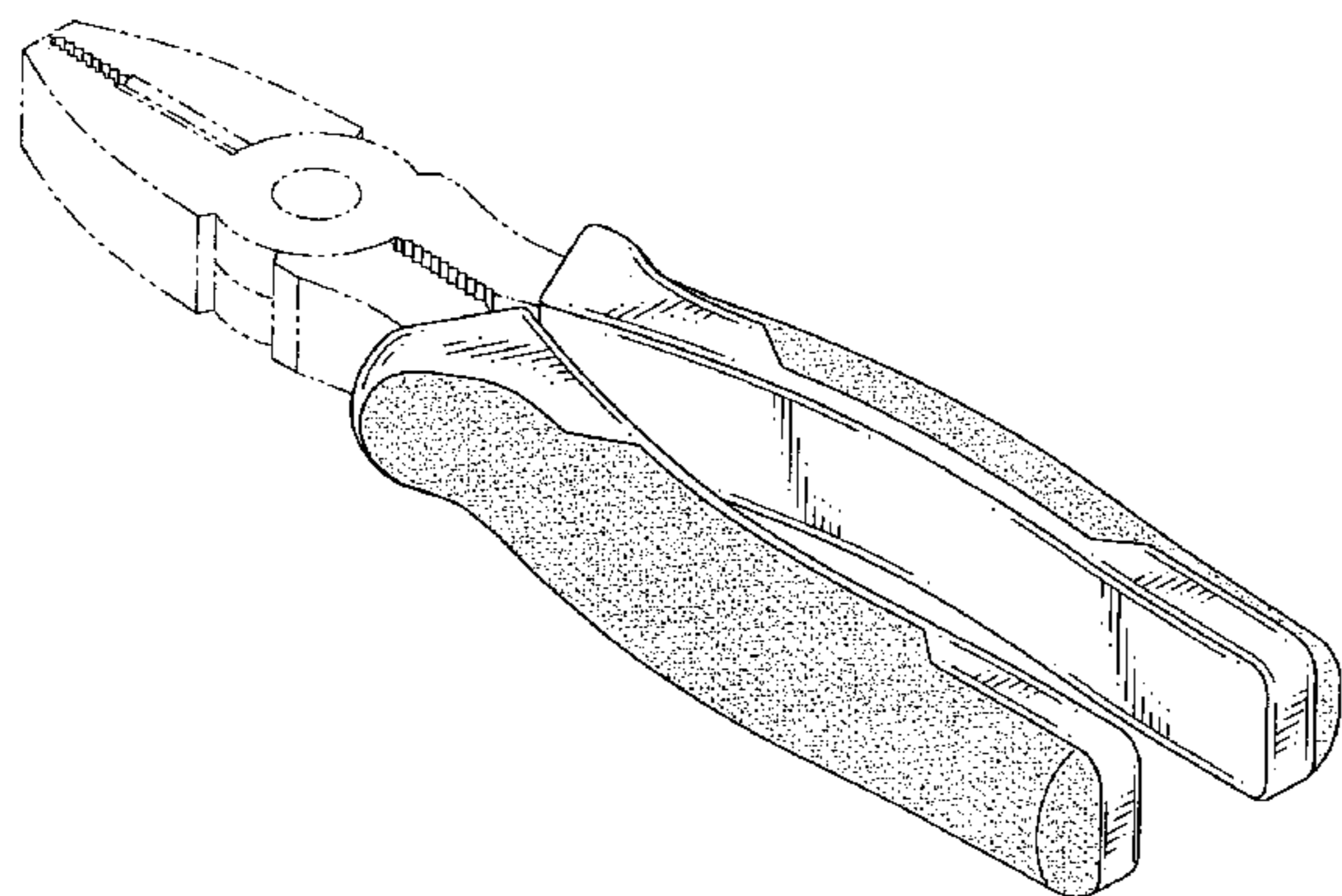

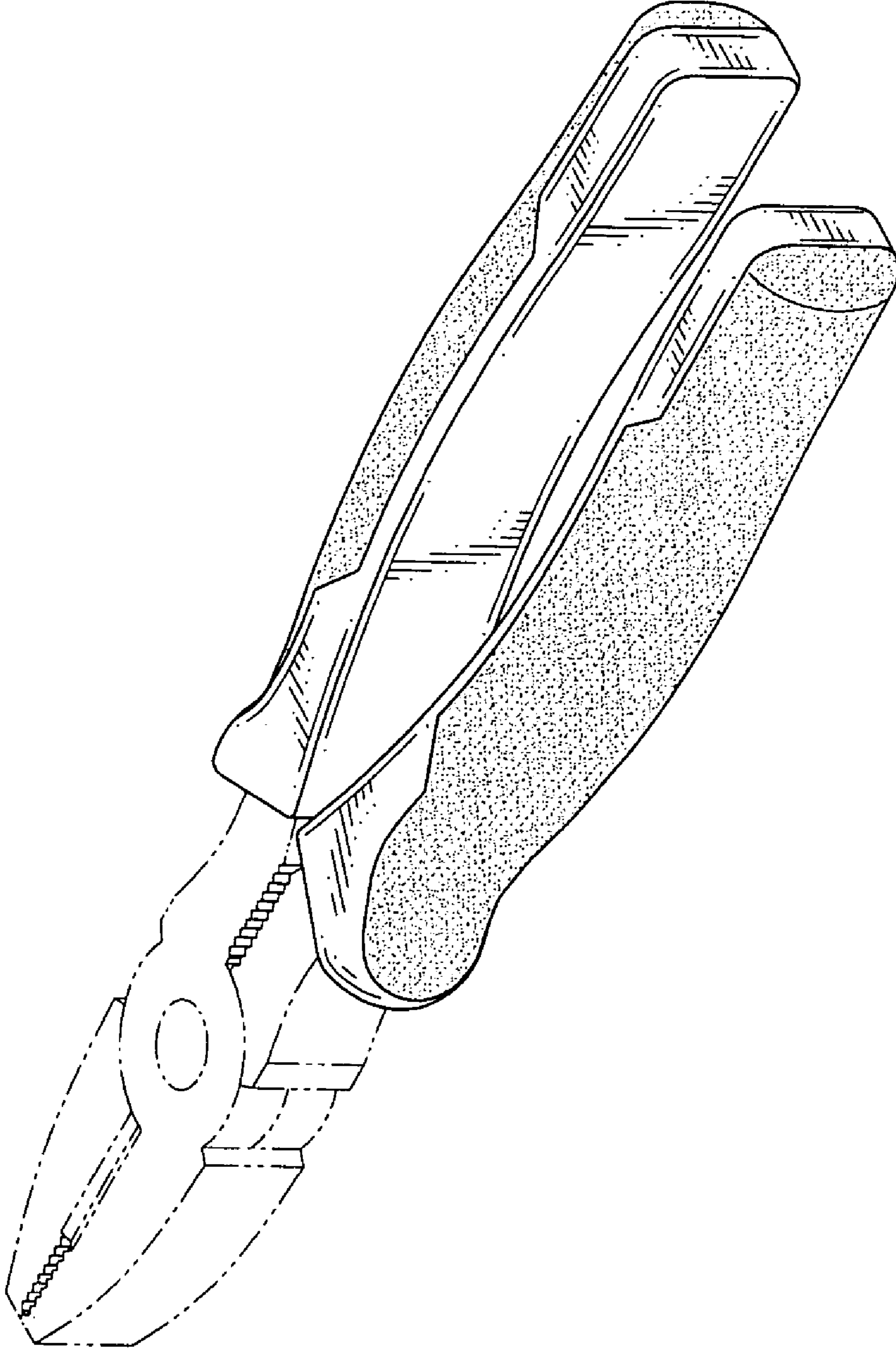

FIG. 1

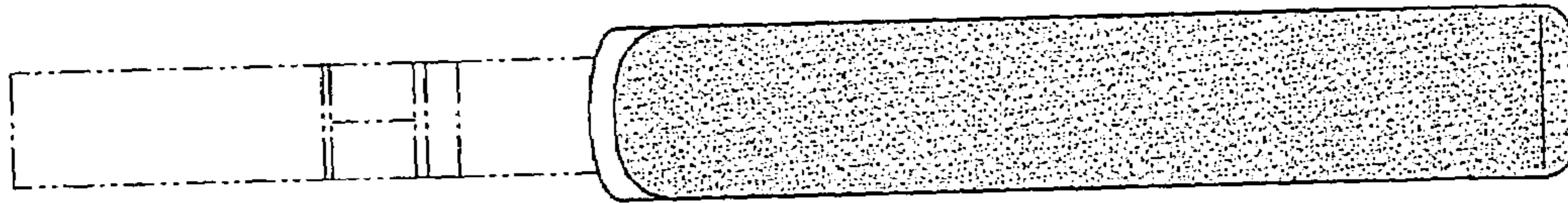

FIG. 2

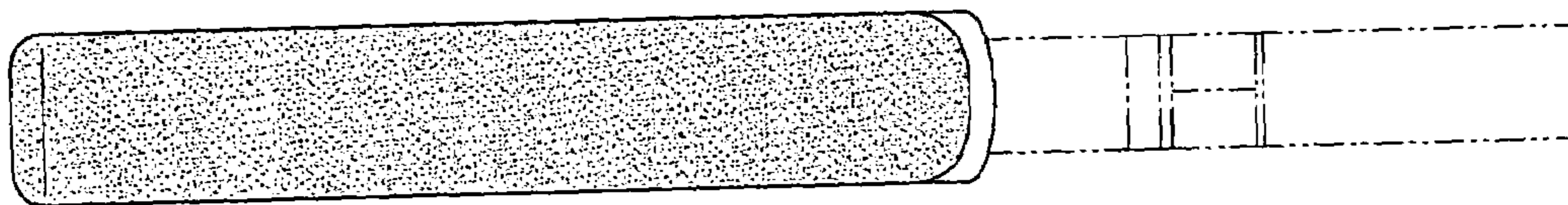

FIG. 3

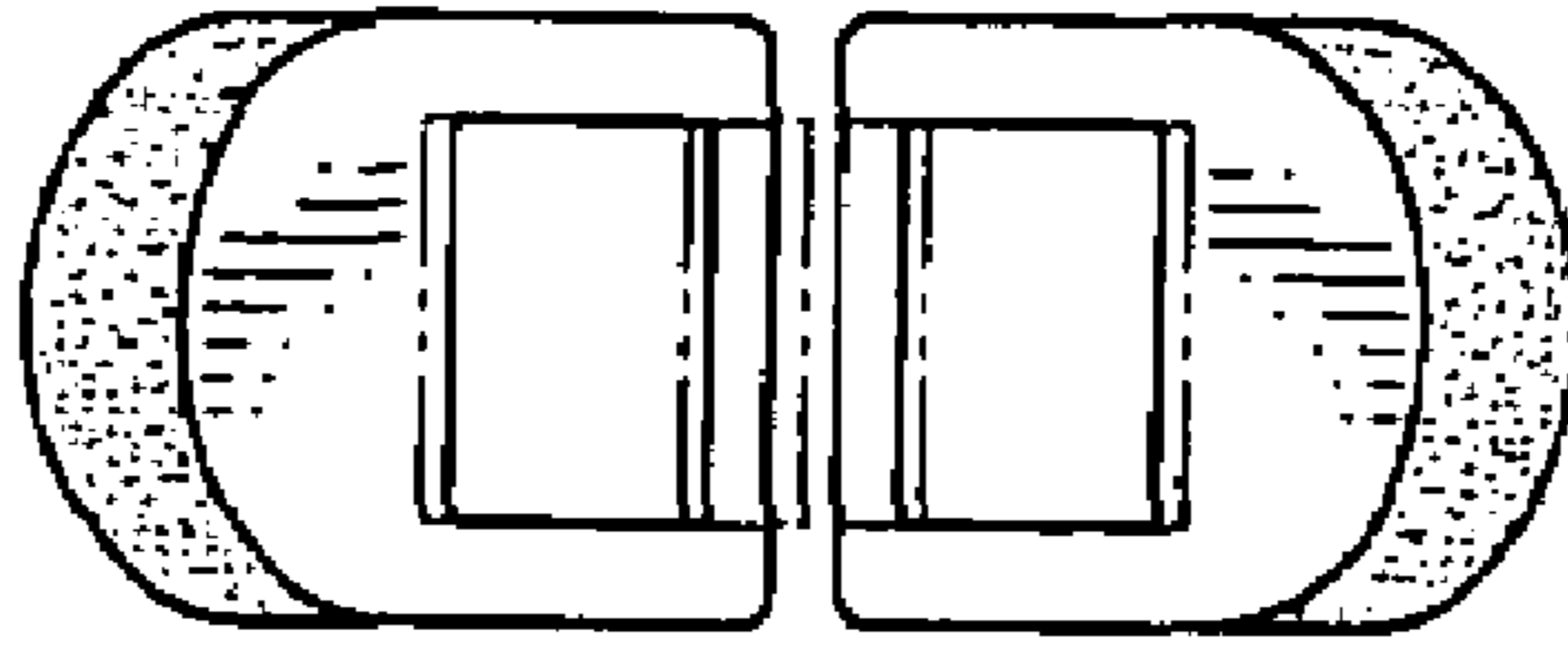

FIG. 4

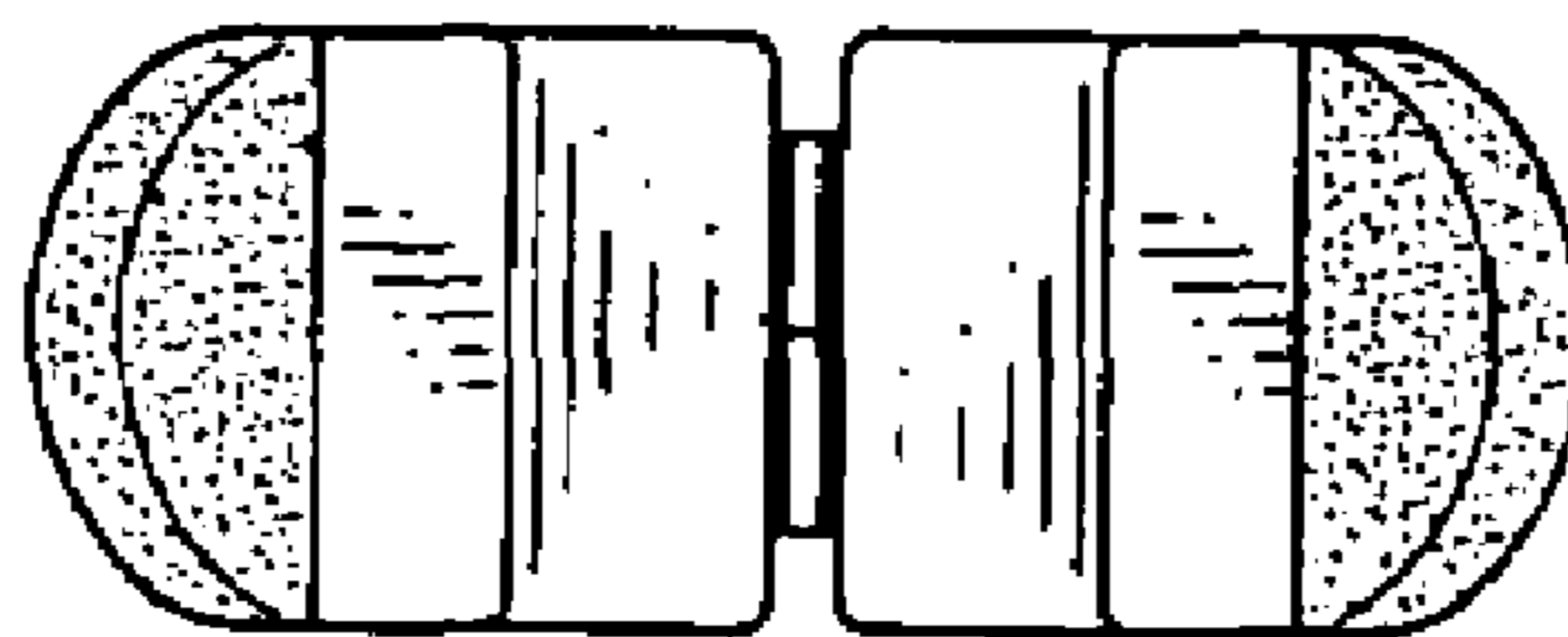

FIG. 5



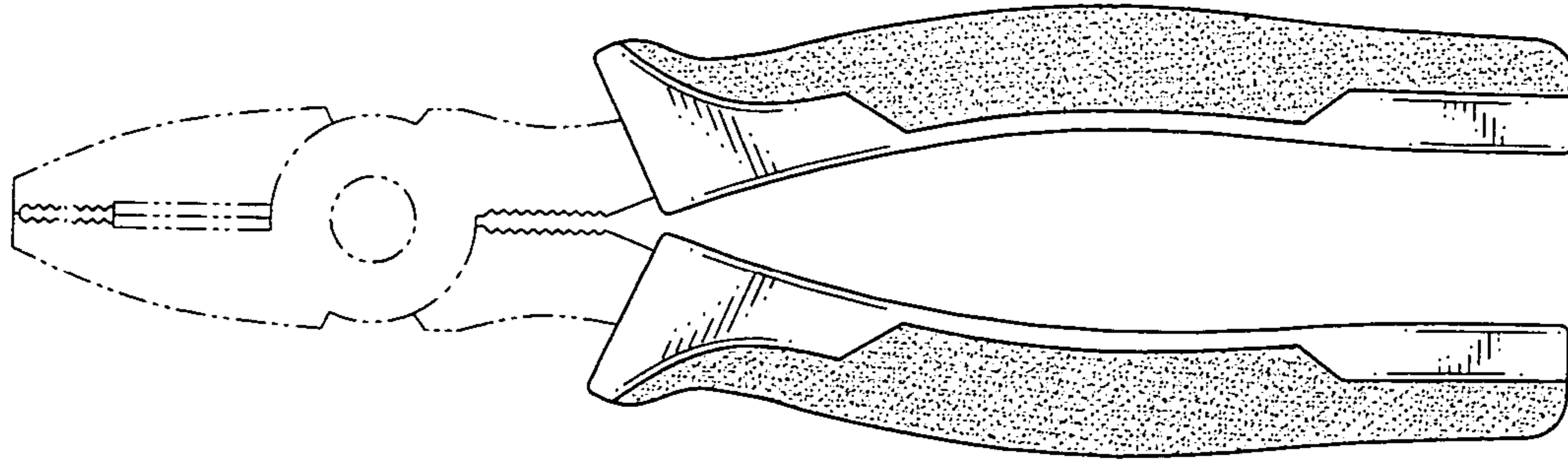

FIG. 6

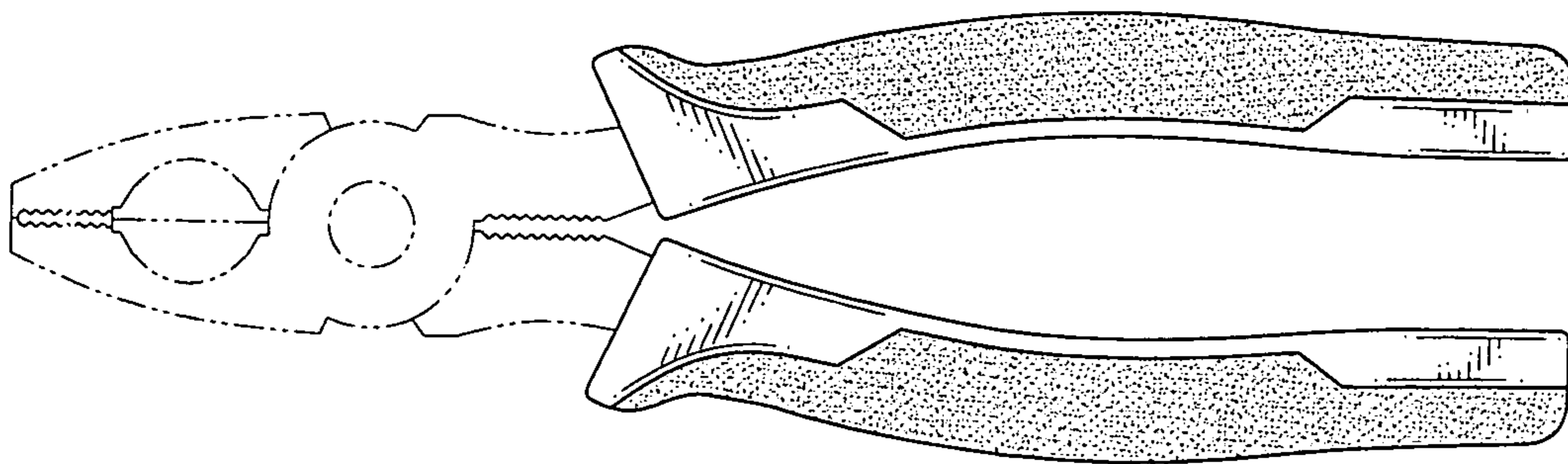

FIG. 7

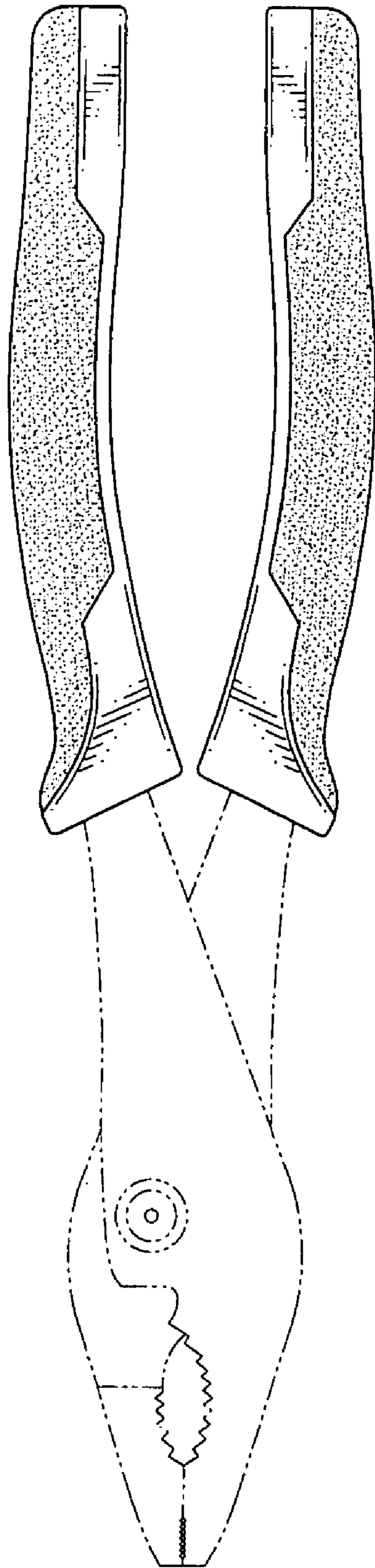

FIG. 8