



US00D577559S

(12) **United States Design Patent**
Ino

(10) **Patent No.:** **US D577,559 S**

(45) **Date of Patent:** **** Sep. 30, 2008**

(54) **ELECTRIC HAMMER DRILL**

(75) Inventor: **Tomoaki Ino**, Yokohama (JP)

(73) Assignee: **Matsushita Electric Works, Ltd.**,
Osaka (JP)

(**) Term: **14 Years**

(21) Appl. No.: **29/288,202**

(22) Filed: **Jun. 4, 2007**

(30) **Foreign Application Priority Data**

Dec. 4, 2006 (JP) 2006-033397

(51) **LOC (8) Cl.** **08-01**

(52) **U.S. Cl.** **D8/69**

(58) **Field of Classification Search** D8/14.1,
D8/61-70; 81/57.11, 429, 454-456, 469,
81/489; 173/13, 104, 114, 168-171, 178,
173/201, 211, 213, 217; 408/20, 124, 125,
408/234, 241 R; 451/358; 310/50; 227/8,
227/113, 114, 120, 130, 136, 142

See application file for complete search history.

(56) **References Cited**

U.S. PATENT DOCUMENTS

4,930,583	A *	6/1990	Fushiya et al.	173/170
D320,918	S *	10/1991	Mochida	D8/68
D442,452	S *	5/2001	Stirm et al.	D8/69
6,357,533	B1 *	3/2002	Buchholz et al.	173/217
6,412,572	B2 *	7/2002	Habedank et al.	173/217
D491,438	S *	6/2004	Cheung et al.	D8/68
6,971,456	B2 *	12/2005	Yamada et al.	173/168
D535,537	S *	1/2007	Aglassinger	D8/69
D543,082	S *	5/2007	Stirm	D8/69
2001/0040036	A1 *	11/2001	Habedank et al.	173/217
2005/0034883	A1 *	2/2005	Yamada et al.	173/217
2006/0144604	A1 *	7/2006	Soika et al.	173/211
2007/0044983	A1 *	3/2007	Wuensch et al.	173/217

FOREIGN PATENT DOCUMENTS

GB	2085824	S *	8/1999
GB	3015689	S *	12/2003
JP	1171219		4/2003

* cited by examiner

Primary Examiner—T. Chase Nelson
(74) *Attorney, Agent, or Firm*—Osha Liang LLP

(57) **CLAIM**

The ornamental design for an electric hammer drill, as shown and described.

DESCRIPTION

FIG. 1 is a reference back, left, and top perspective view of the design according to the invention wherein a broken line rod has been installed.

FIG. 2 is a reference front, right, and top perspective view of the design according to the invention wherein a broken line rod has been installed, and the handle at the front end of the design is shown in an alternate position from that of the remaining views.

FIG. 3 is a right side view of the design according to the invention.

FIG. 4 is a left side view of the design according to the invention.

FIG. 5 is a front view of the design according to the invention.

FIG. 6 is a back view of the design according to the invention.

FIG. 7 is a top plan view of the design according to the invention.

FIG. 8 is a bottom plan view of the design according to the invention.

FIG. 9 is a reference front, right, and top perspective view of the design according to the invention wherein the battery pack has been removed, and a broken line rod has been installed; and,

FIG. 10 is a reference back, right, and top perspective view of the design according to the invention wherein the battery pack has been removed, and a broken line rod has been installed.

The broken line showing of a rod in the FIGS. 1, 2, 9, and 10 views is for purposes of illustrating unclaimed environmental structure. In the other views in which it would be seen, the broken line rod has been removed. The broken lines form no part of the claimed design.

1 Claim, 10 Drawing Sheets

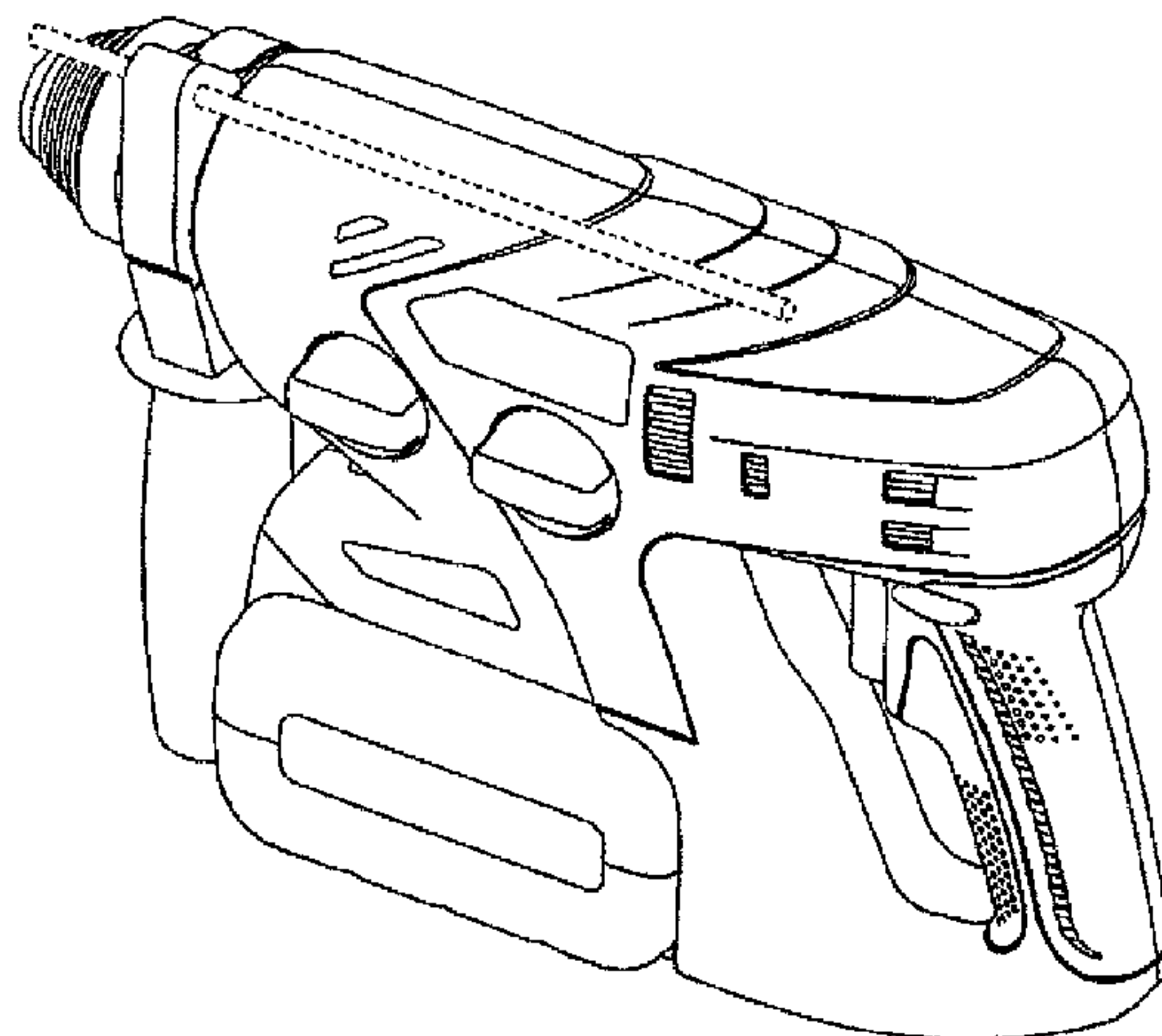

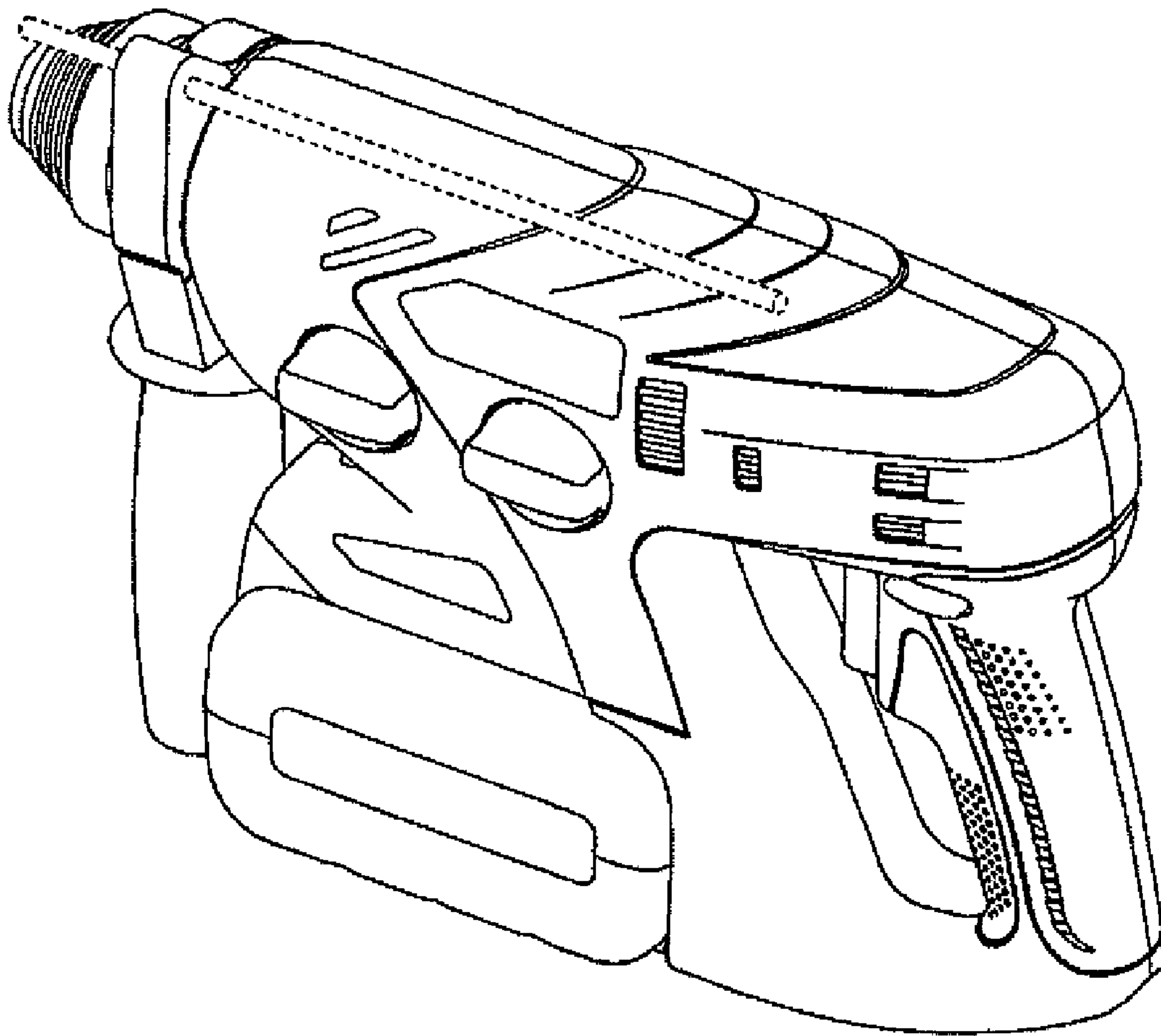

Fig. 1

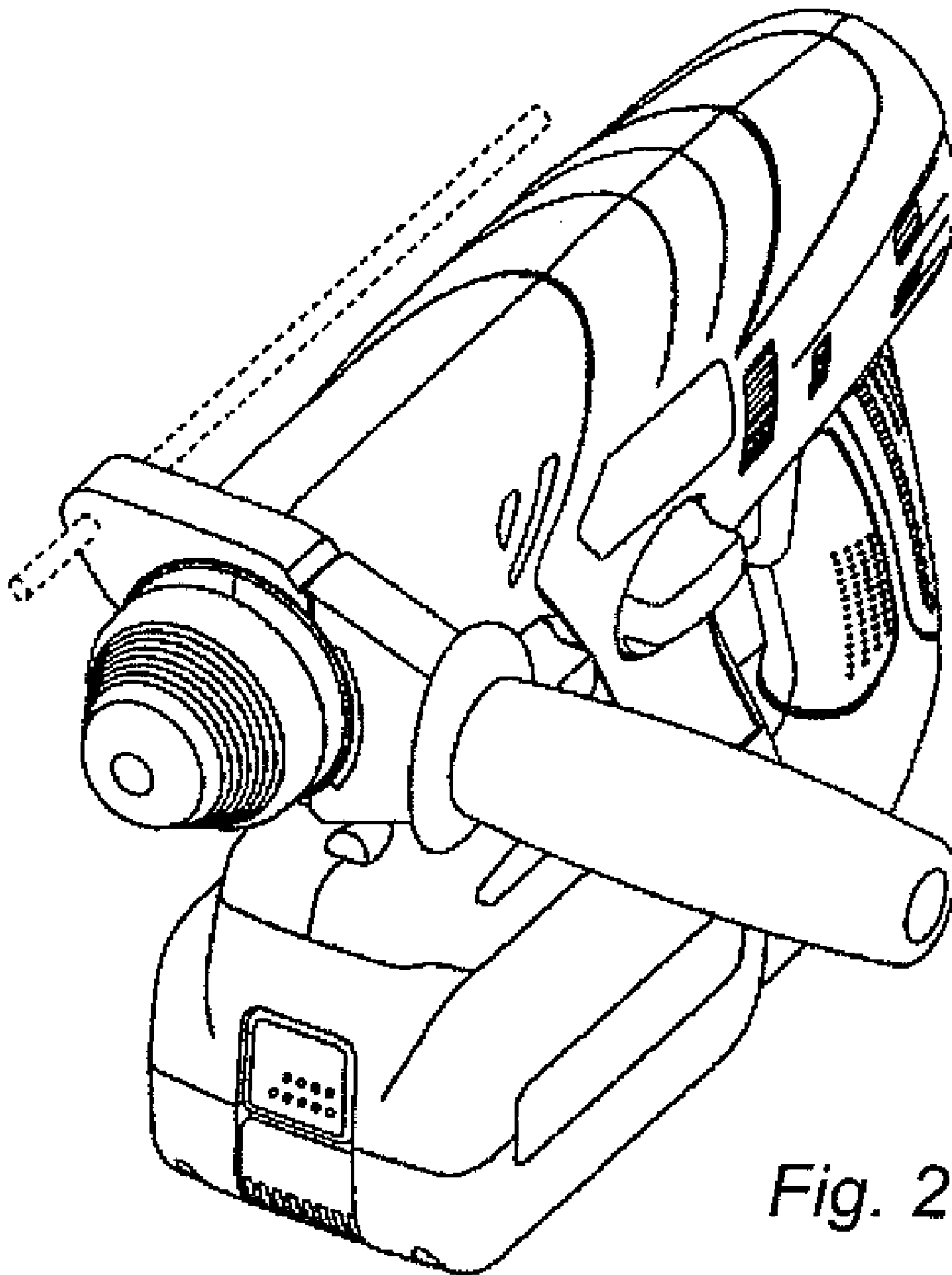

Fig. 2

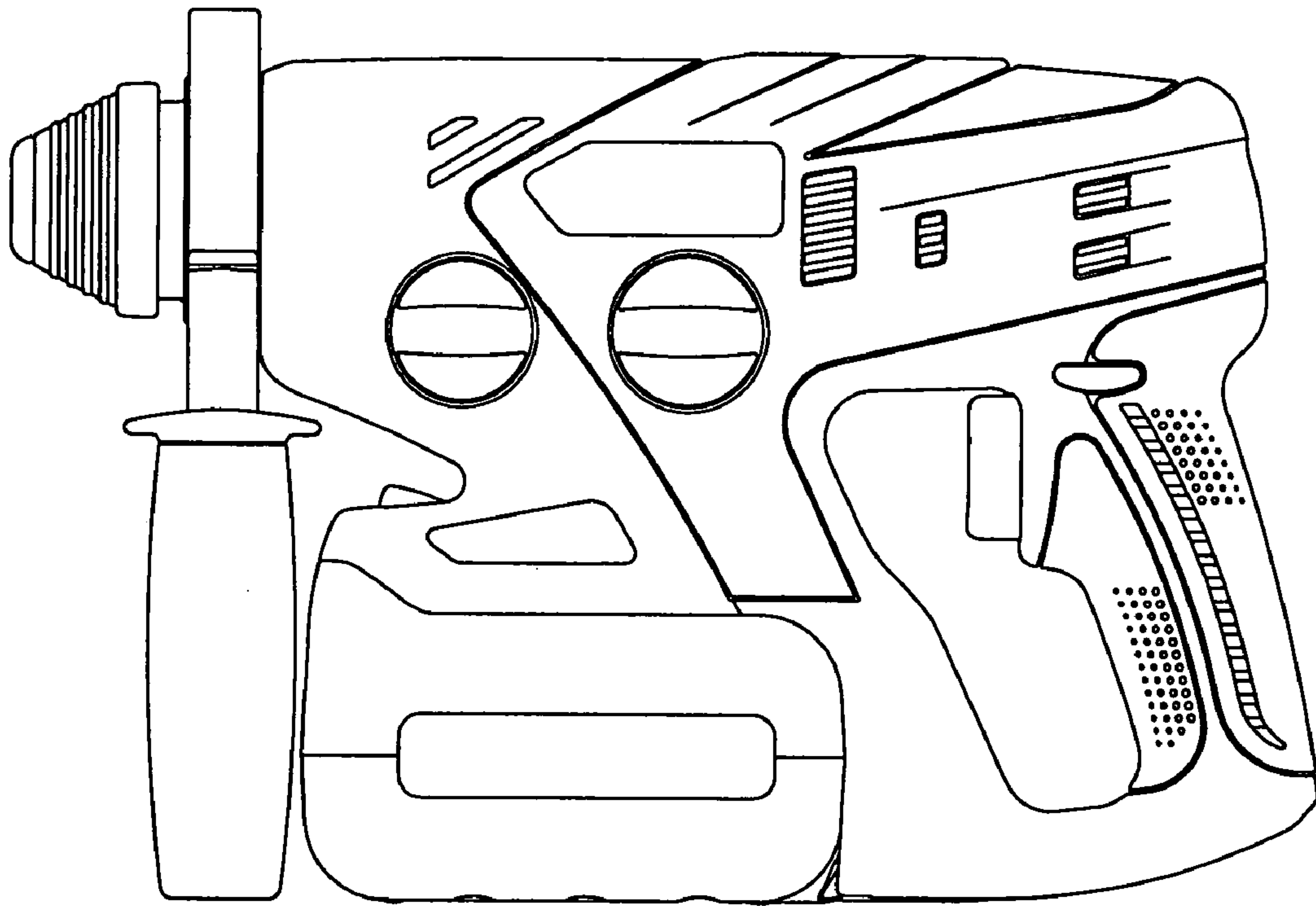

Fig. 3

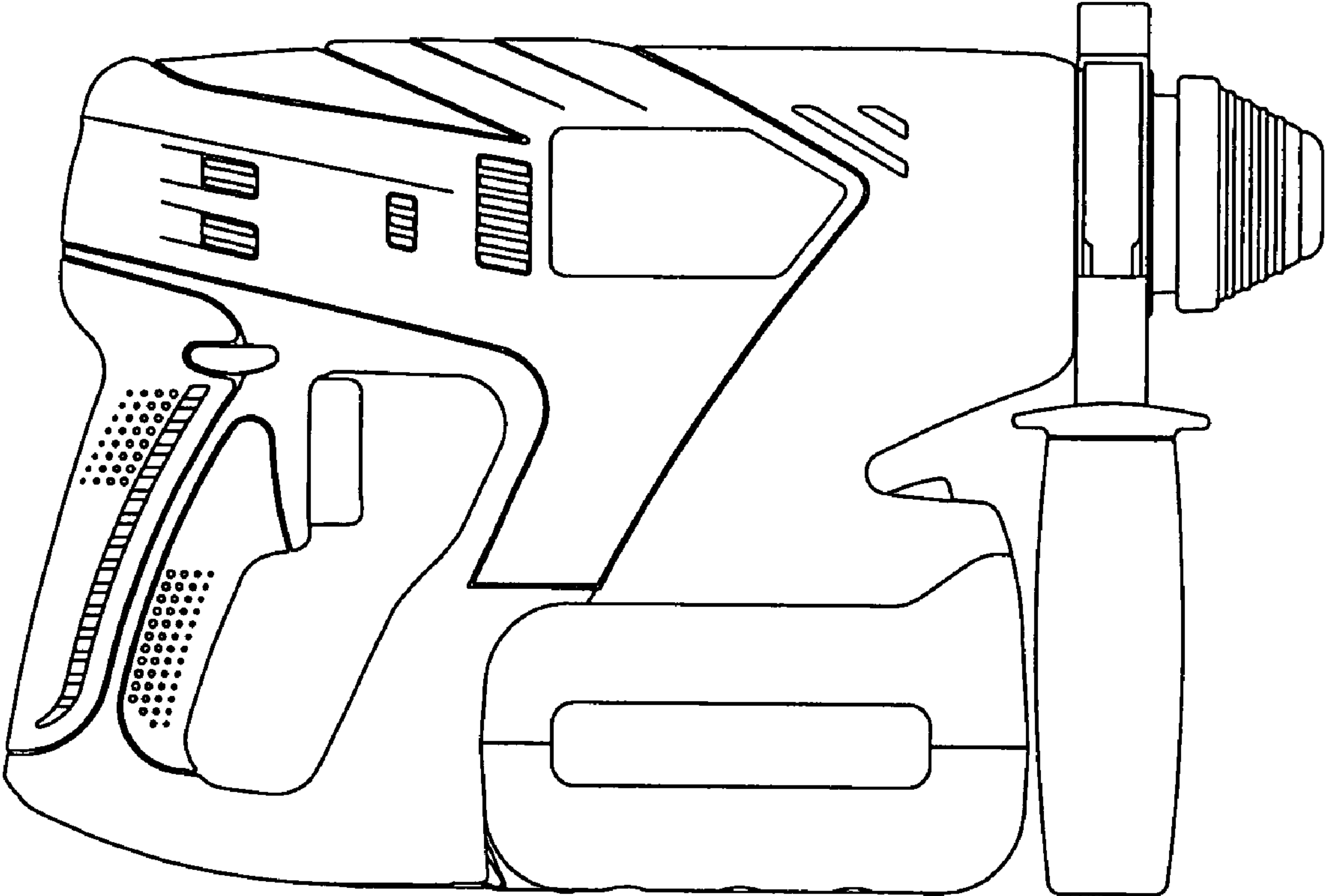

Fig. 4

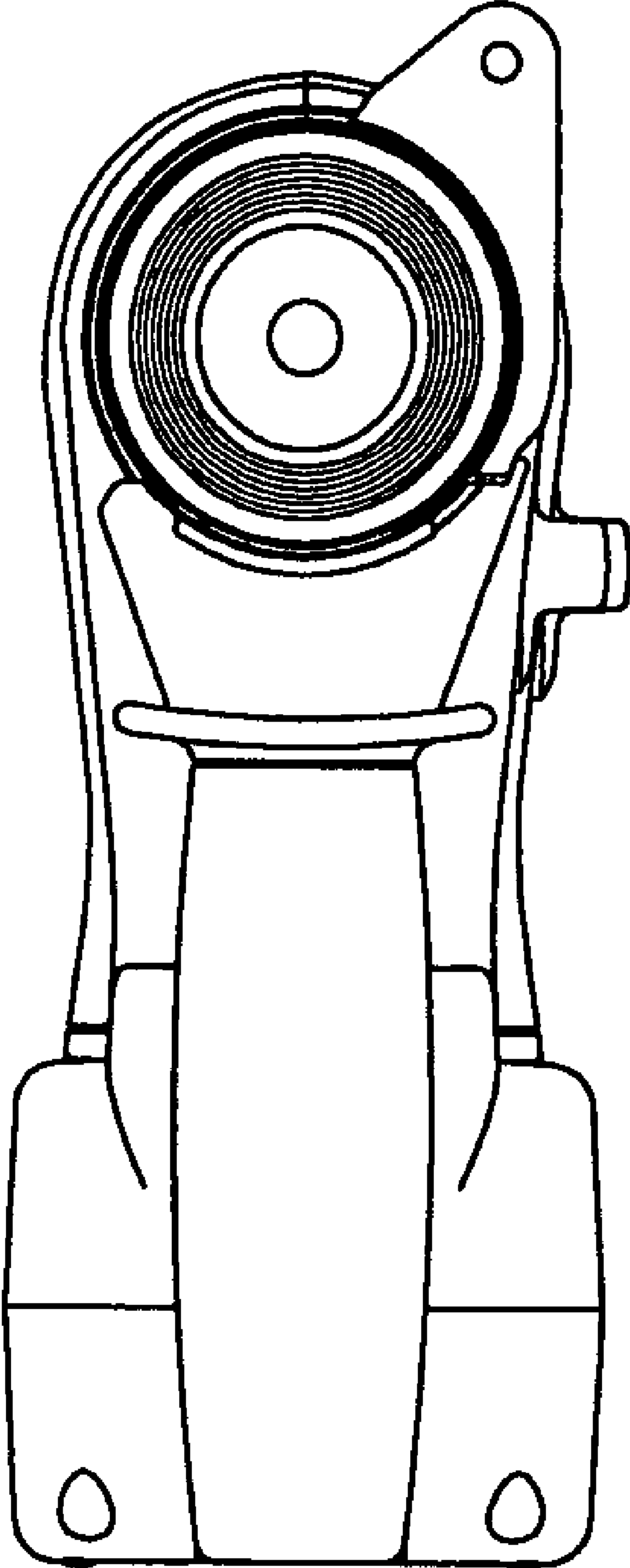

Fig. 5

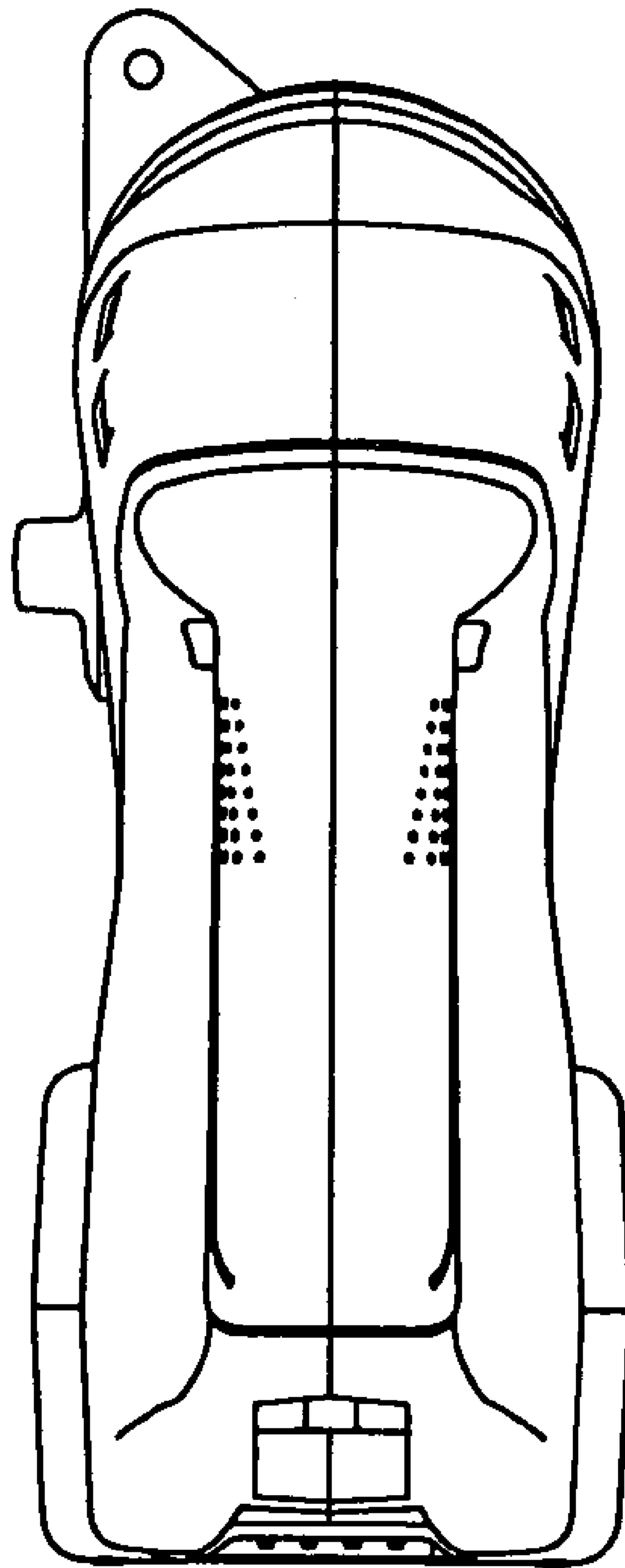

Fig. 6

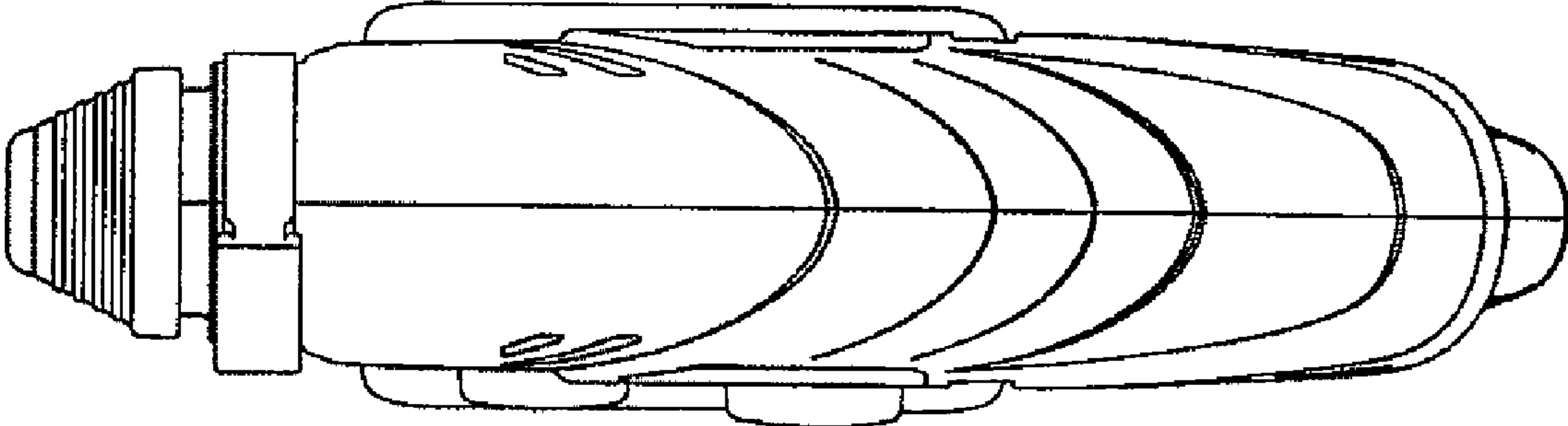

Fig. 7

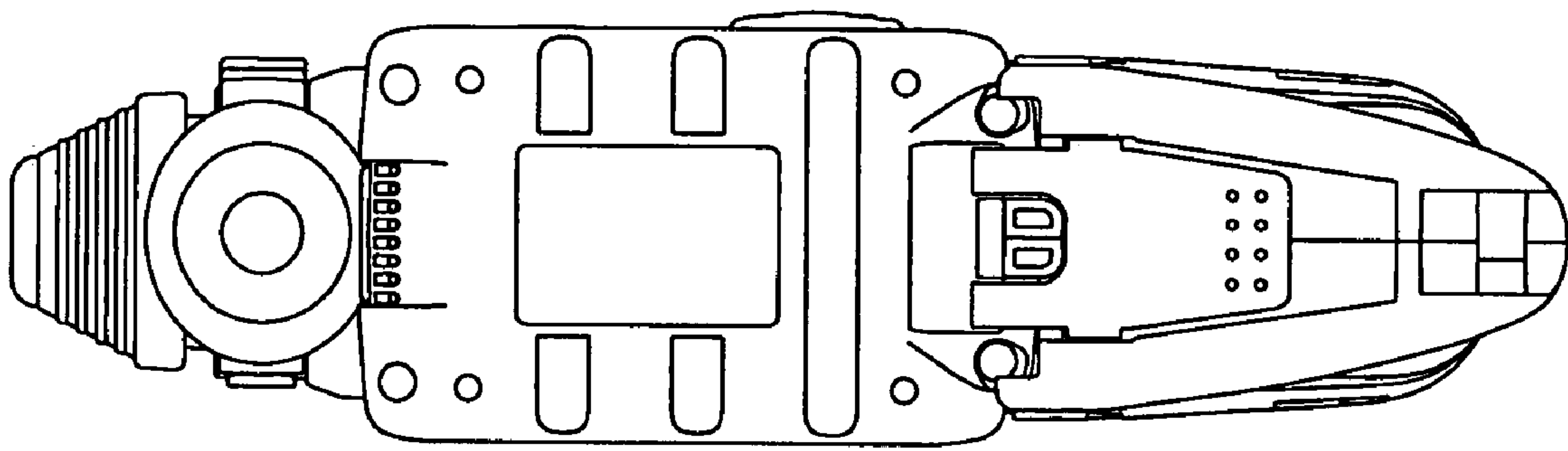

Fig. 8

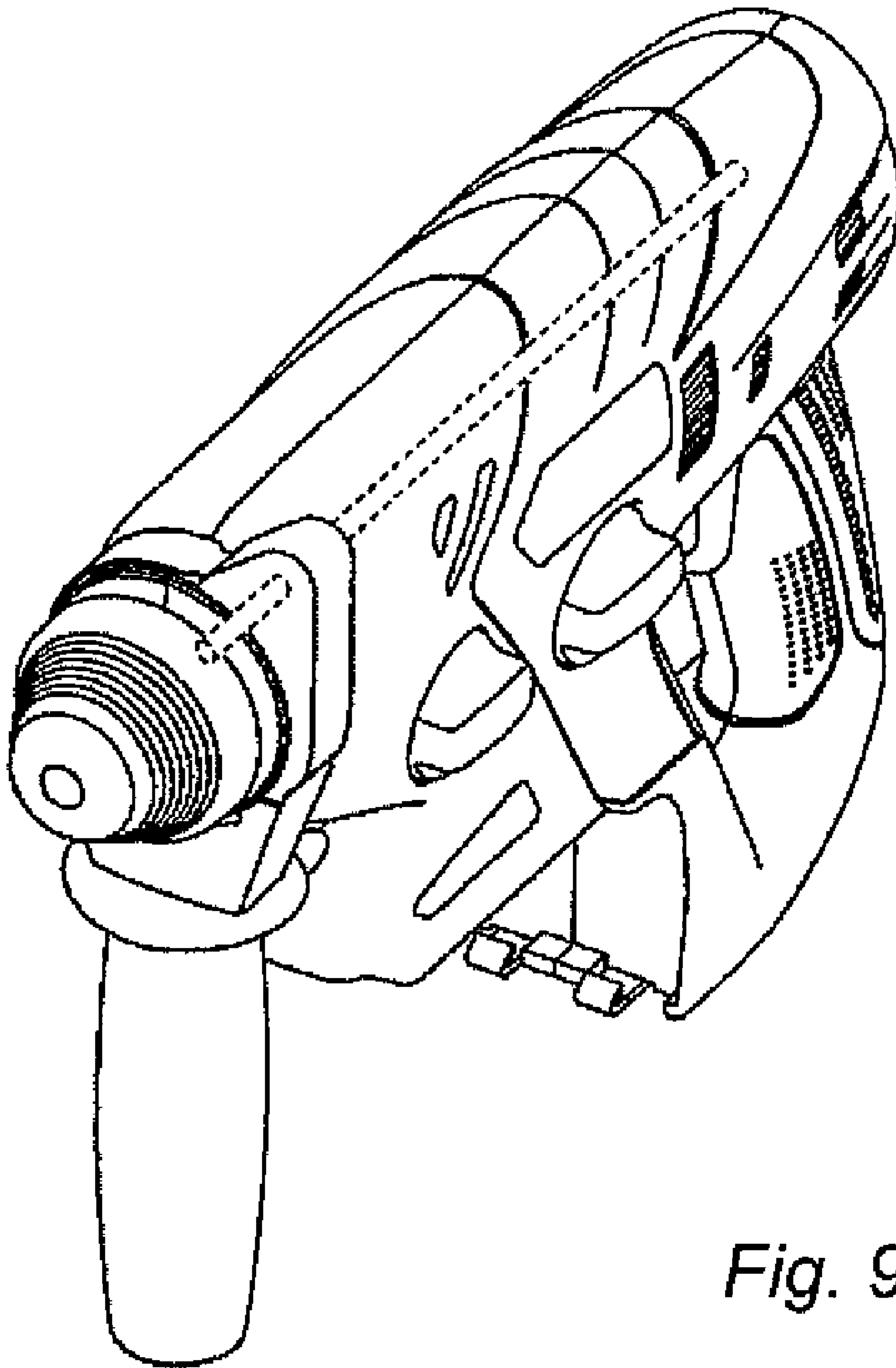

Fig. 9

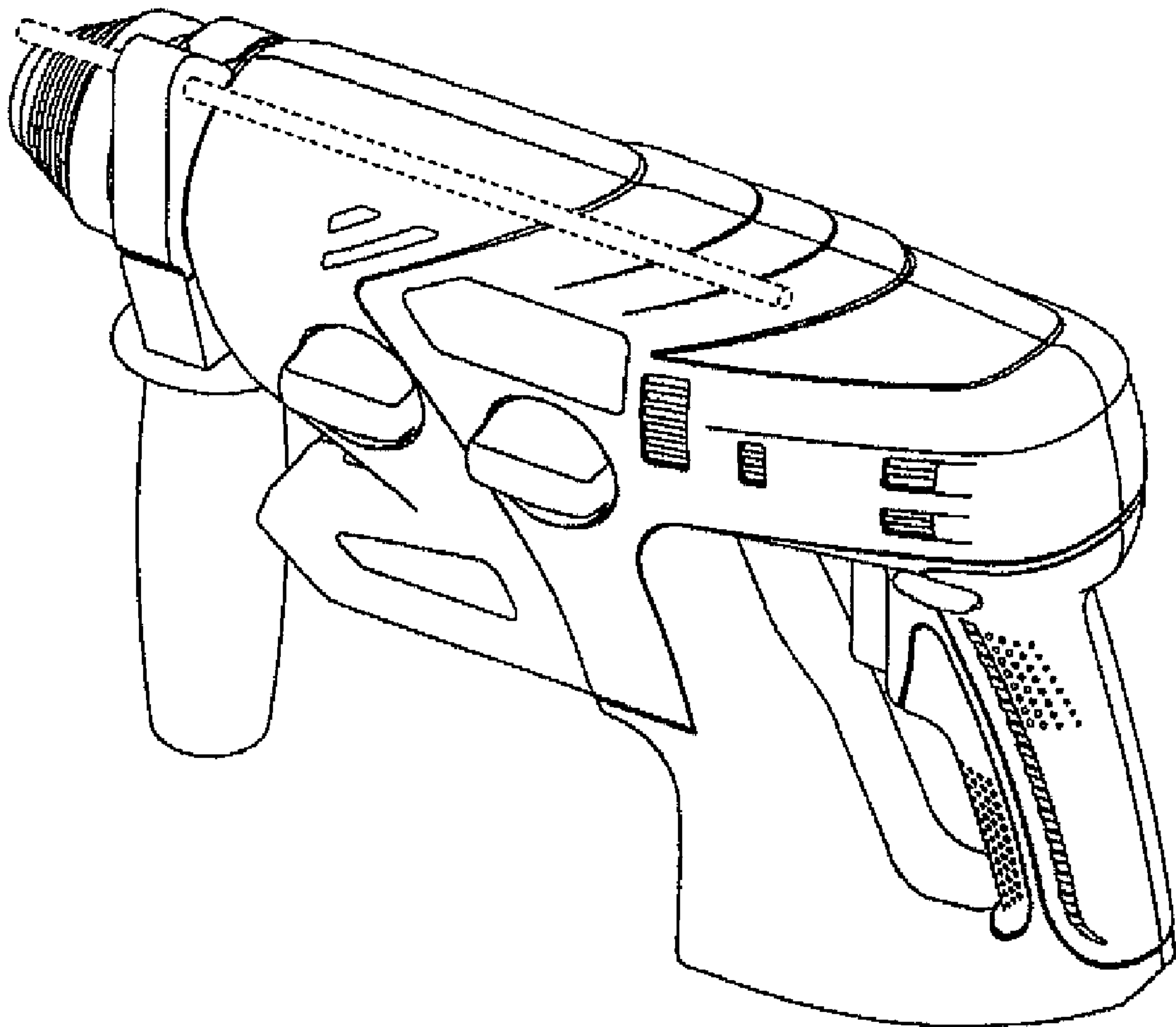

Fig. 10