



US00D577539S

(12) **United States Design Patent**
Cuillery

(10) **Patent No.:** **US D577,539 S**

(45) **Date of Patent:** **** Sep. 30, 2008**

(54) **STEAM KNOB FOR COOKING UTENSIL**

(75) Inventor: **Pascal Cuillery**, Faverges (FR)

(73) Assignee: **Tefal**, Rumilly (FR)

(**) Term: **14 Years**

(21) Appl. No.: **29/298,491**

(22) Filed: **Dec. 6, 2007**

(30) **Foreign Application Priority Data**

Jun. 8, 2007 (FR) 07 2667

(51) **LOC (8) Cl.** **07-02**

(52) **U.S. Cl.** **D7/393**

(58) **Field of Classification Search** D7/354-361,
D7/391, 393; D8/300, 301, 307, 310, 312,
D8/319, 320; 220/752; 16/110.1, 410, 417,
16/441, 443

See application file for complete search history.

(56) **References Cited**

U.S. PATENT DOCUMENTS

D225,204 S * 11/1972 Marron D8/311
D371,486 S * 7/1996 Chan D7/393
D384,241 S * 9/1997 Brasset D7/391
D398,811 S * 9/1998 Montgelard D7/391

D461,993 S * 8/2002 Coudurier D7/393
D532,250 S * 11/2006 Roussard D7/358
D534,031 S * 12/2006 Roussard D7/358
D539,077 S * 3/2007 Roussard D7/358
D543,772 S * 6/2007 Roussard D7/358

* cited by examiner

Primary Examiner—Holly H. Baynham

Assistant Examiner—Cynthia M Chin

(74) *Attorney, Agent, or Firm*—Young & Thompson

(57) **CLAIM**

The ornamental design for a steam knob for cooking utensil, as shown and described.

DESCRIPTION

FIG. 1 is a top and side perspective view of a steam knob for cooking utensil, showing my new design;

FIG. 2 is a front elevational view thereof;

FIG. 3 is a top plan view thereof;

FIG. 4 is a bottom plan view thereof;

FIG. 5 is an enlarged side elevational view thereof from the right of FIG. 2, the opposite side elevational view being the mirror image thereof; and,

FIG. 6 is a rear elevational view thereof.

1 Claim, 6 Drawing Sheets

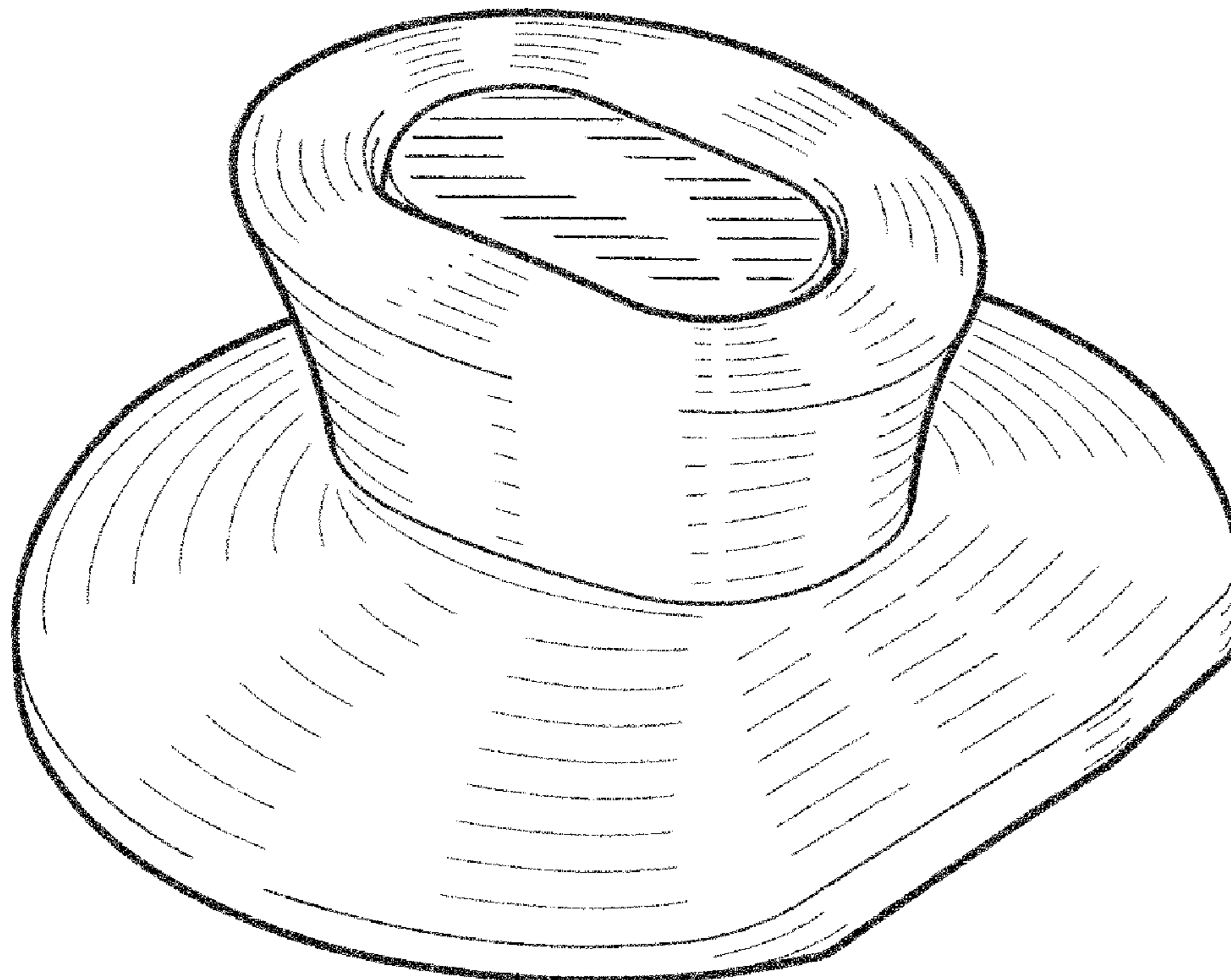

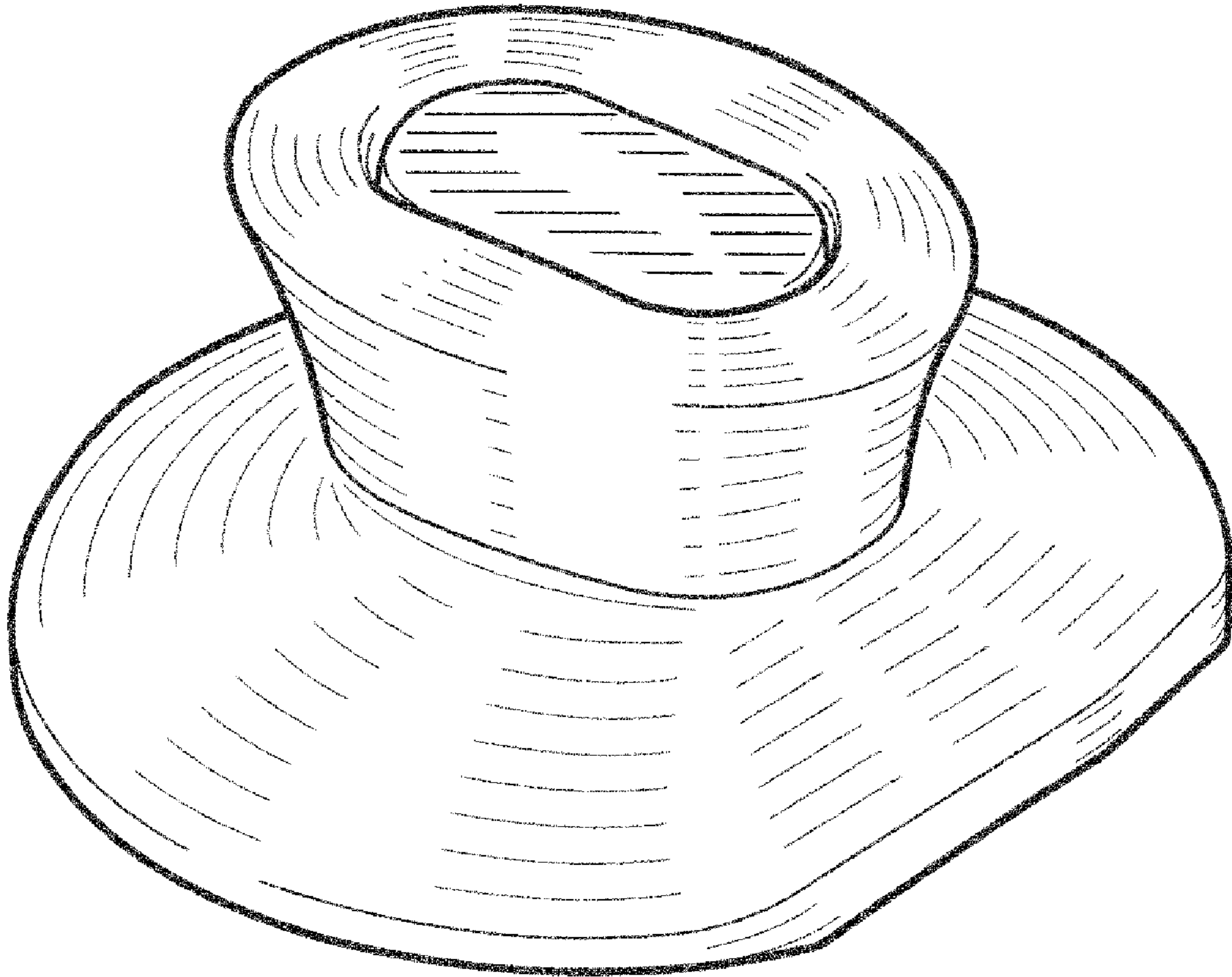

Fig. 1

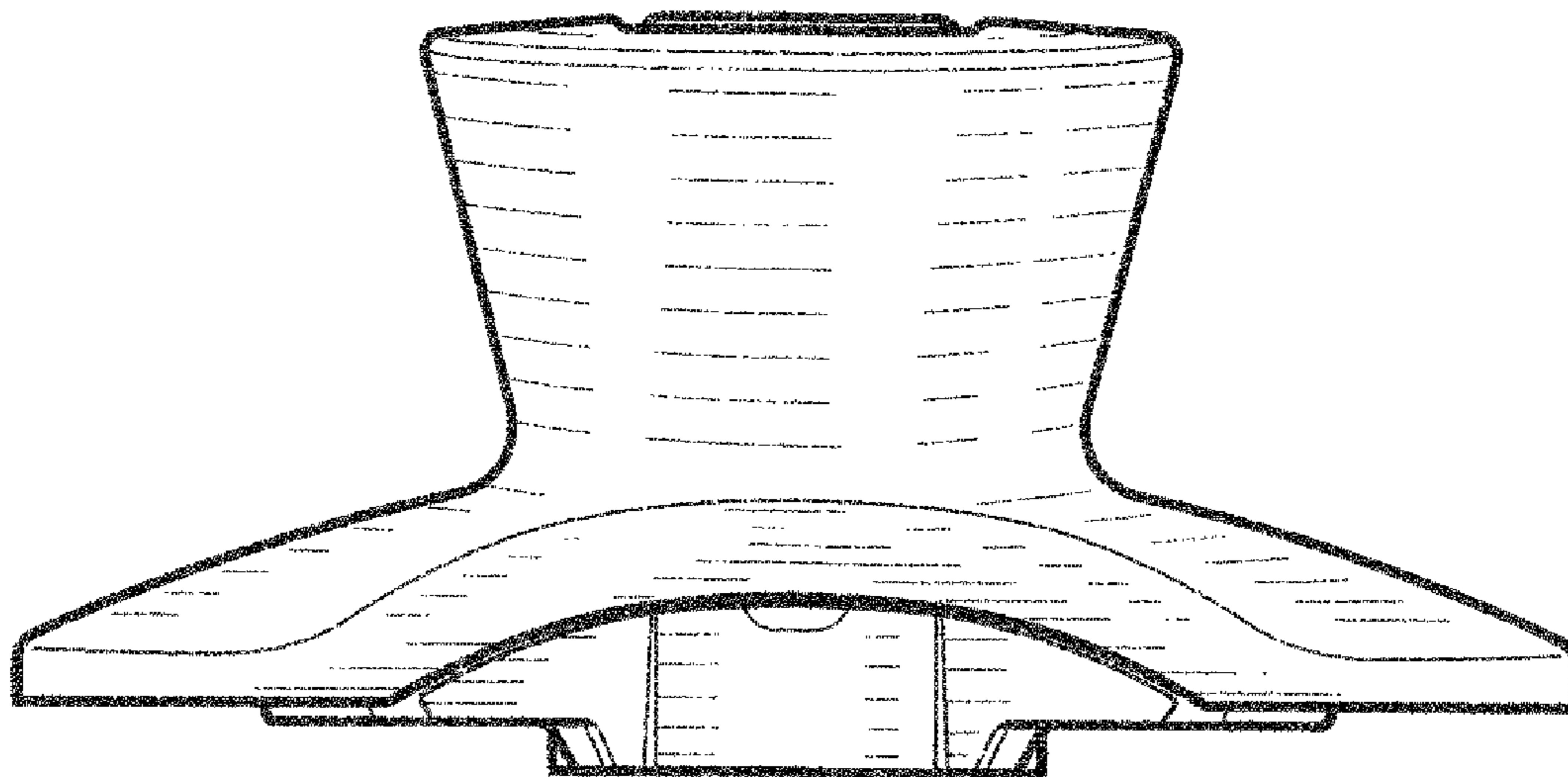

Fig. 2

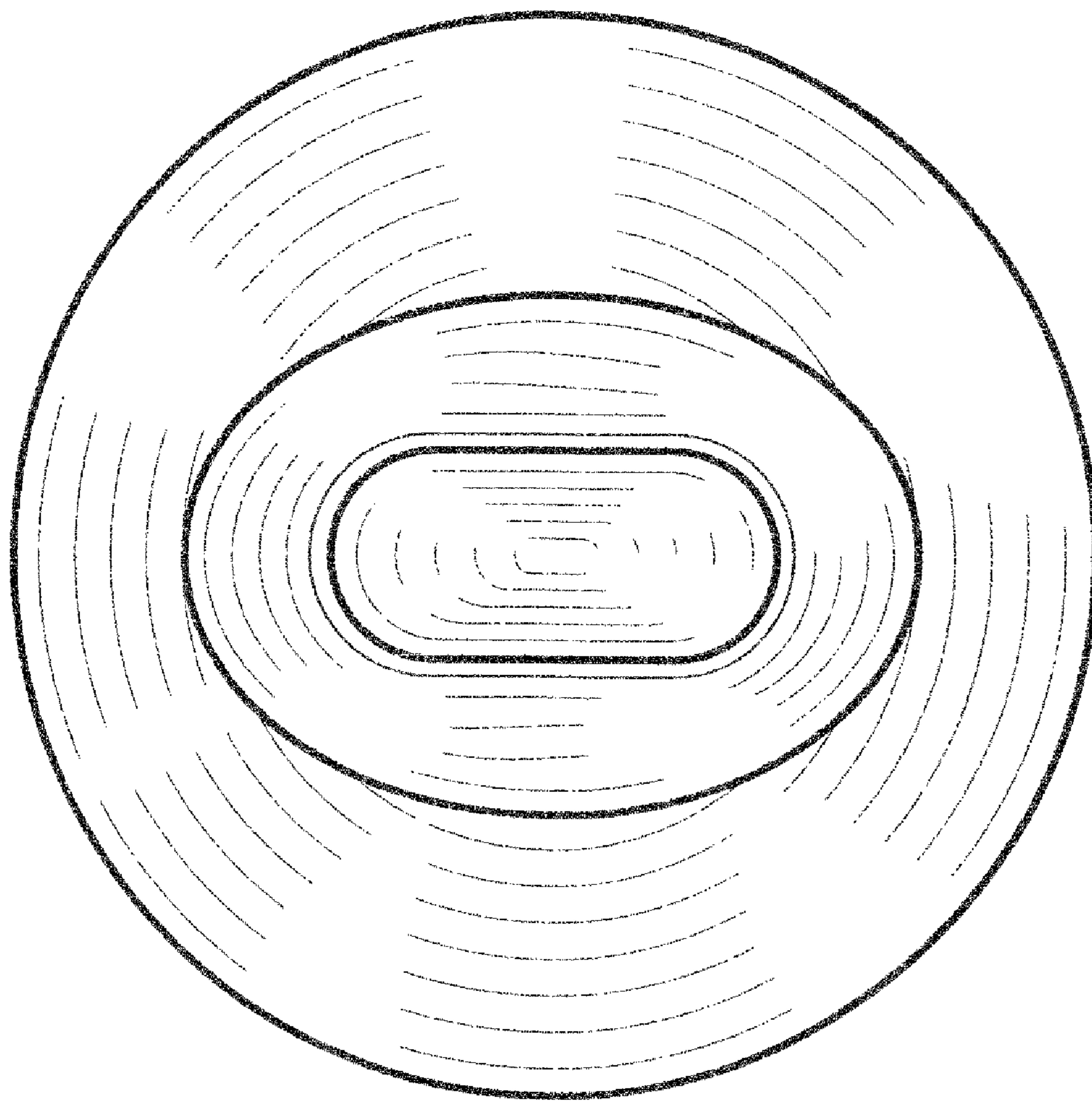

Fig. 3

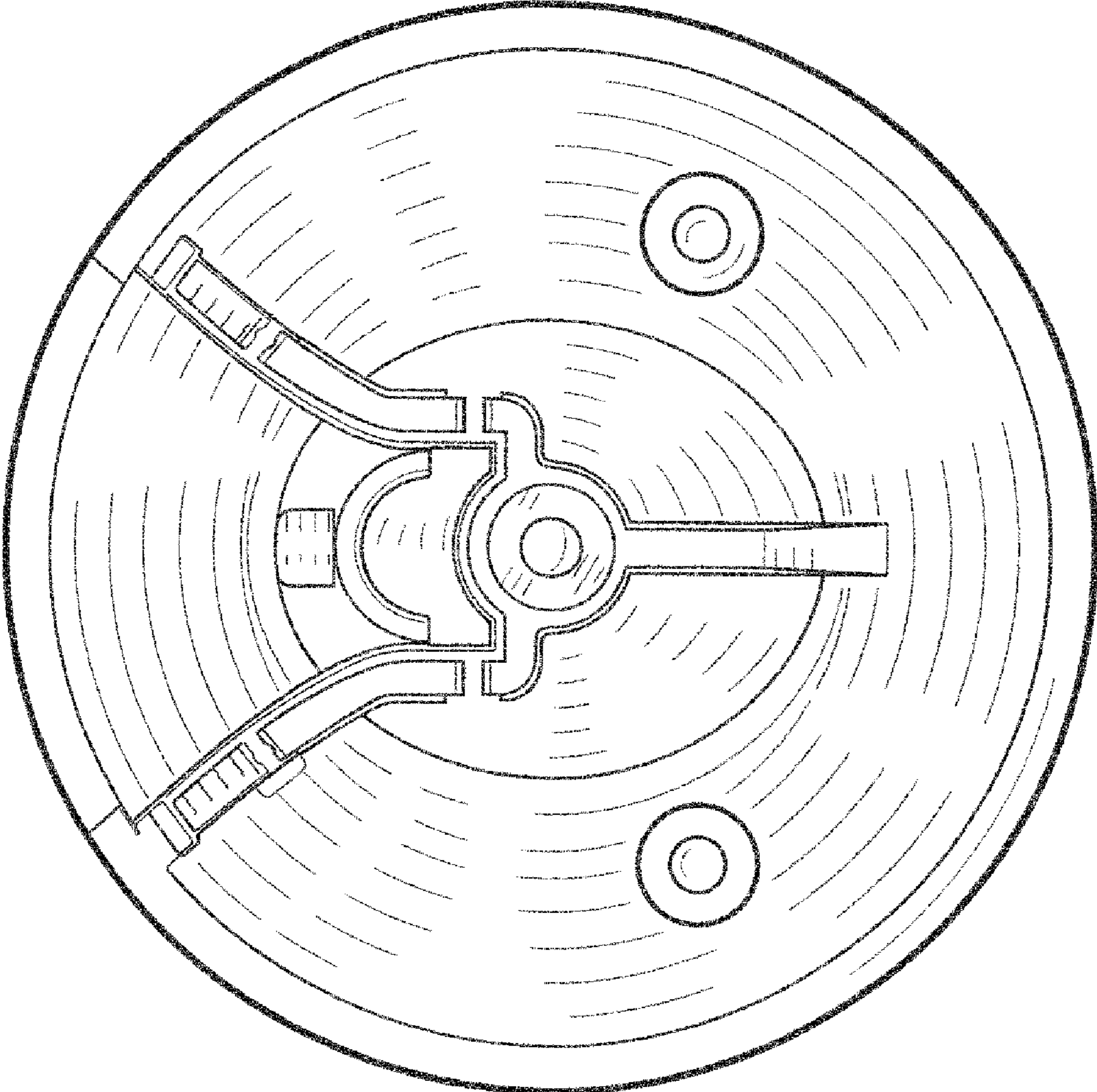

Fig. 4

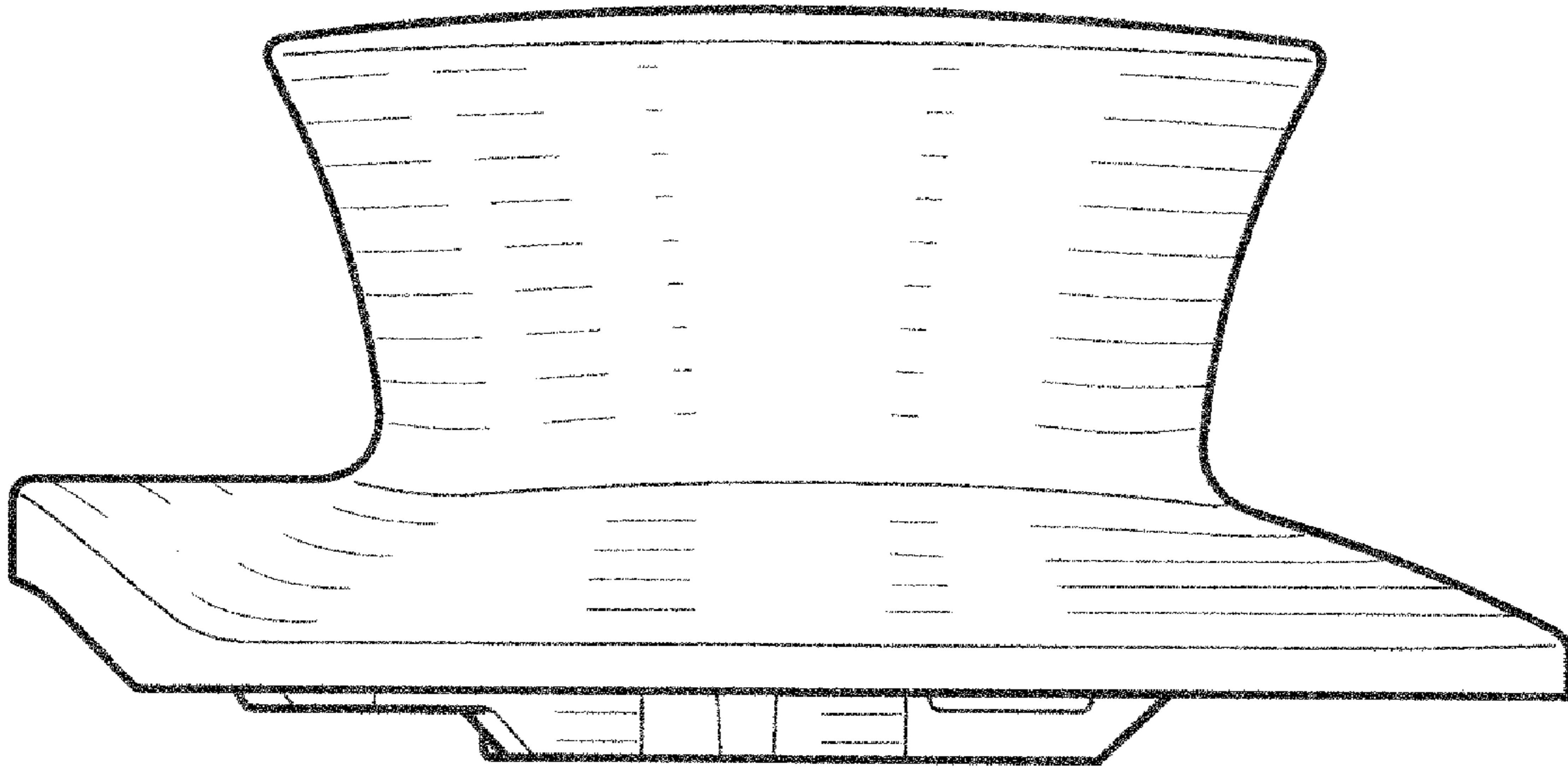

Fig. 5

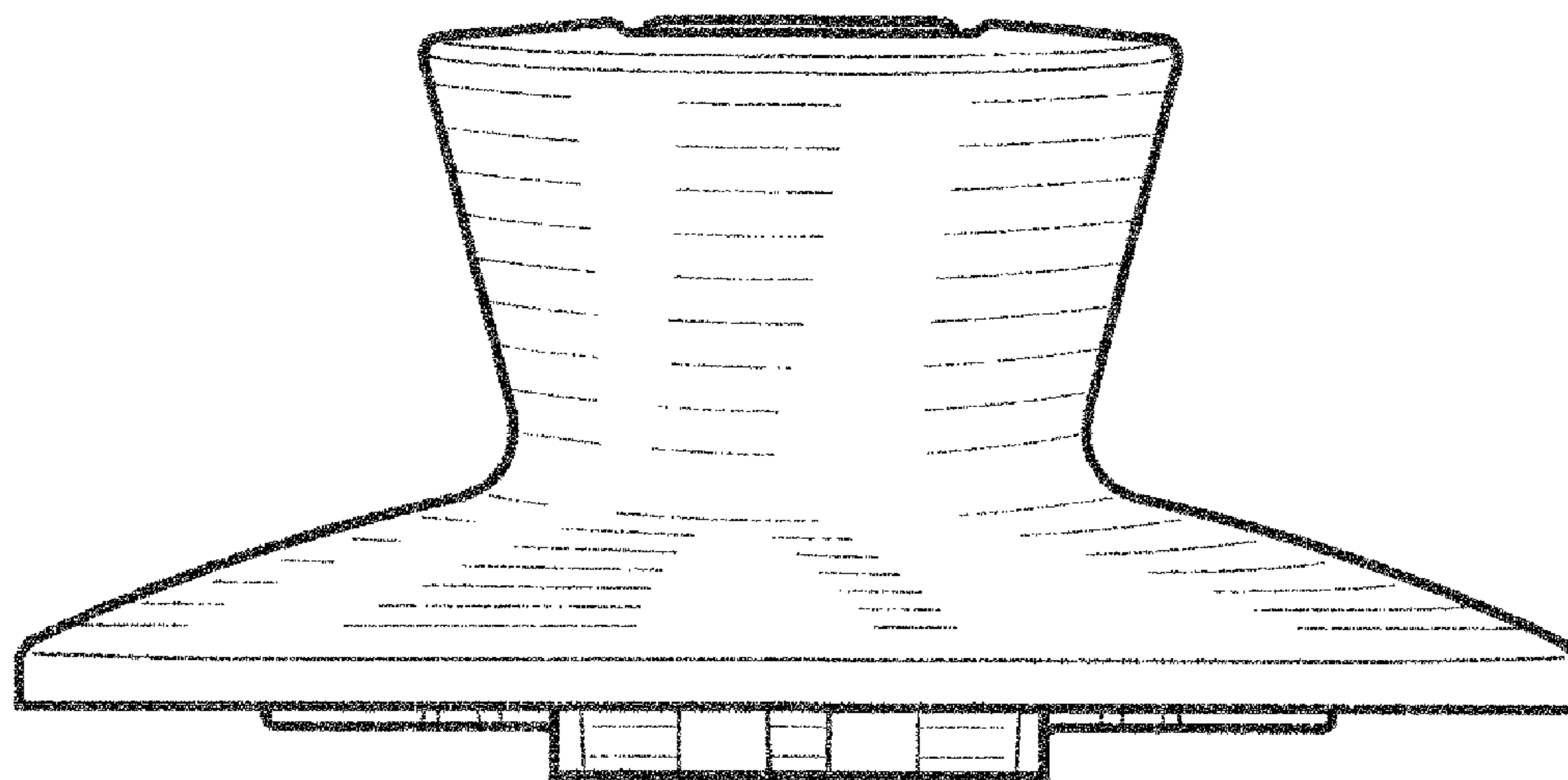

Fig. 6