



US00D577519S

(12) **United States Design Patent**
Su

(10) **Patent No.:** **US D577,519 S**

(45) **Date of Patent:** **** Sep. 30, 2008**

(54) **CHAIR BACKREST**

(76) **Inventor:** **Tung-Hua Su**, No. 6, Sec. 3, Bao Ta Road, Kuwi Jen Hsiang, Tainan Hsien (TW) 711

(**) **Term:** **14 Years**

(21) **Appl. No.:** **29/296,384**

(22) **Filed:** **Oct. 18, 2007**

(51) **LOC (8) Cl.** **06-01**

(52) **U.S. Cl.** **D6/502; D6/366**

(58) **Field of Classification Search** D6/334-336, D6/364, 365, 366, 367, 369, 379, 380, 500-502; 297/284.4, 300.2, 411.27, 411.36, 452.13, 297/452.29, 452.46, 452.56, 452.64
See application file for complete search history.

(56) **References Cited**

U.S. PATENT DOCUMENTS

D540,081 S * 4/2007 Su D6/502
D540,579 S * 4/2007 Su D6/502
D540,580 S * 4/2007 Su D6/502

D544,735 S * 6/2007 Su D6/502
D553,886 S * 10/2007 Su D6/502
D557,028 S * 12/2007 Su D6/366

* cited by examiner

Primary Examiner—Mimosa De

(74) *Attorney, Agent, or Firm*—Banger Shia

(57) **CLAIM**

The ornamental design for a chair backrest, as shown and described.

DESCRIPTION

FIG. 1 is a perspective view of a chair backrest showing my new design;

FIG. 2 is a front elevation view thereof;

FIG. 3 is a rear elevation view thereof;

FIG. 4 is a left side elevation view thereof;

FIG. 5 is a right side elevation view thereof;

FIG. 6 is a top plan view thereof; and,

FIG. 7 is a bottom plan view thereof.

1 Claim, 6 Drawing Sheets

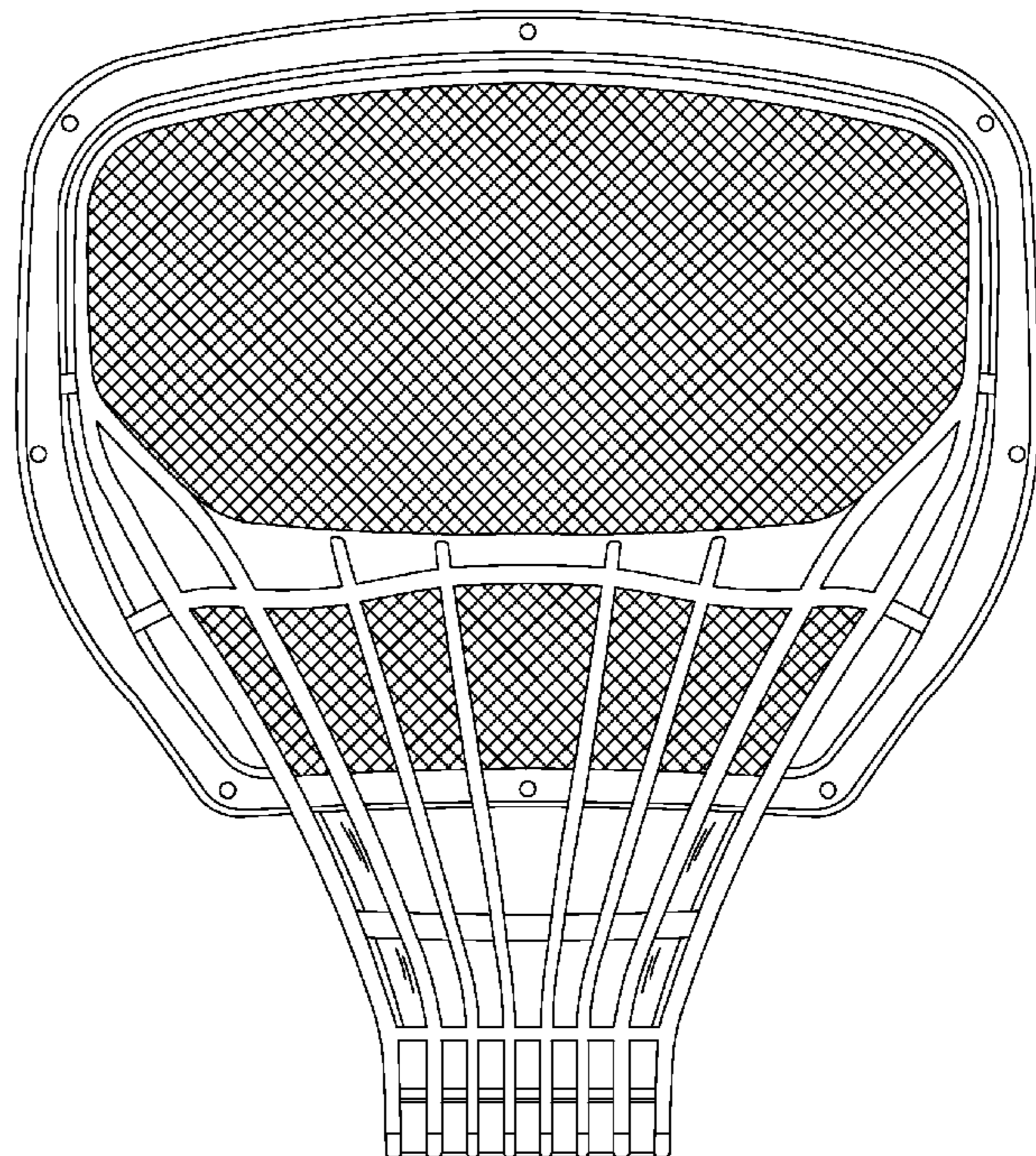
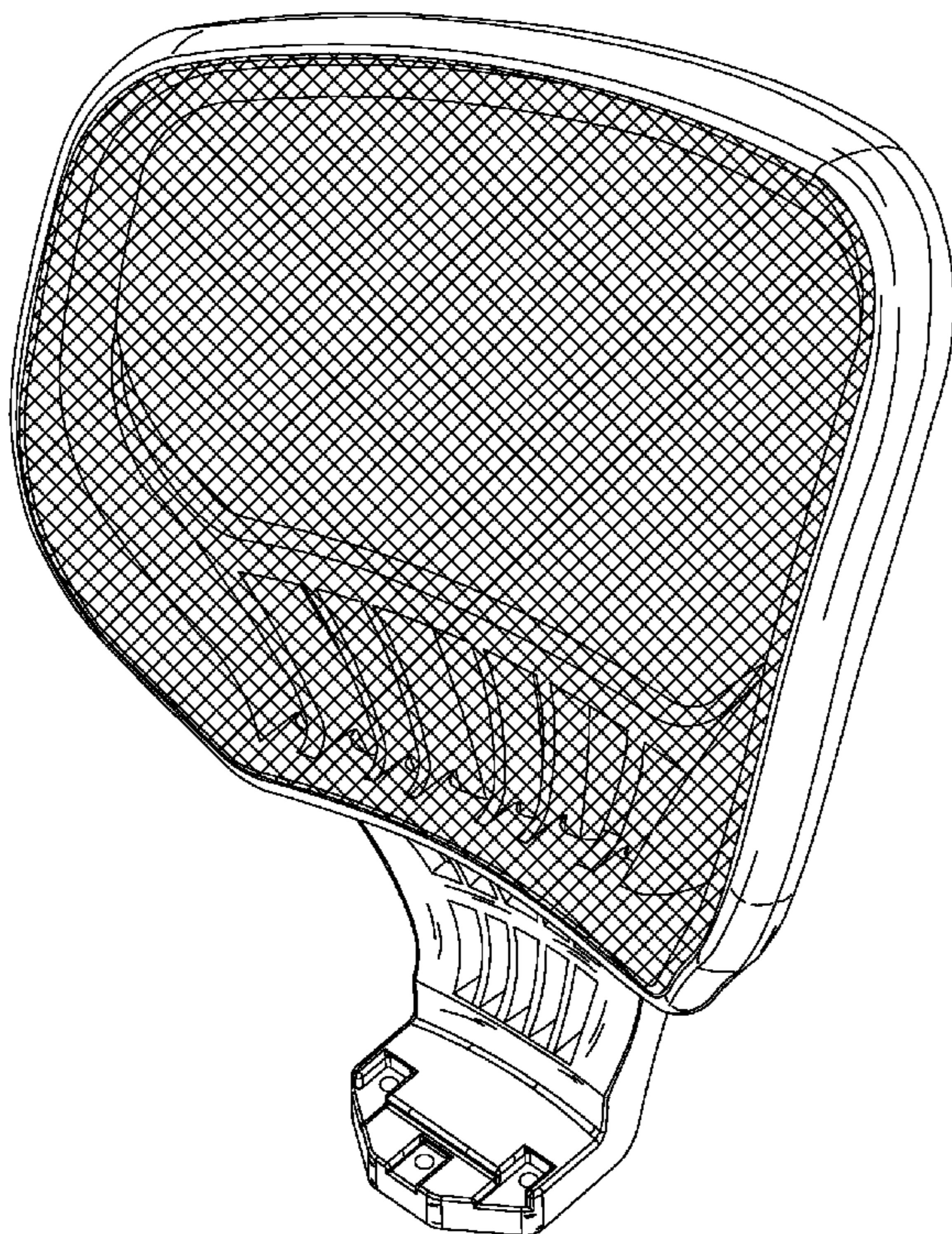

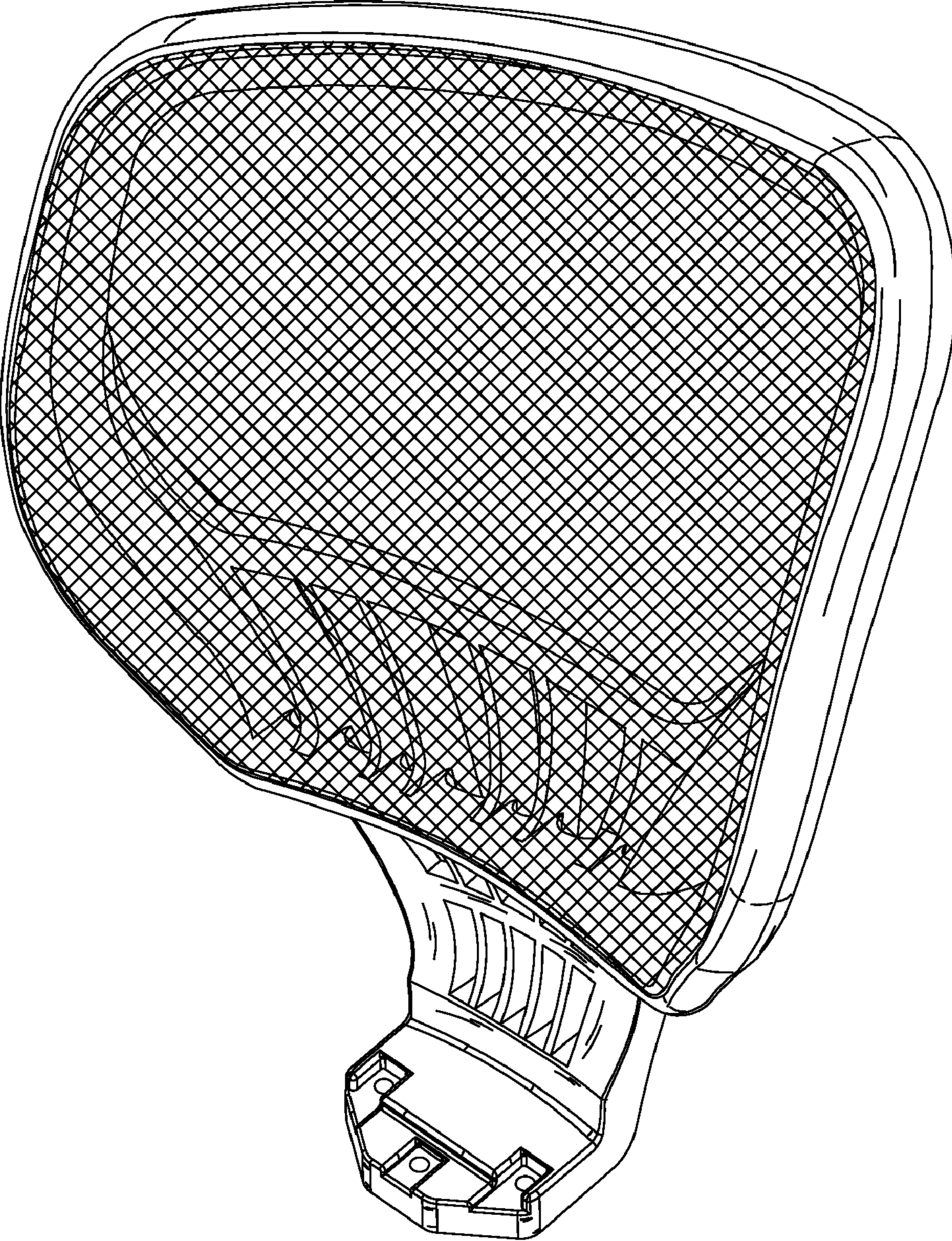

F I G . 1

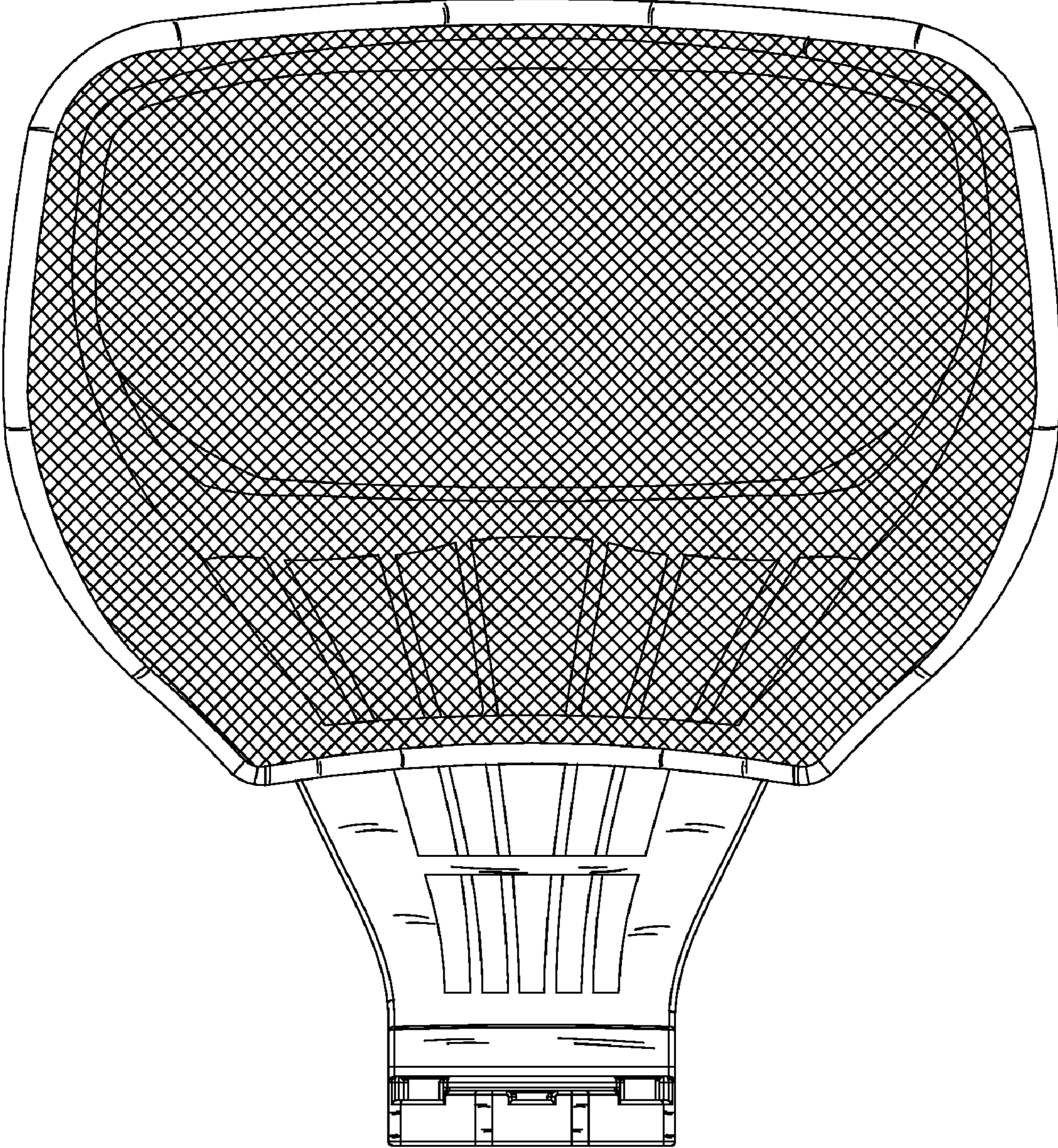

F I G . 2

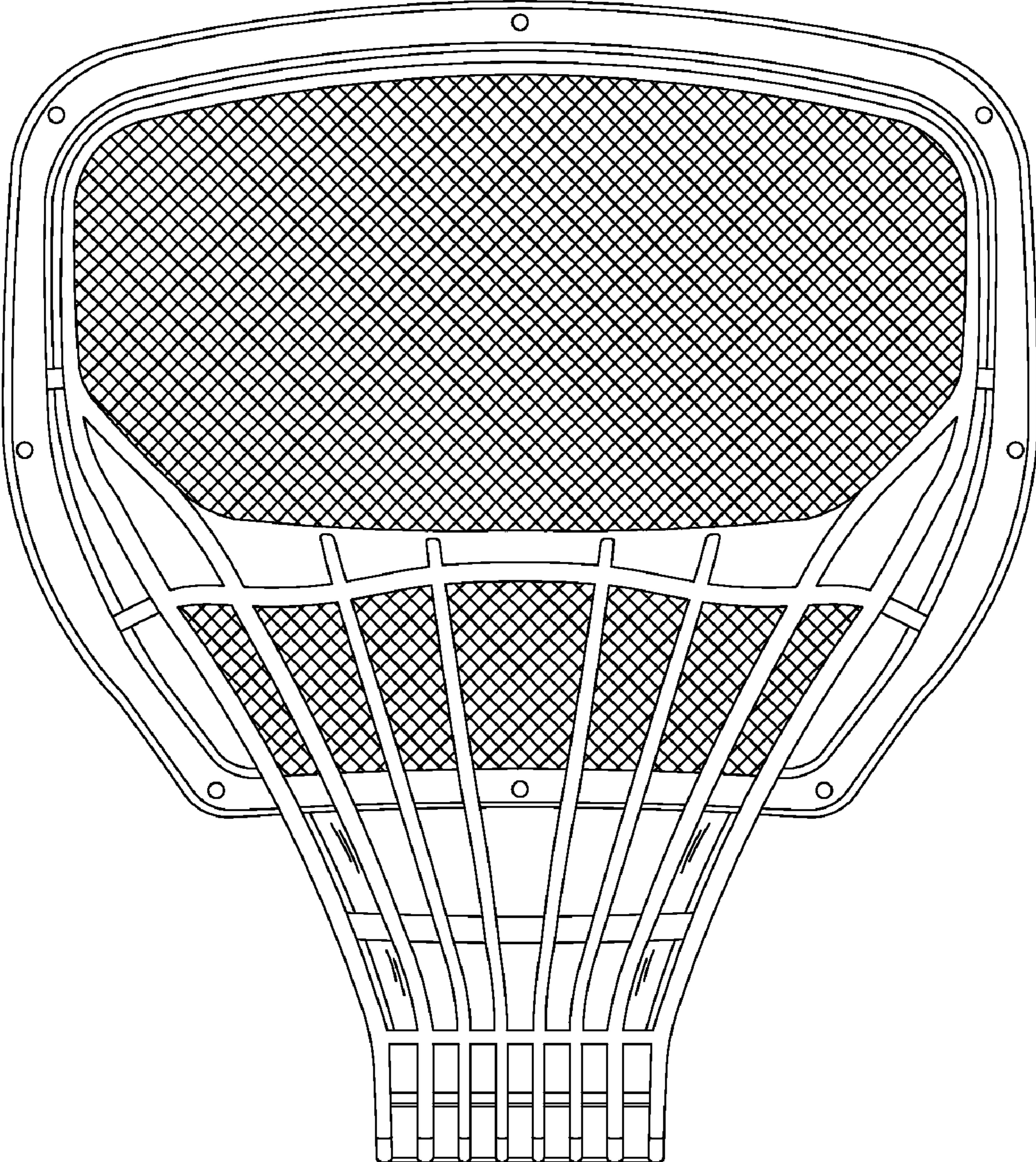

F I G . 3

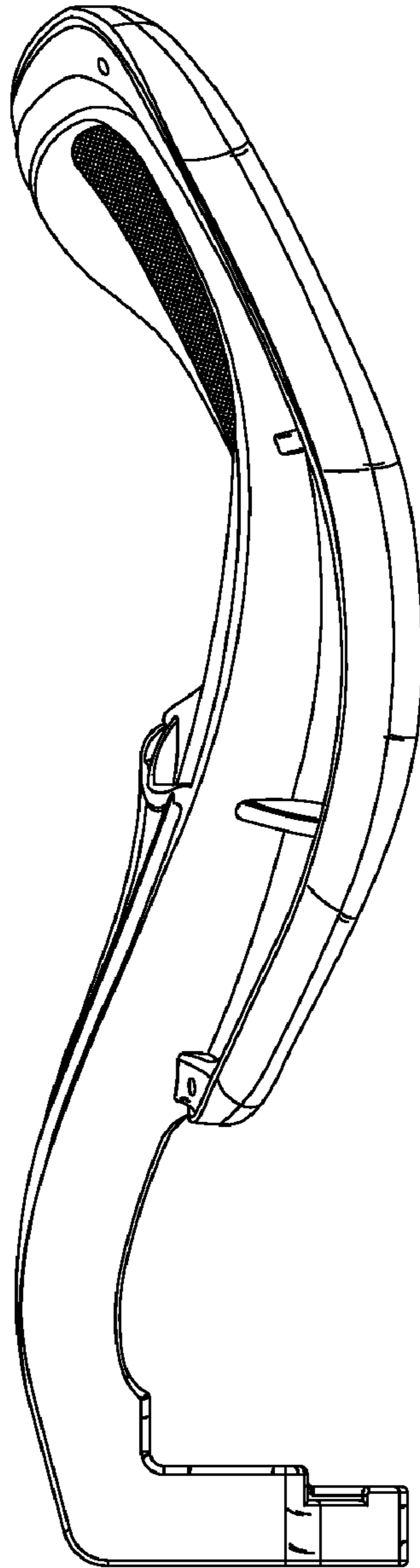

F I G . 4

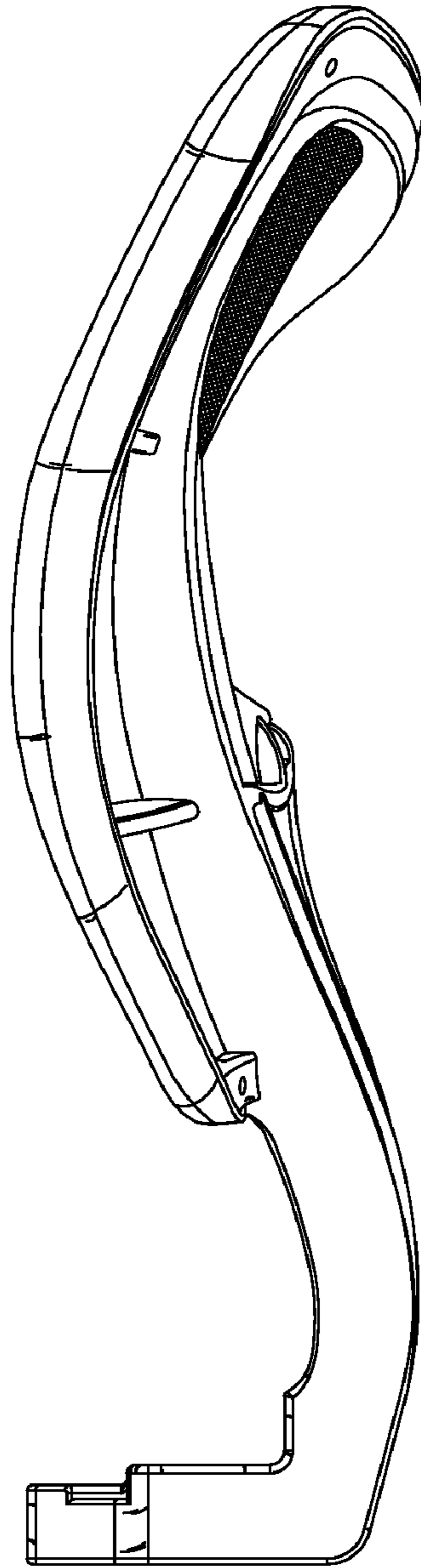

F I G . 5

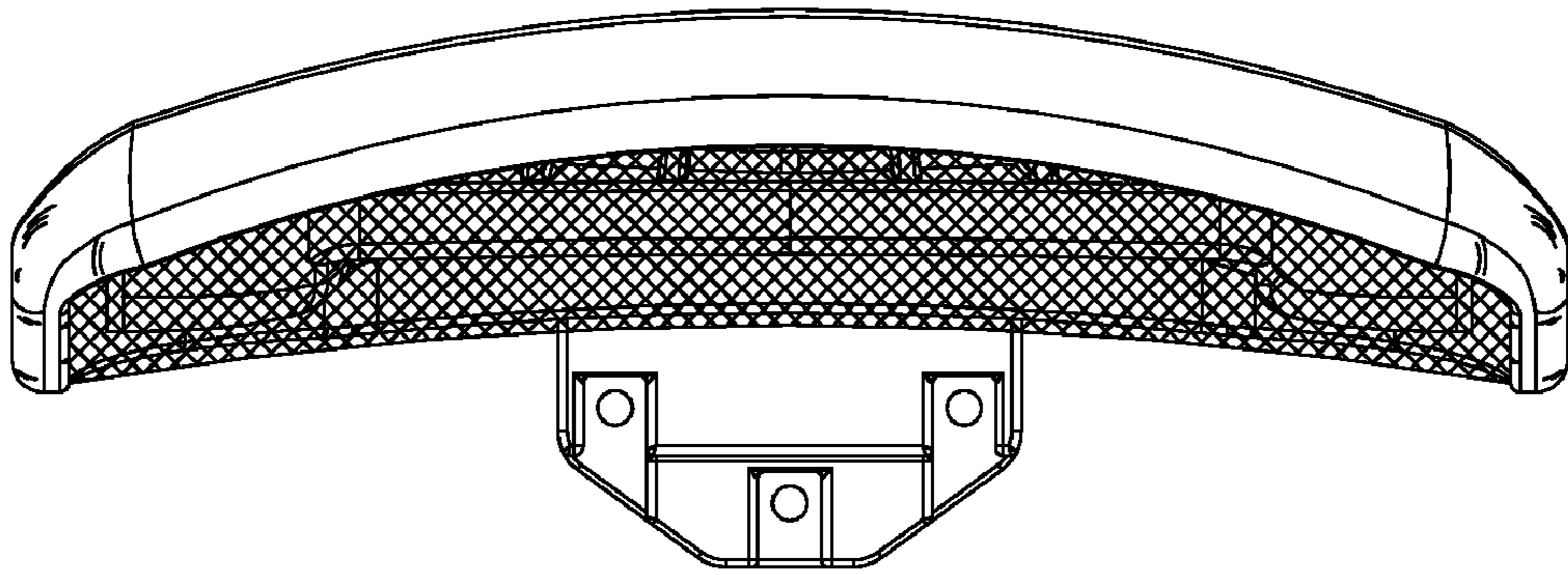

F I G . 6

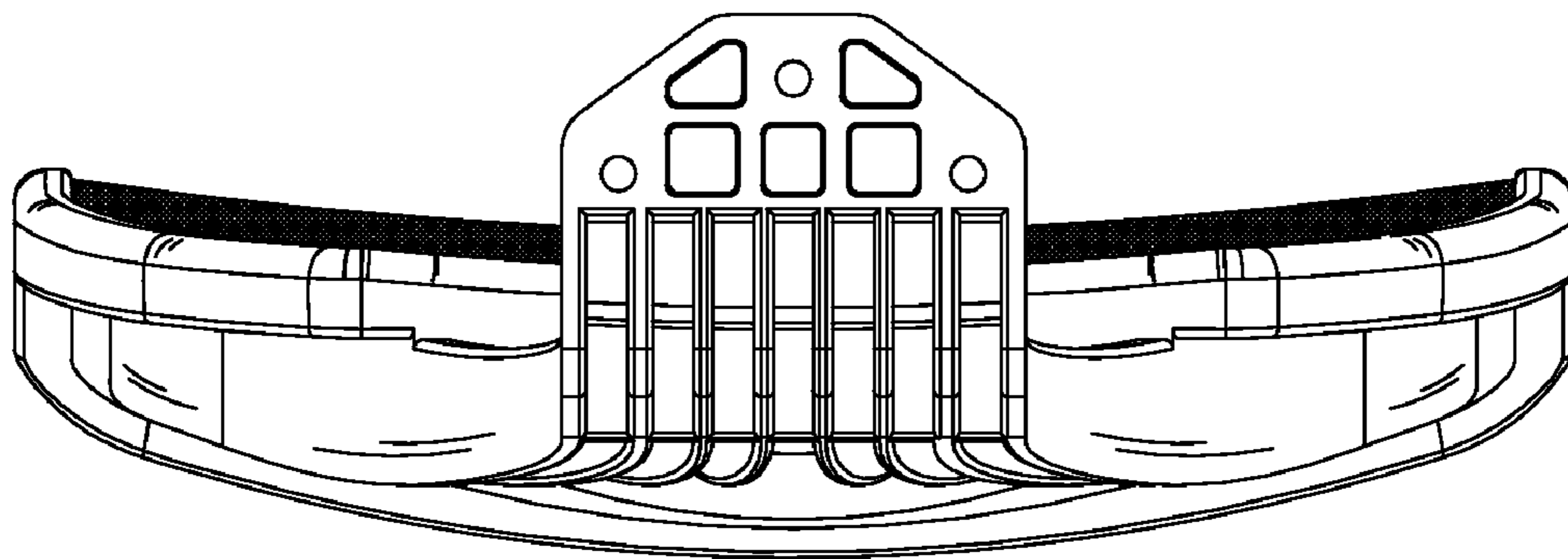

F I G . 7