



US00D577499S

(12) **United States Design Patent**
Tsay et al.

(10) **Patent No.:** **US D577,499 S**
(45) **Date of Patent:** **** Sep. 30, 2008**

(54) **VEHICLE SEAT**

(75) Inventors: **Michael Tsay**, Irvine, CA (US); **Frank Moburg**, Orange, CA (US); **Nicholas Green**, Los Angeles, CA (US); **Toshi Sase**, Raymond, OH (US)

(73) Assignee: **Honda Motor Co., Ltd.**, Tokyo (JP)

(**) Term: **14 Years**

(21) Appl. No.: **29/295,081**

(22) Filed: **Sep. 21, 2007**

(51) **LOC (8) Cl.** **06-01**

(52) **U.S. Cl.** **D6/356**

(58) **Field of Classification Search** D6/334-336,
D6/356, 367, 368, 374, 375, 500-502; 297/232,
297/353, 354.1, 391, 396, 452.21, 452.24,
297/452.25, 452.26, 452.29, 452.34, 452.35
See application file for complete search history.

(56) **References Cited**

U.S. PATENT DOCUMENTS

D273,920 S * 5/1984 Tixier D6/356
D460,279 S * 7/2002 Moburg D6/356
D465,344 S * 11/2002 Siegert D6/356

D504,242 S * 4/2005 Schowalter et al. D6/356
D504,785 S * 5/2005 Beermann et al. D6/356
D506,084 S * 6/2005 Beermann et al. D6/356
D507,122 S * 7/2005 Beermann D6/356
D534,005 S * 12/2006 Beermann D6/356

* cited by examiner

Primary Examiner—Mimosa De

(74) *Attorney, Agent, or Firm*—Plumsea Law Group, LLC;
Mark E. Duell

(57) **CLAIM**

The ornamental design for a vehicle seat, as shown and described.

DESCRIPTION

FIG. 1 is a frontal perspective view of a vehicle seat showing my new design;

FIG. 2 is a rear perspective view thereof;

FIG. 3 is a front elevational view thereof;

FIG. 4 is a rear elevational view thereof;

FIG. 5 is a side elevational view of one side thereof;

FIG. 6 is a side elevational view of the other side thereof; and,

FIG. 7 is a top plan view thereof.

1 Claim, 5 Drawing Sheets

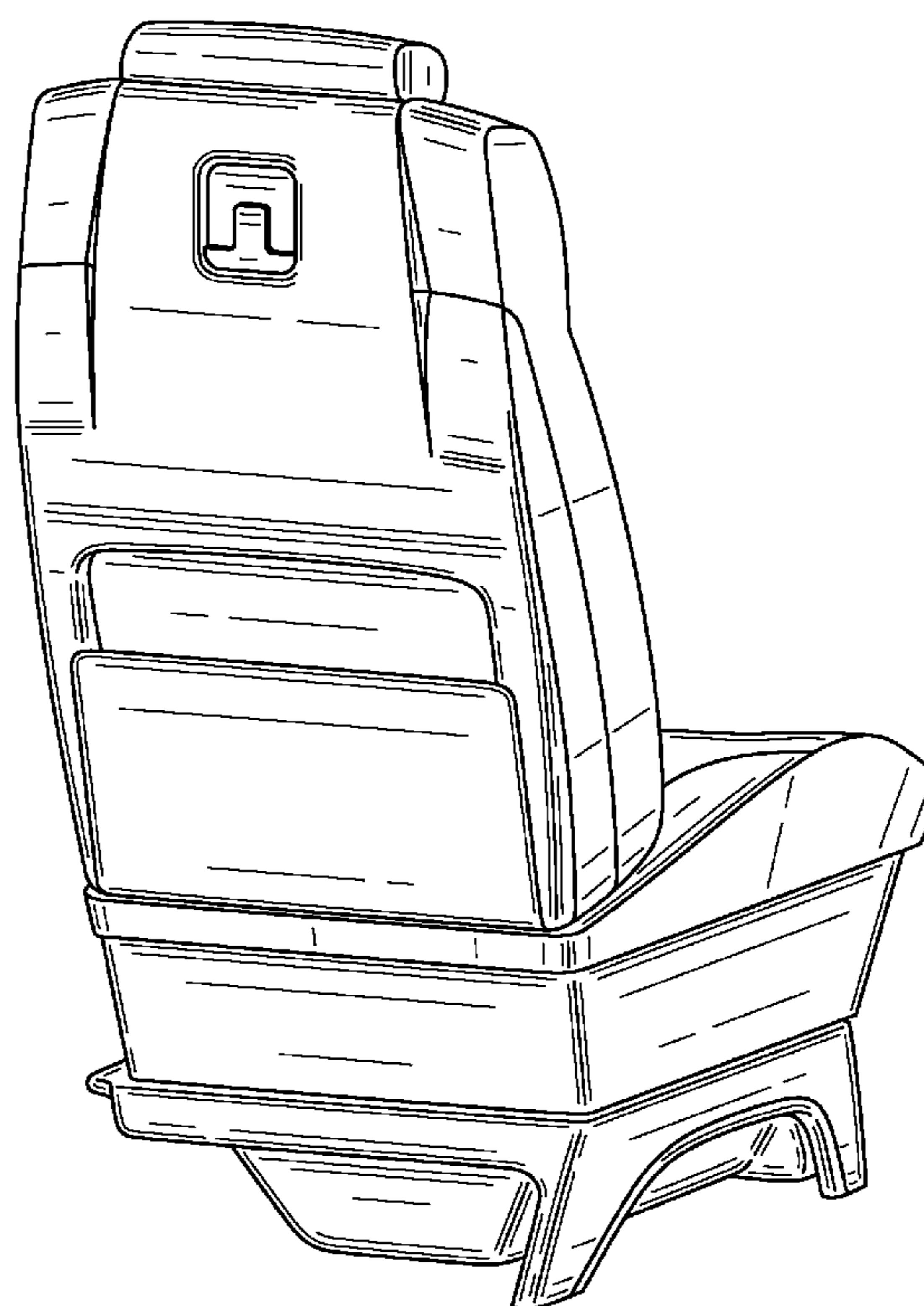
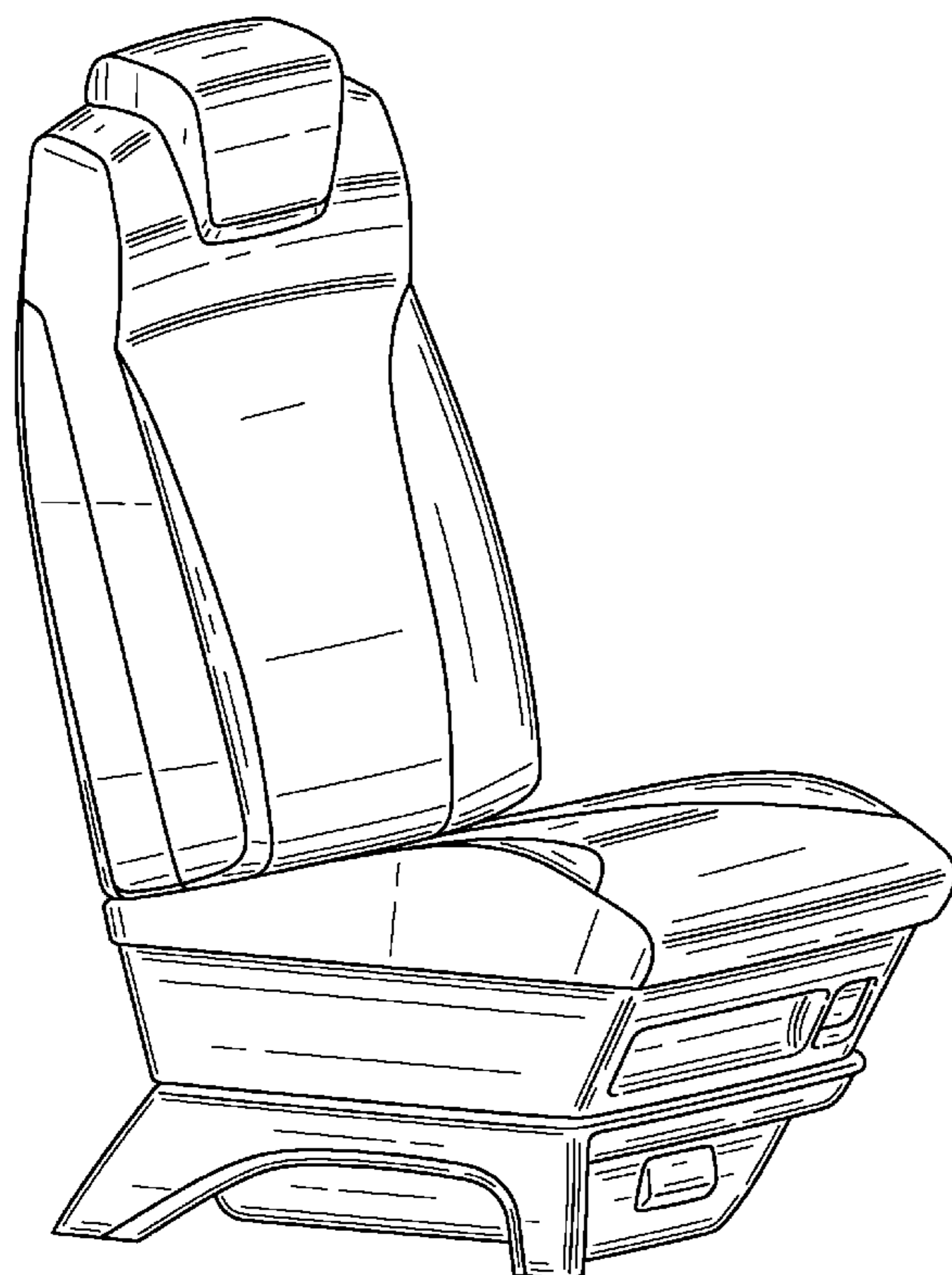

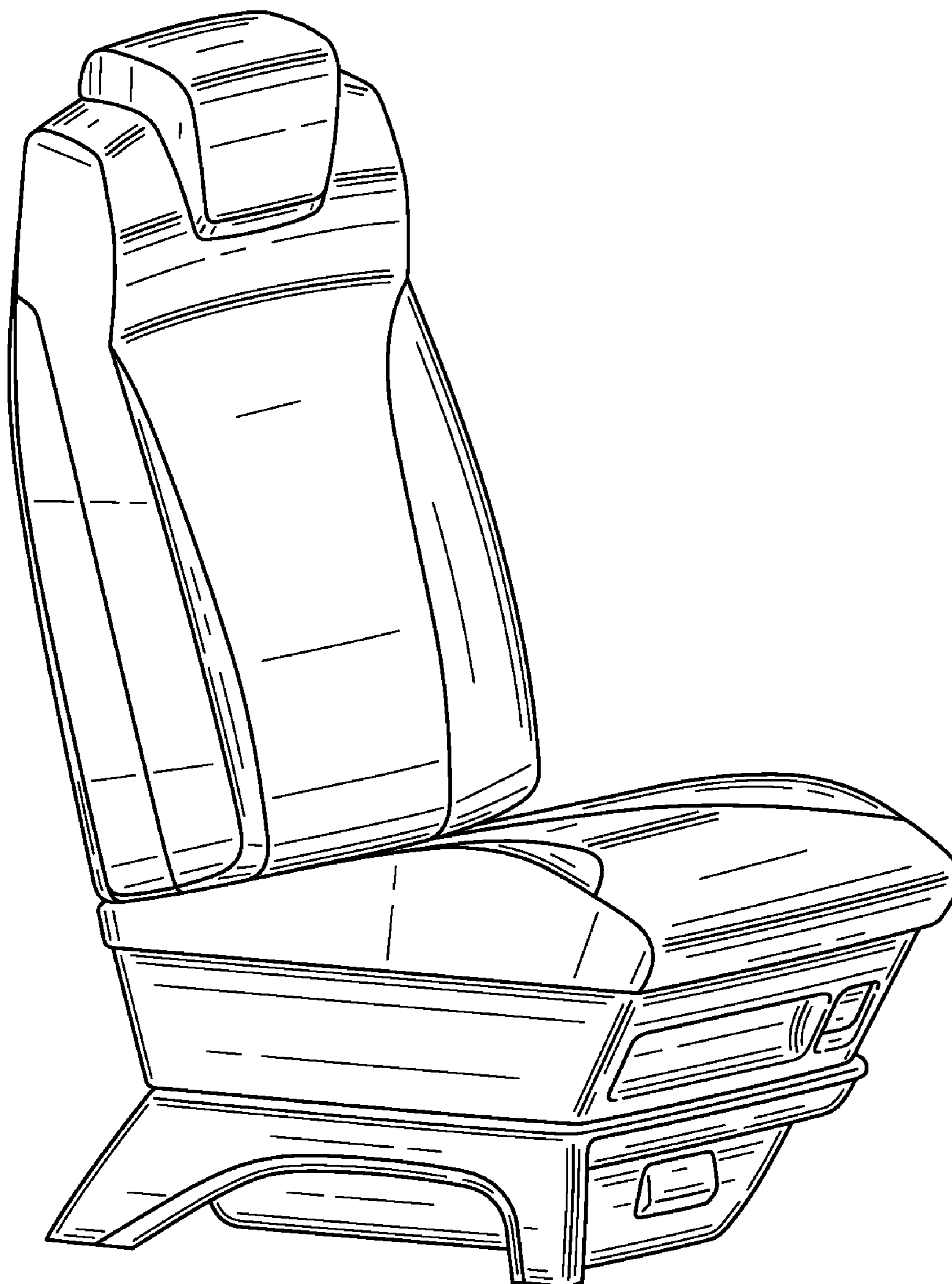

FIG. 1

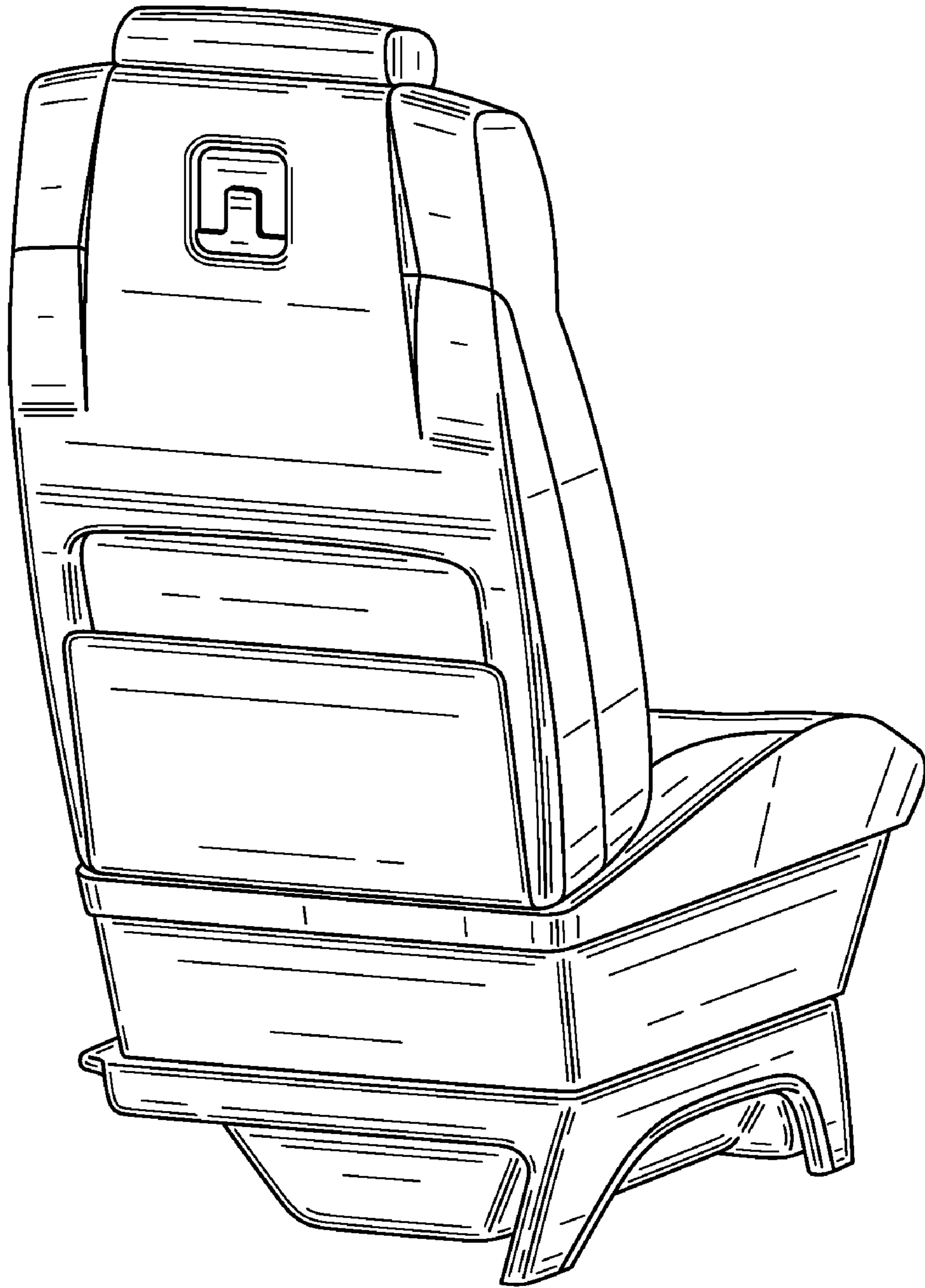

FIG. 2

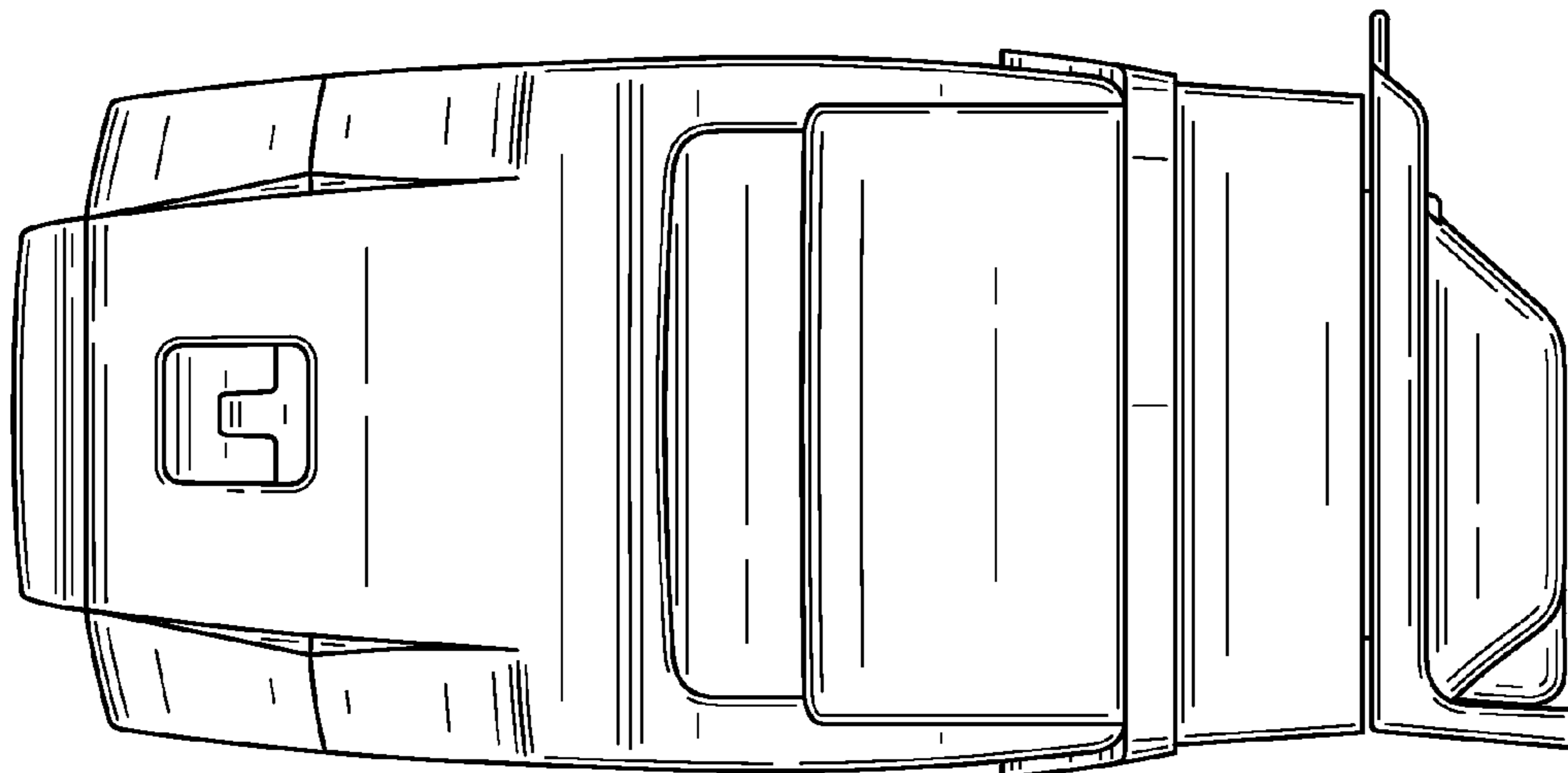

FIG. 4

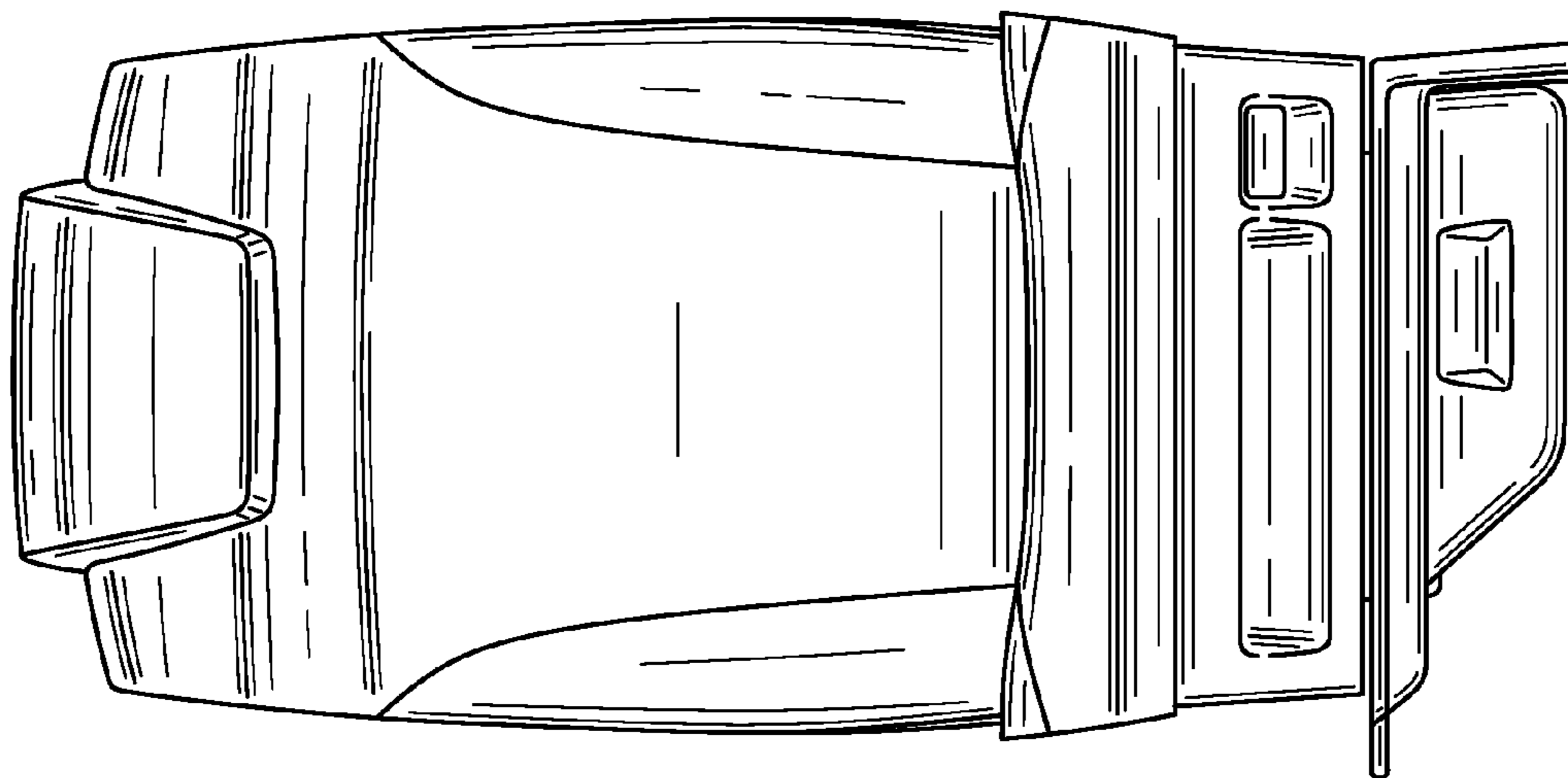

FIG. 3

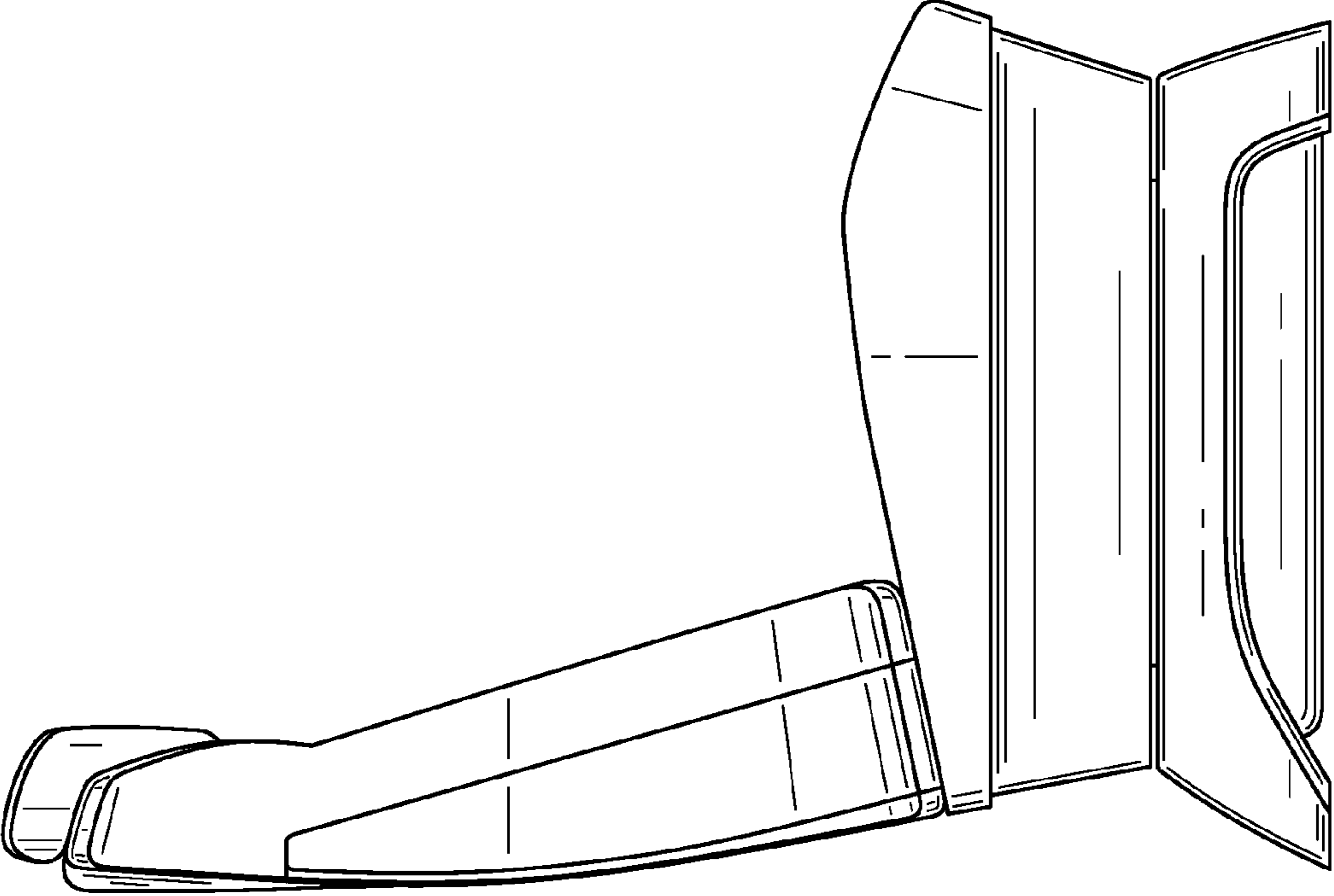

FIG. 6

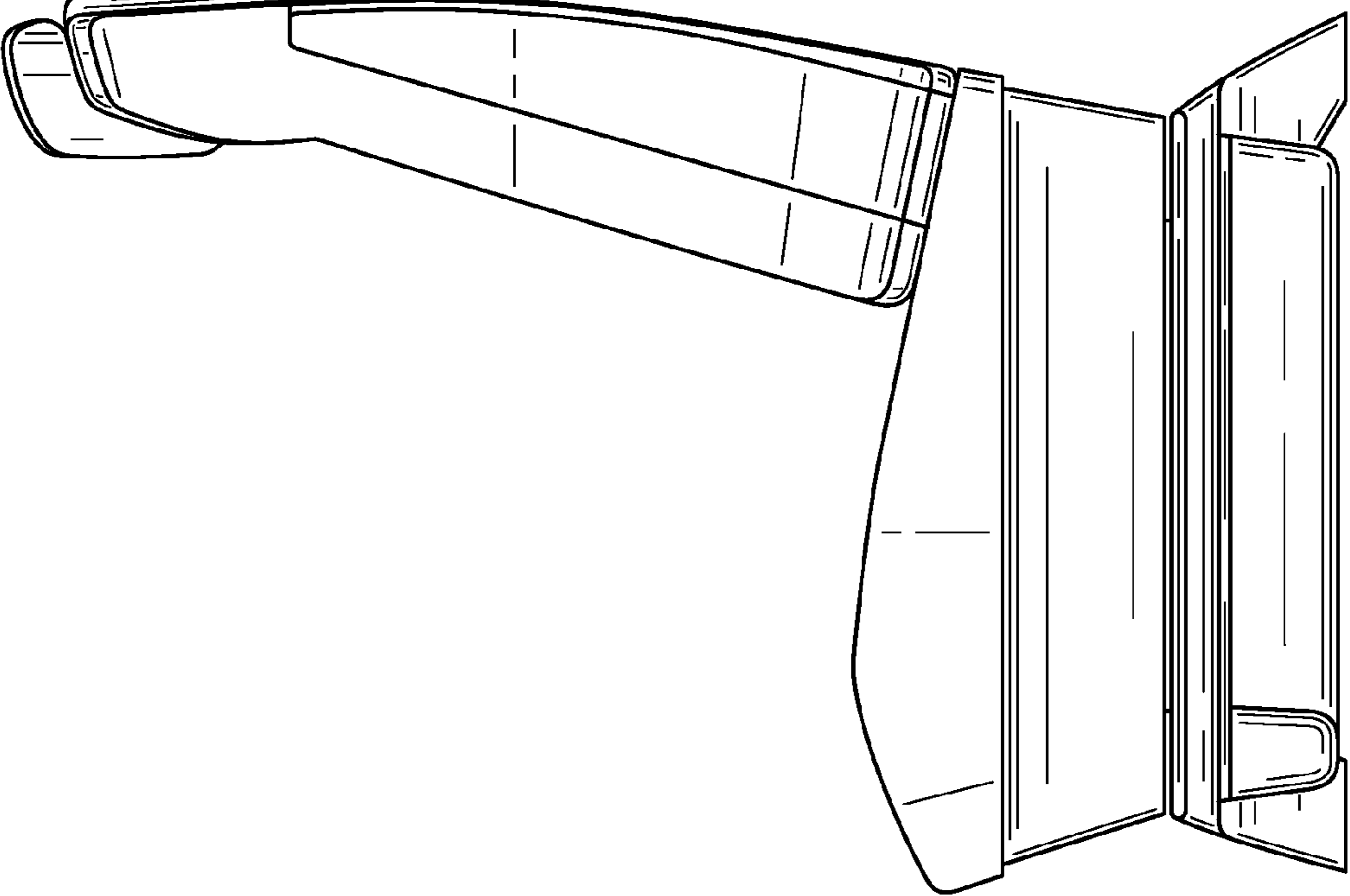

FIG. 5

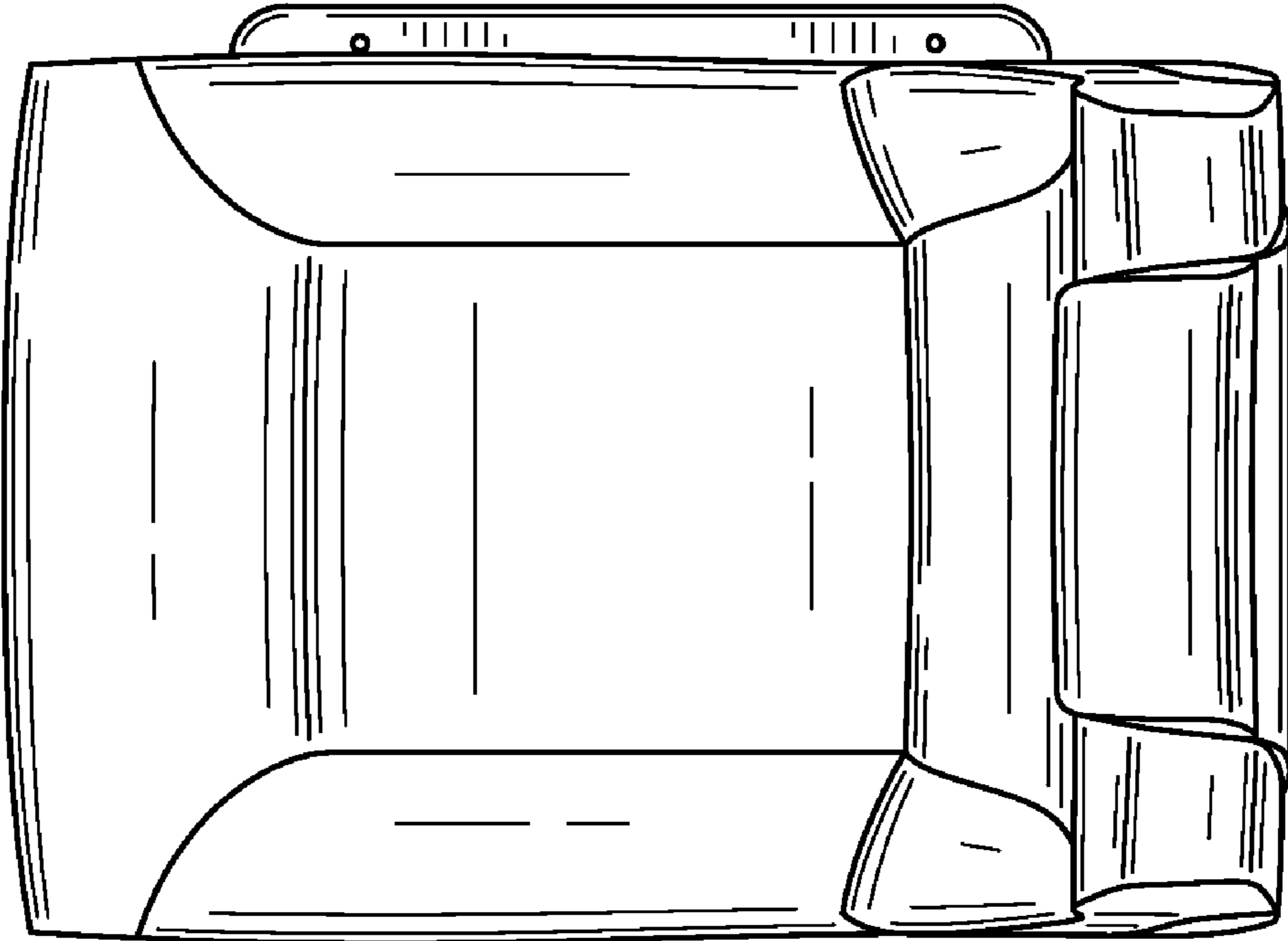

FIG. 7