

US00D577474S

(12) **United States Design Patent**
Siminski

(10) **Patent No.:** **US D577,474 S**

(45) **Date of Patent:** **** Sep. 23, 2008**

(54) **GOLF CLUB ICE SCRAPER**

D522,756 S * 6/2006 Moore D4/124
7,077,757 B1 * 7/2006 Payne et al. 473/238

(76) Inventor: **Robert M. Siminski**, 4514 Villa Rio,
Independence Township, MI (US) 48348

* cited by examiner

(**) Term: **14 Years**

Primary Examiner—Pamela J. Burgess

(21) Appl. No.: **29/295,716**

(57) **CLAIM**

(22) Filed: **Oct. 4, 2007**

The ornamental design for a golf club ice scraper, as shown and described.

(51) **LOC (8) Cl.** **07-05**

(52) **U.S. Cl.** **D32/43**

(58) **Field of Classification Search** D32/40,
D32/43, 45-49; 15/236.01-236.06, 111;
30/169, 172; D21/759

See application file for complete search history.

DESCRIPTION

FIG. 1 is a perspective view of a golf club ice scraper showing my new design;

FIG. 2 is a top plan view thereof;

FIG. 3 is a side elevational view thereof;

FIG. 4 is a front end elevational view thereof;

FIG. 5 is a side elevational view thereof, opposite of FIG. 3;

FIG. 6 is a bottom plan view thereof; and,

FIG. 7 is a rear end view thereof.

(56) **References Cited**

U.S. PATENT DOCUMENTS

4,042,037	A *	8/1977	Whiteley	172/13
4,237,572	A *	12/1980	Larson	15/105
D453,248	S *	1/2002	Wachler et al.	D32/43
D453,250	S *	1/2002	Kleinpell	D32/43
D470,203	S *	2/2003	Rollinson et al.	D21/733

1 Claim, 4 Drawing Sheets

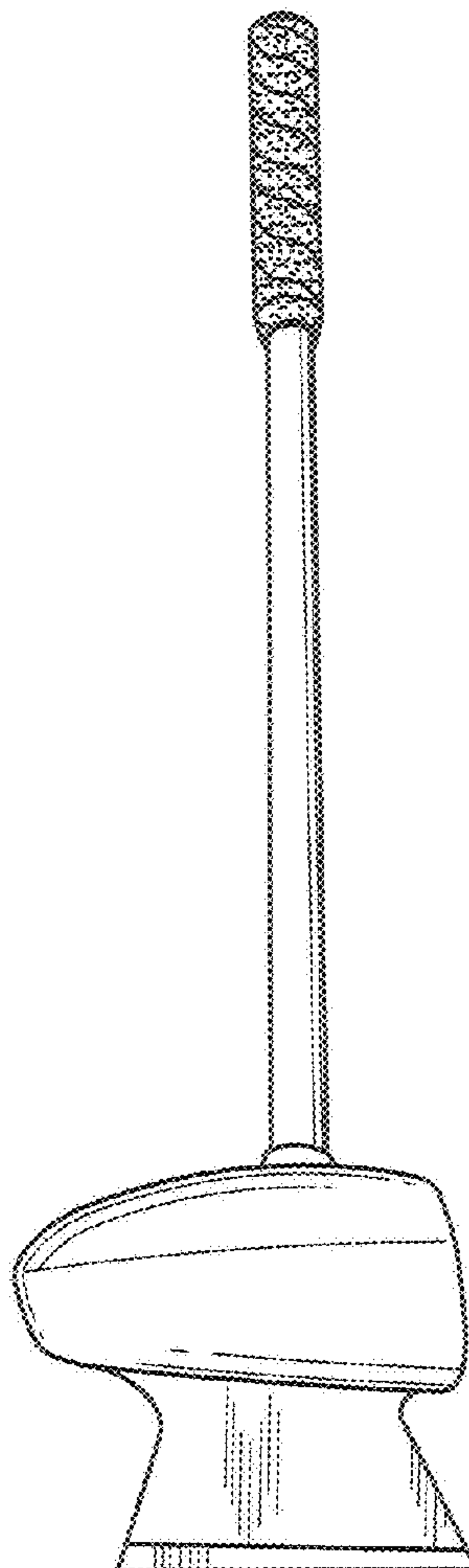

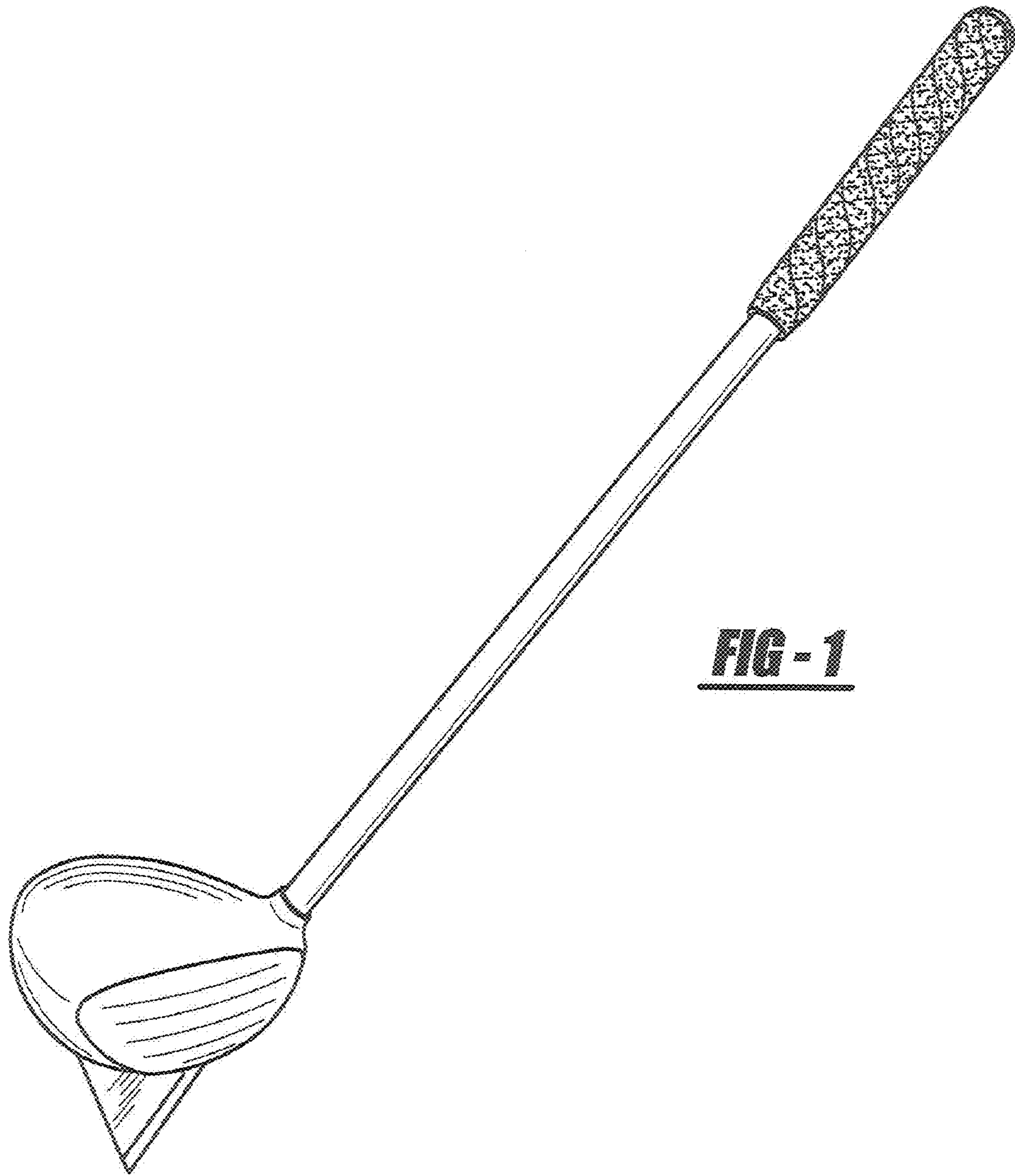

FIG - 1

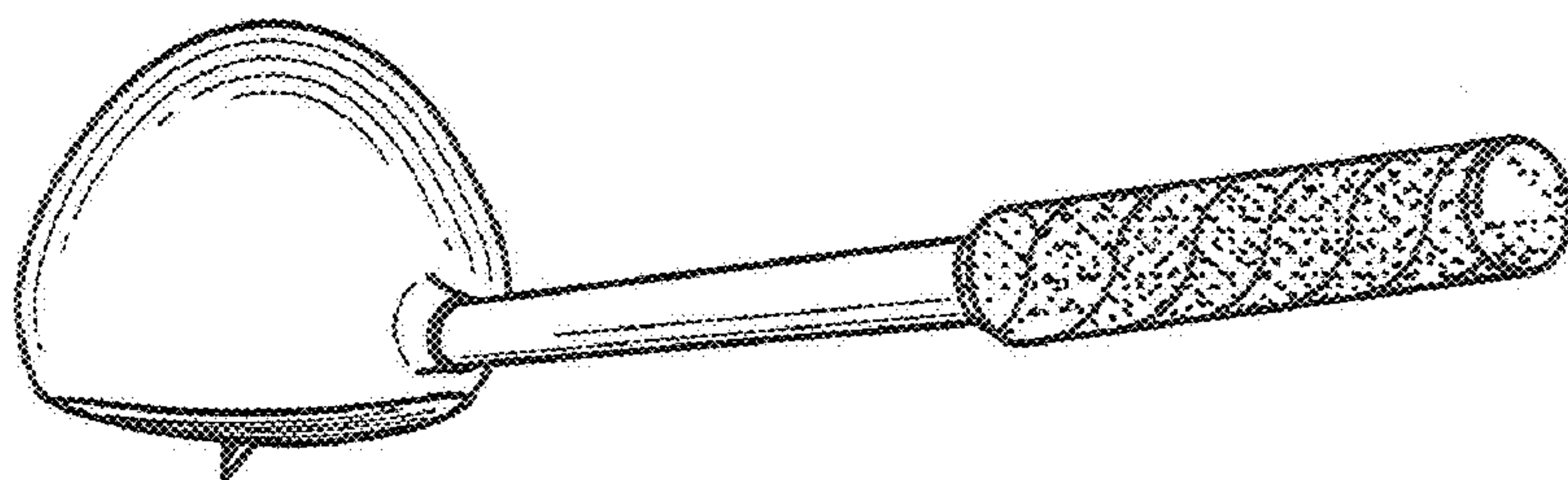

FIG - 2

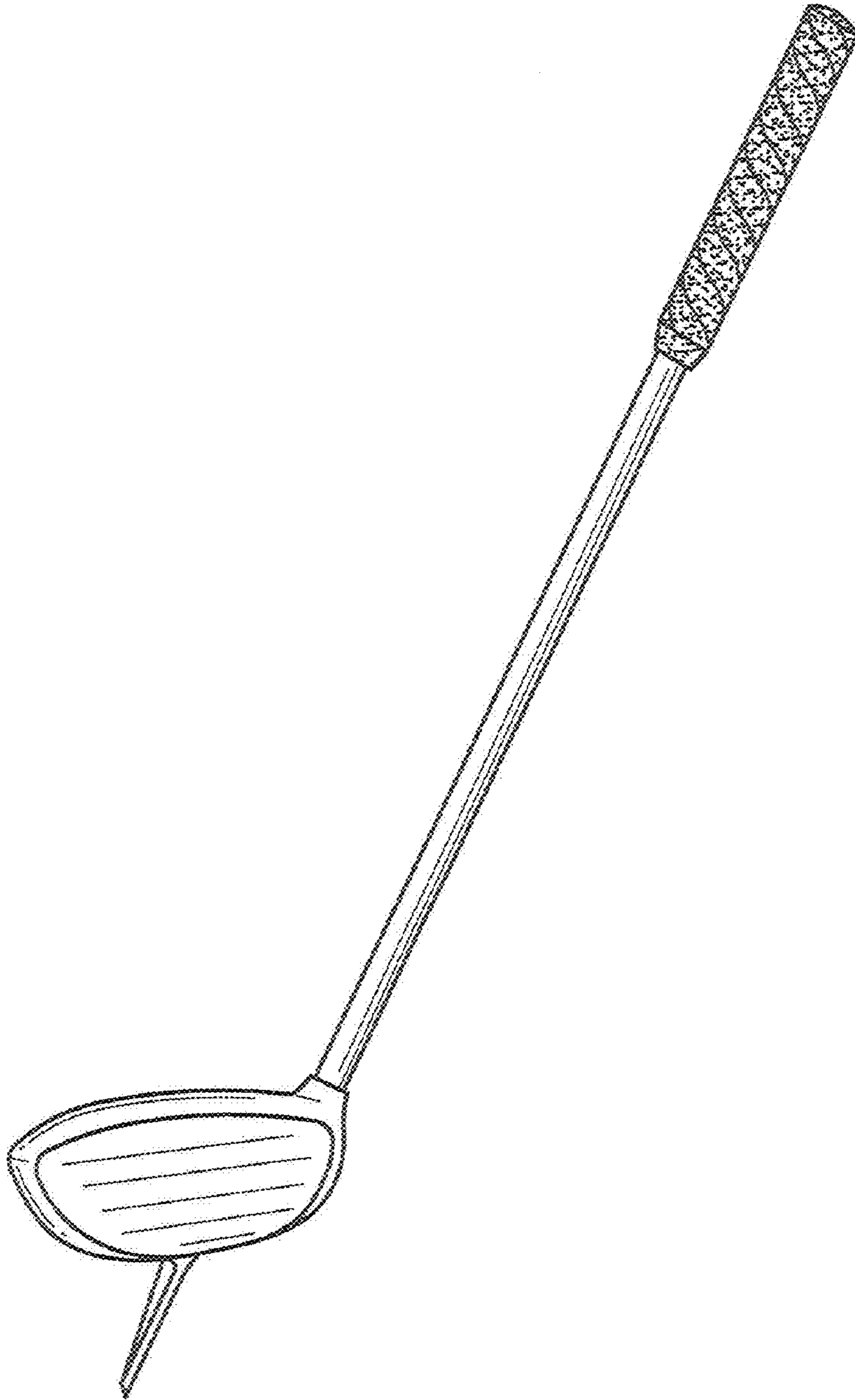

FIG - 3

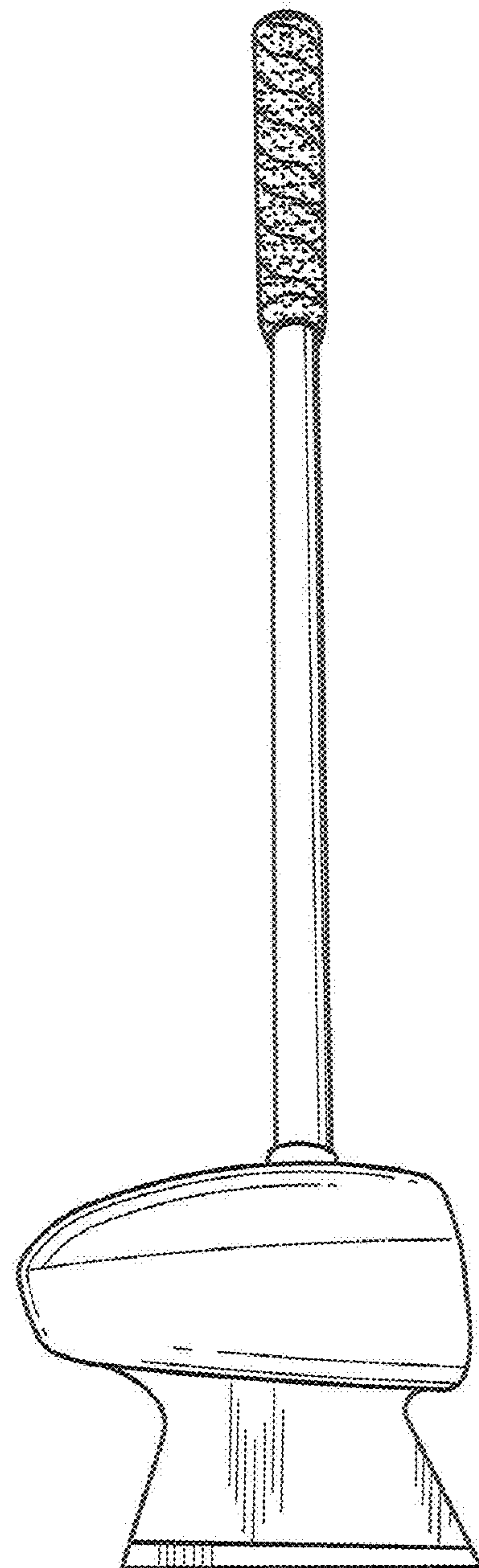

FIG - 4

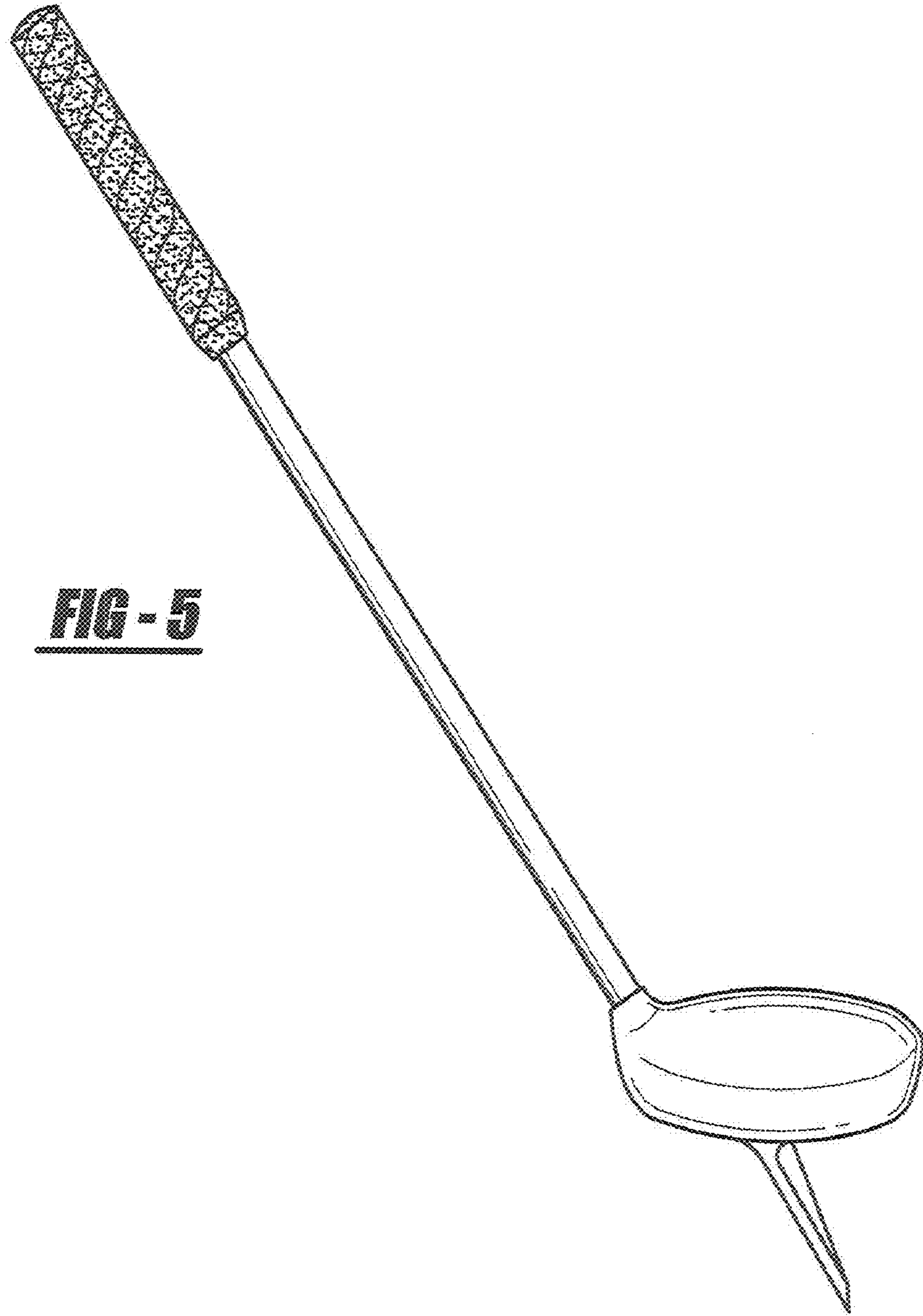

FIG - 5

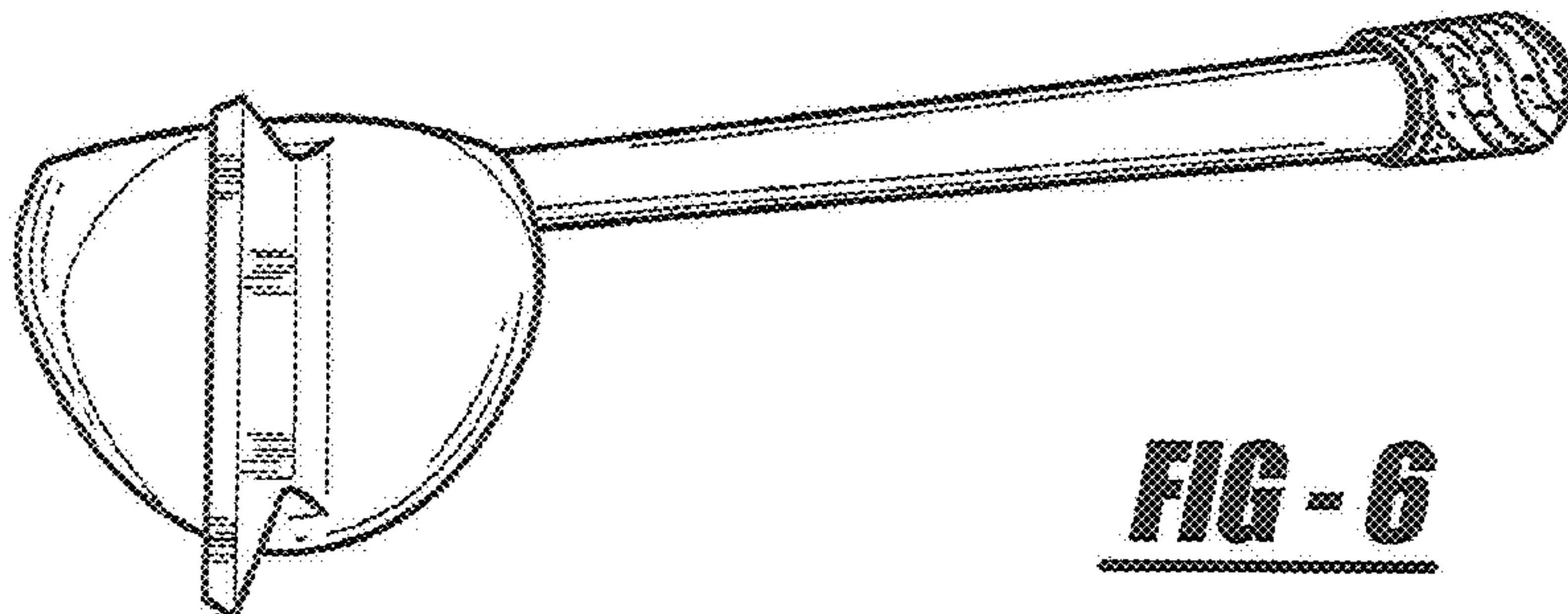

FIG - 6

FIG - 7

