



US00D577422S

(12) **United States Design Patent**  
**Williams**

(10) **Patent No.:** **US D577,422 S**  
(45) **Date of Patent:** **\*\* Sep. 23, 2008**

(54) **FAUCET**

D569,486 S \* 5/2008 Fritz et al. .... D23/241

(75) Inventor: **Emilie Williams**, Chicago, IL (US)

\* cited by examiner

(73) Assignee: **Masco Corporation of Indiana**,  
Indianapolis, IN (US)

*Primary Examiner*—Loius Zarfaz

*Assistant Examiner*—Mark Cavanna

(\*\*) Term: **14 Years**

(74) *Attorney, Agent, or Firm*—Leon E. Redman; Lloyd D. Doigan

(21) Appl. No.: **29/303,490**

(57) **CLAIM**

(22) Filed: **Feb. 11, 2008**

The ornamental design for a faucet, as shown and described.

(51) **LOC (8) Cl.** ..... **23-01**

(52) **U.S. Cl.** ..... **D23/241**

(58) **Field of Classification Search** ..... D23/200,  
D23/235, 238–257; D6/512, 546, 550; D8/300,  
D8/307–308, 310–312, 321; 4/675–678;  
137/801; 16/110.1, 441

See application file for complete search history.

**DESCRIPTION**

FIG. 1 is a front perspective view of a faucet showing my design;

FIG. 2 is a front elevational view thereof;

FIG. 3 is a rear elevational view thereof;

FIG. 4 is a right side elevational view thereof;

FIG. 5 is a left side elevational view thereof; and,

FIG. 6 is a top plan view thereof.

The broken lines in the Figures are for illustrative purposes only and form no part of the claimed design.

(56) **References Cited**

U.S. PATENT DOCUMENTS

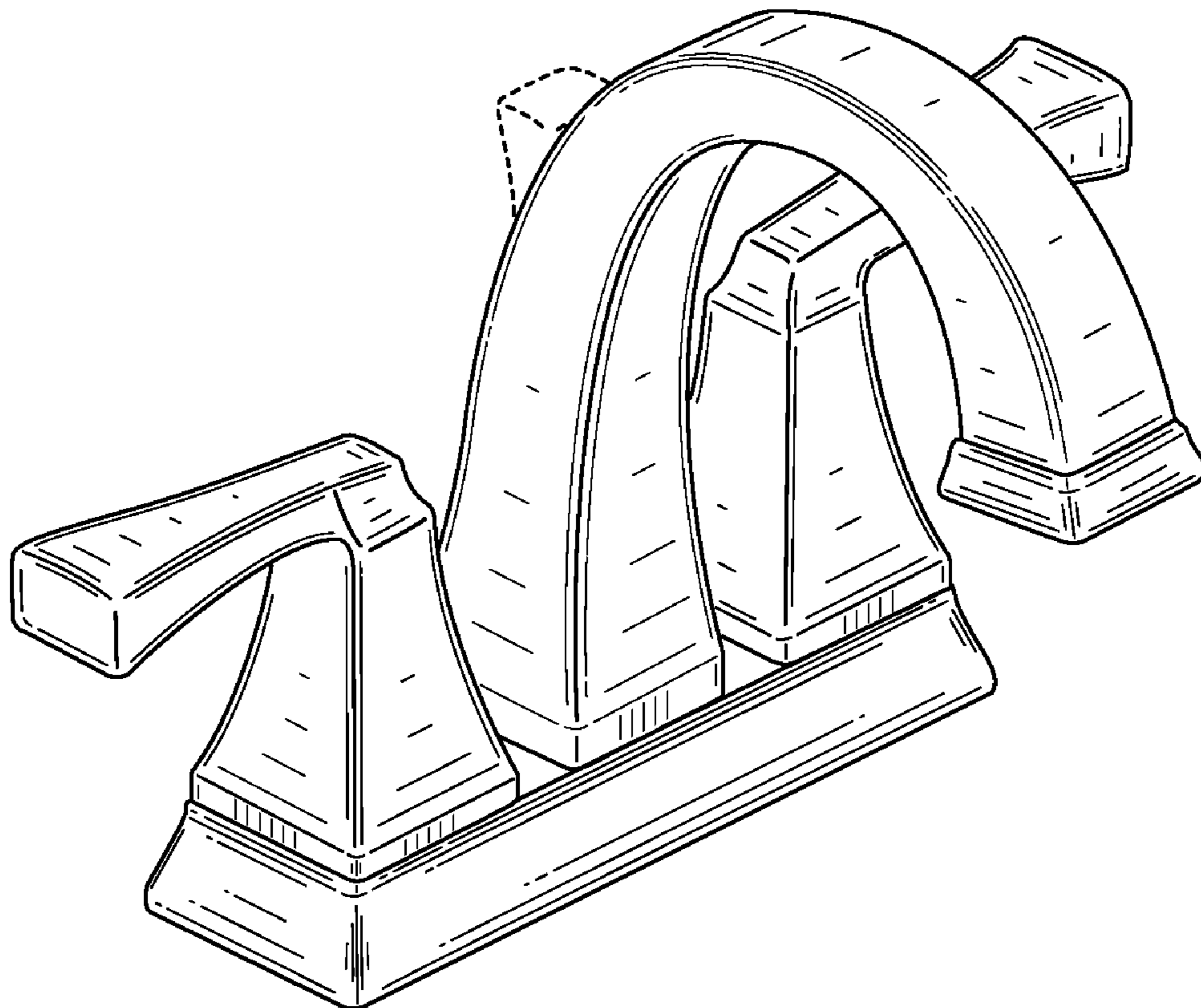
D511,371 S \* 11/2005 Chen ..... D23/242

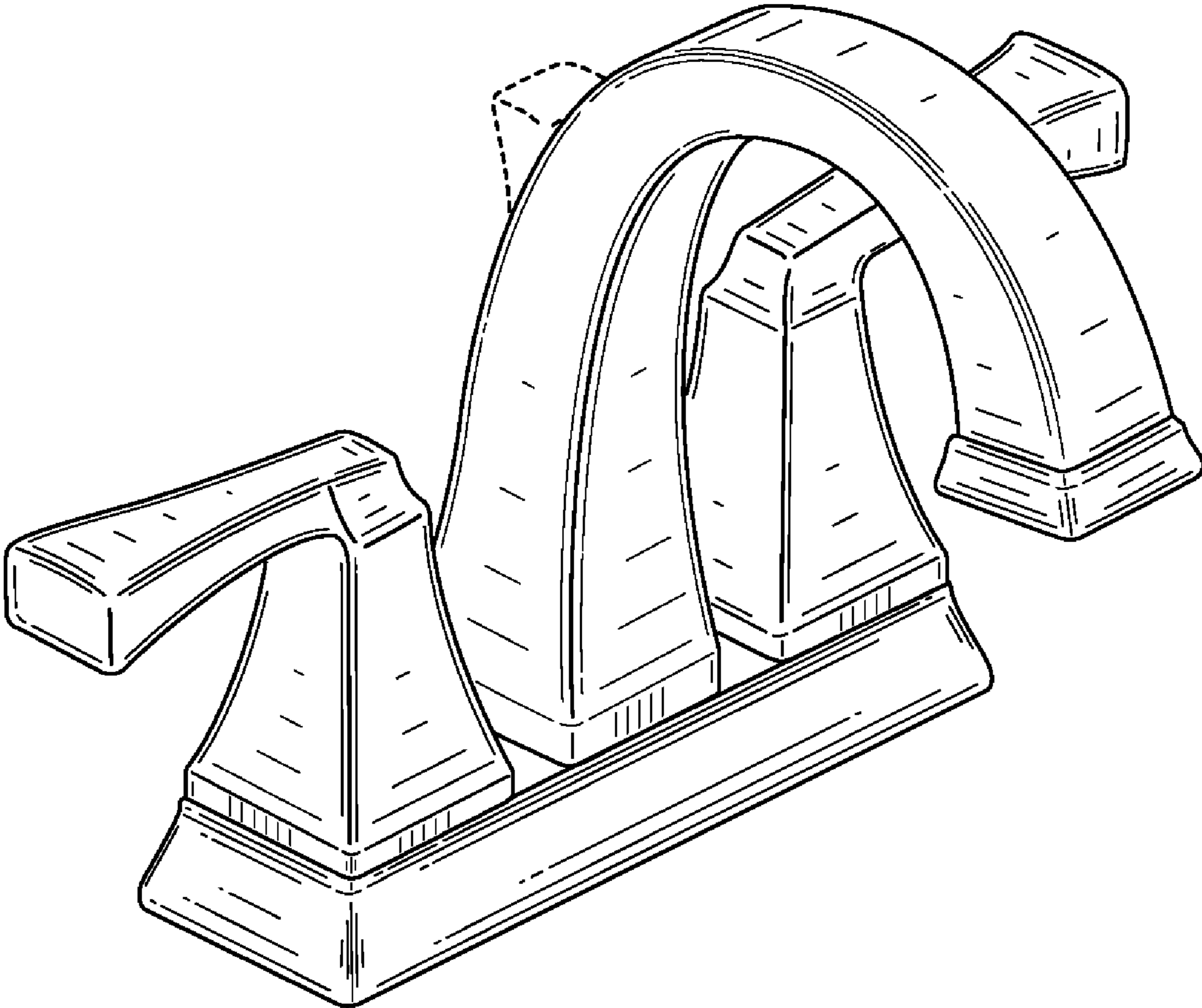
D520,116 S \* 5/2006 Koury et al. .... D23/241

D529,137 S \* 9/2006 Chu et al. .... D23/241

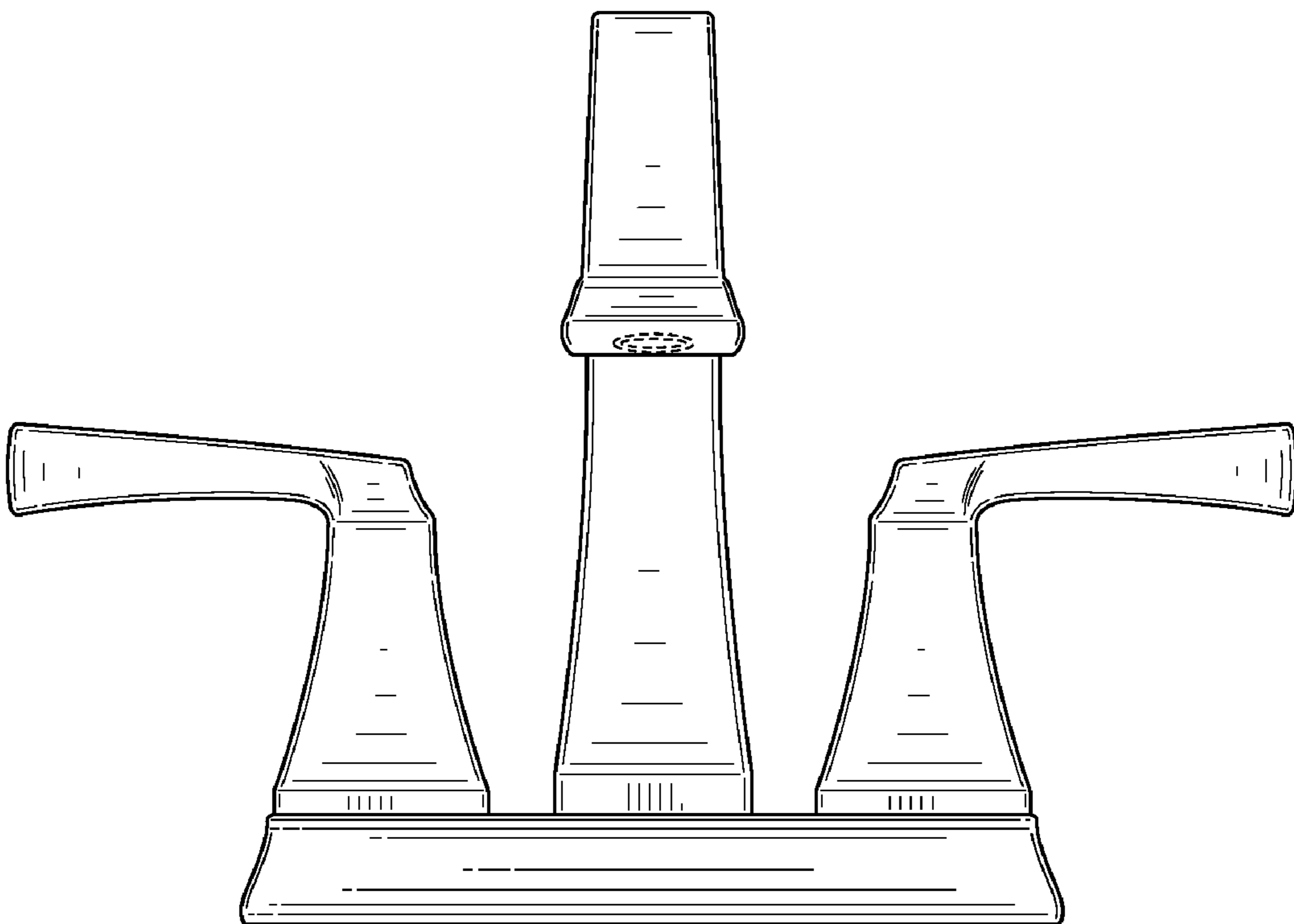
D566,814 S \* 4/2008 Yang ..... D23/241

**1 Claim, 6 Drawing Sheets**

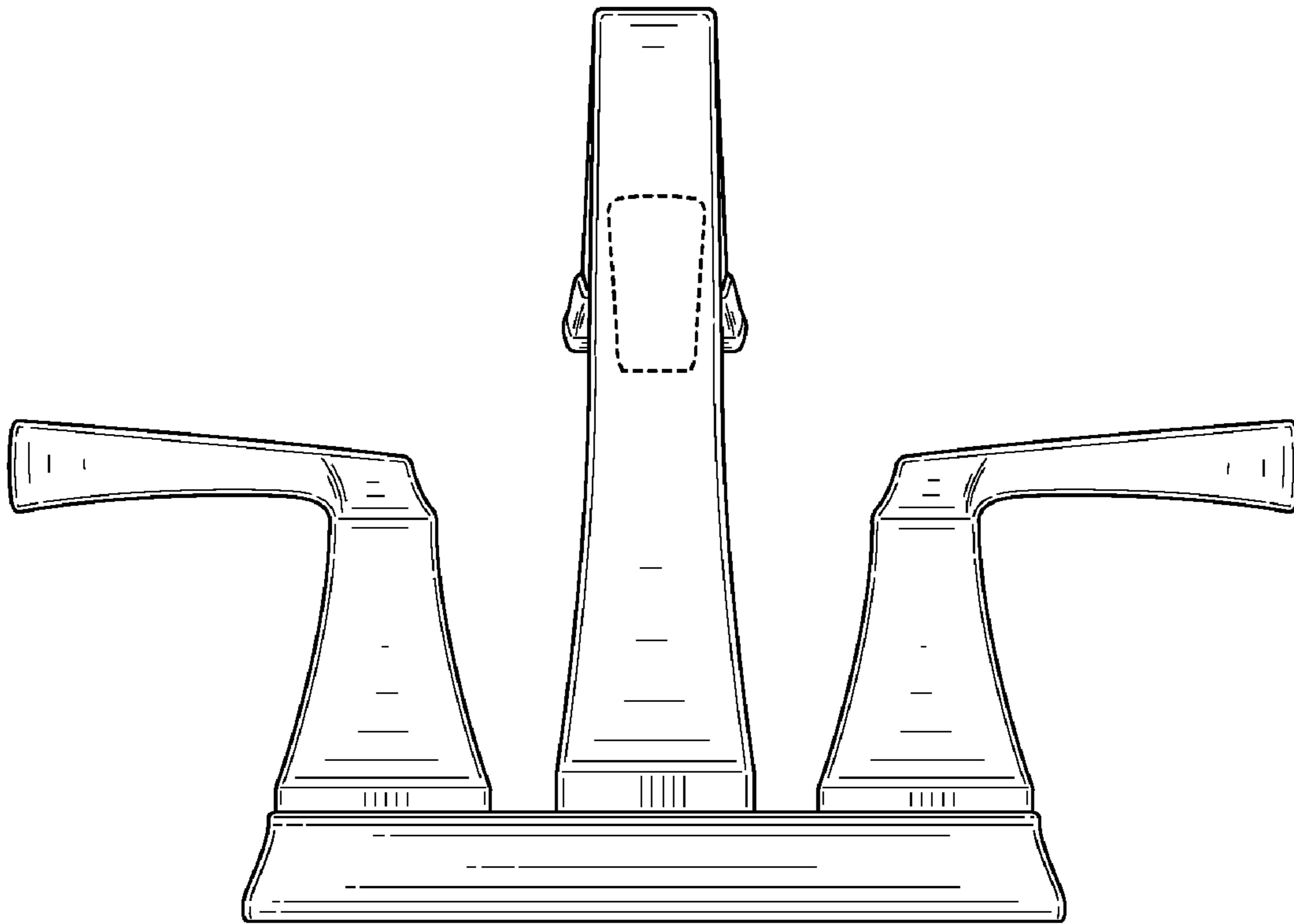




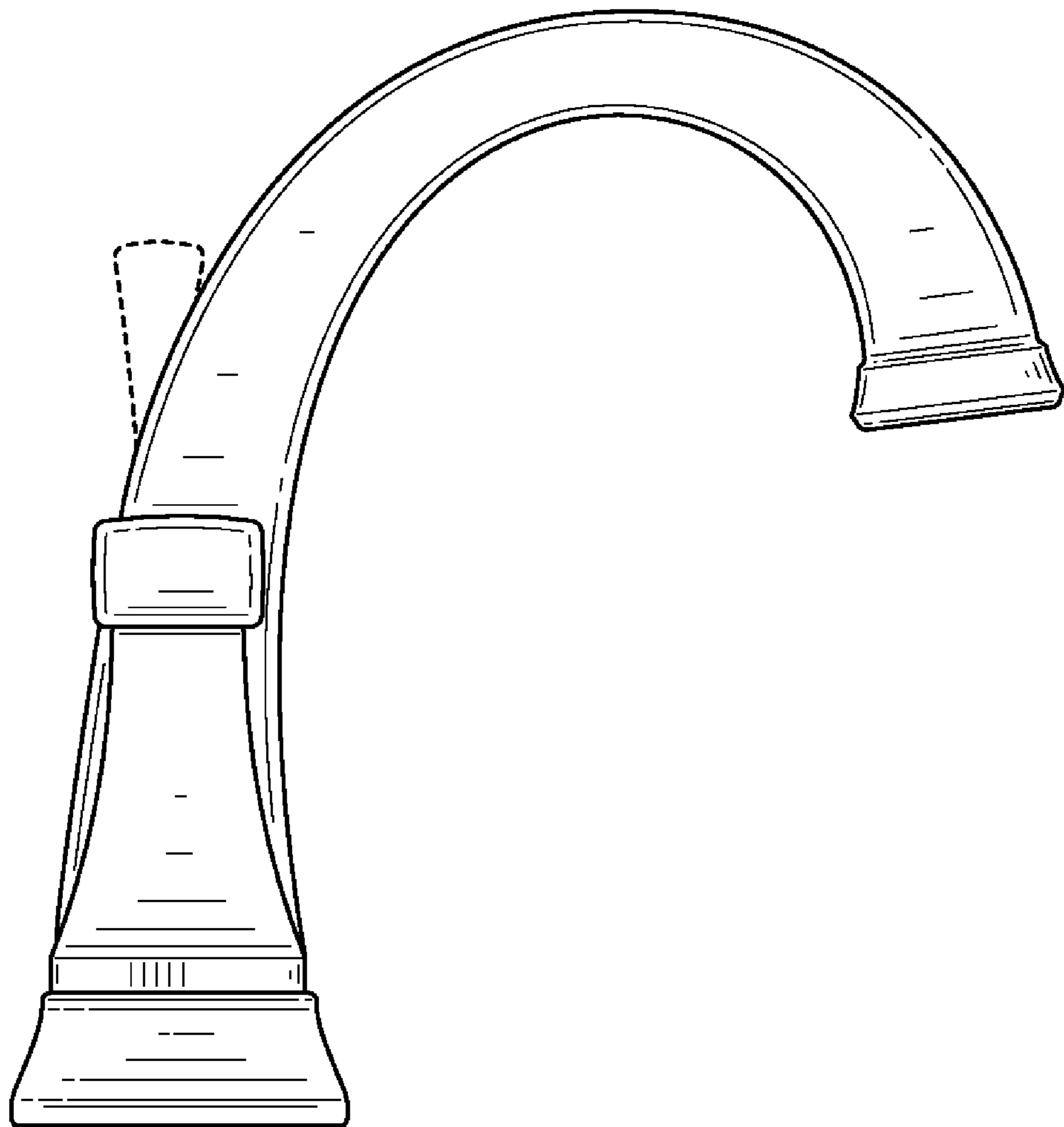
**FIG. 1**



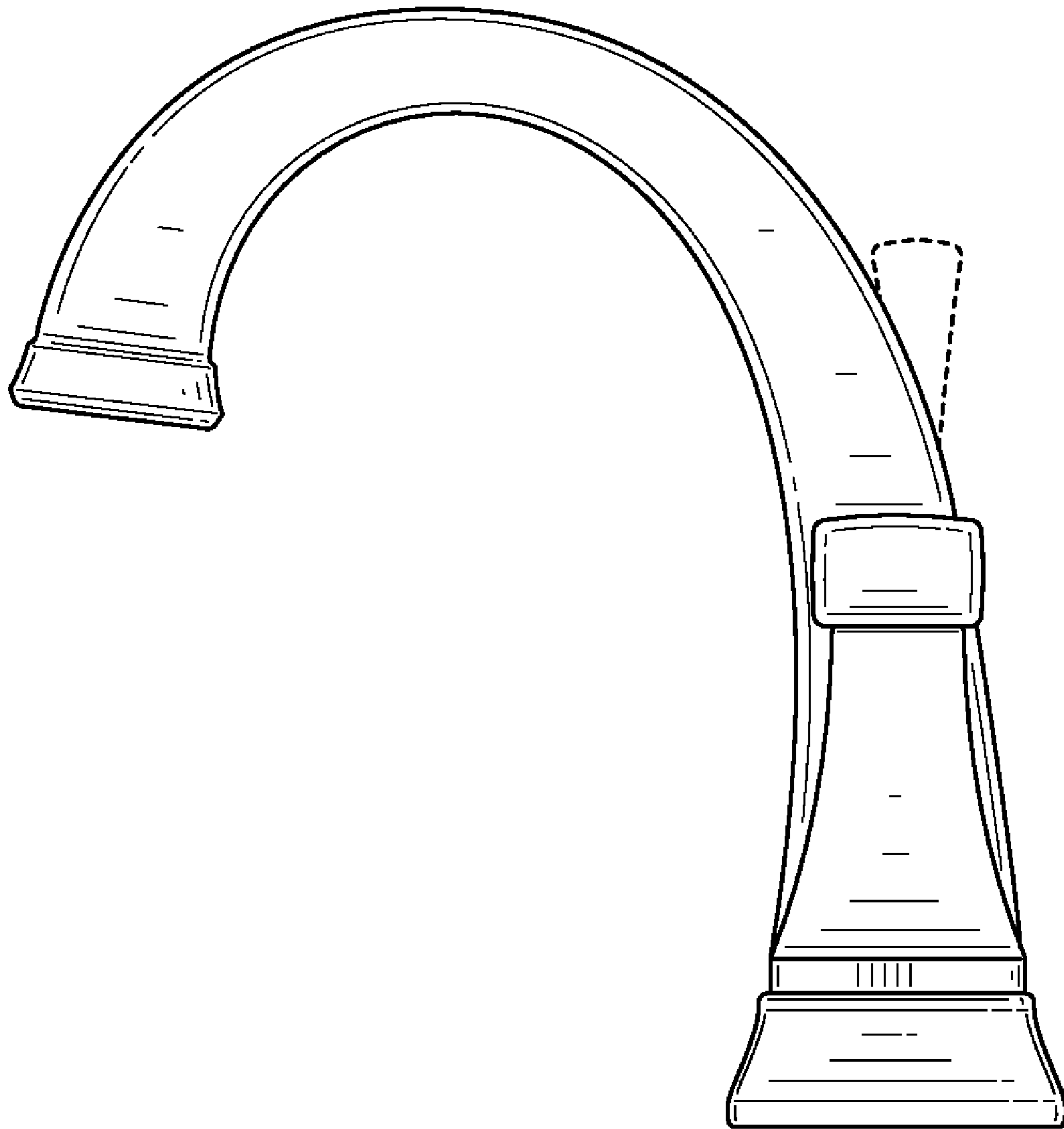
**FIG. 2**



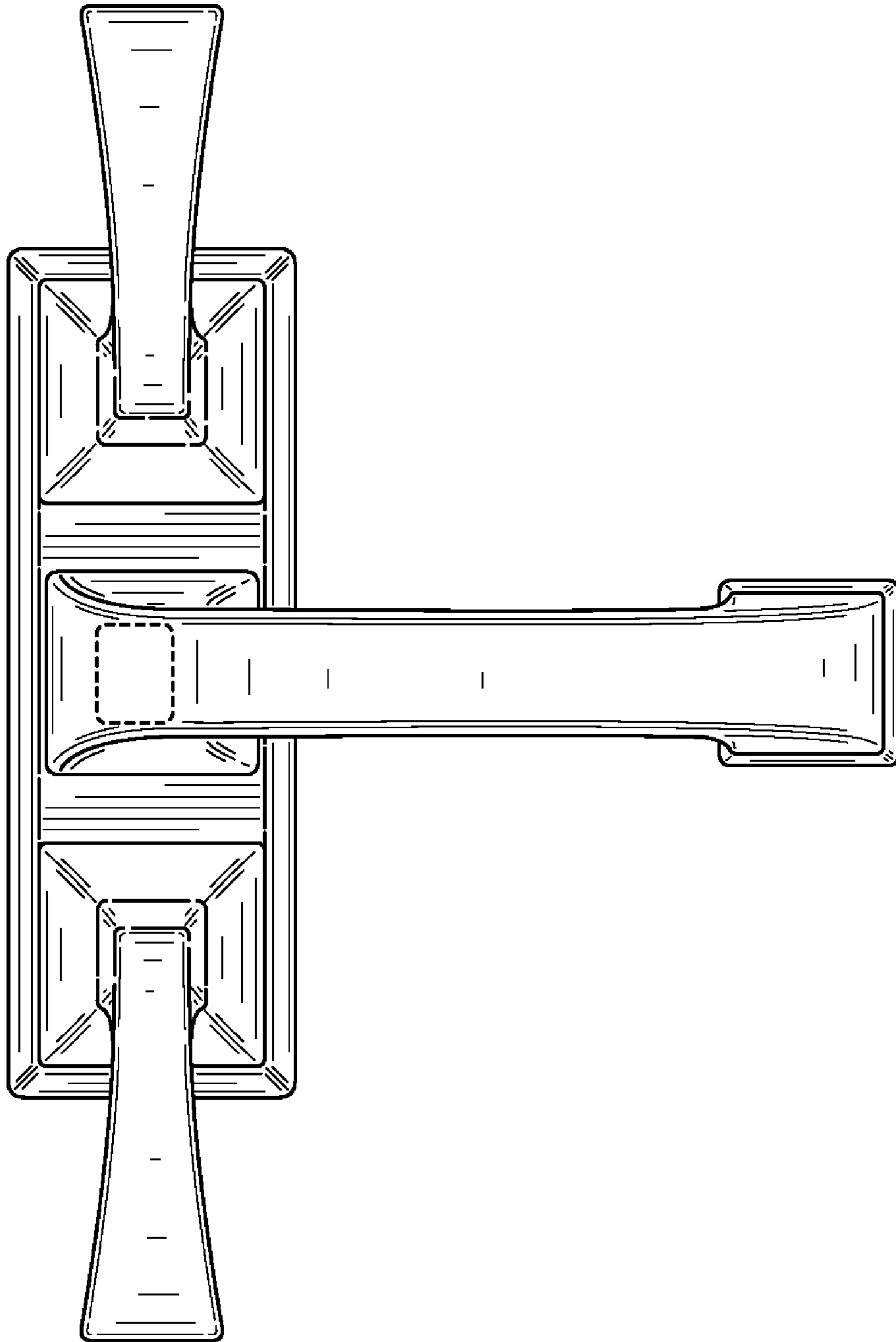
**FIG. 3**



**FIG. 4**



**FIG. 5**



**FIG. 6**