



US00D577350S

(12) **United States Design Patent**
Bang et al.

(10) **Patent No.:** **US D577,350 S**

(45) **Date of Patent:** **** Sep. 23, 2008**

(54) **MOBILE PHONE**

(75) Inventors: **Yong-Seok Bang**, Seoul (KR);
Sang-Min Hyun, Seoul (KR);
Chang-Hwan Hwang, Goyang-si (KR)

(73) Assignee: **Samsung Electronics Co., Ltd.**,
Suwon-Si (KR)

(**) Term: **14 Years**

(21) Appl. No.: **29/290,097**

(22) Filed: **Oct. 19, 2007**

(30) **Foreign Application Priority Data**

Aug. 10, 2007 (KR) 30-2007-0034494

(51) **LOC (8) Cl.** **14-03**

(52) **U.S. Cl.** **D14/138**

(58) **Field of Classification Search** D14/137,
D14/138, 147, 191, 218, 247-248, 341-347,
D14/496; D10/65, 78, 104; D13/168; D18/7;
455/556.1, 575.1, 575.3, 575.4; 345/169
See application file for complete search history.

(56) **References Cited**

U.S. PATENT DOCUMENTS

D371,387	S	*	7/1996	Woock	D19/20
7,016,182	B2	*	3/2006	Brandenberg et al.	361/683
D532,791	S	*	11/2006	Kim	D14/496
D536,329	S	*	2/2007	Lee	D14/156
D540,203	S	*	4/2007	Jeon	D10/65
D541,785	S	*	5/2007	Hwang et al.	D14/138
D548,713	S	*	8/2007	Lee et al.	D14/138
D554,098	S	*	10/2007	Lee	D14/138
D554,099	S	*	10/2007	Kim et al.	D14/138
D555,134	S	*	11/2007	Sung et al.	D14/138
D556,211	S	*	11/2007	Howard et al.	D14/496
D558,460	S	*	1/2008	Yu et al.	D6/308
D558,720	S	*	1/2008	Lee et al.	D14/138

D558,757	S	*	1/2008	Andre et al.	D14/341
D559,220	S	*	1/2008	Lee et al.	D14/138
D560,192	S	*	1/2008	Lee et al.	D14/138
D560,194	S	*	1/2008	Song et al.	D14/138
D560,231	S	*	1/2008	Lee	D14/496
D562,292	S	*	2/2008	Park	D14/138
D563,938	S	*	3/2008	Kim et al.	D14/138
2006/0111158	A1	*	5/2006	Hou	455/575.1
2006/0148541	A1	*	7/2006	Vance	455/575.3
2007/0080950	A1	*	4/2007	Lee et al.	345/169
2007/0265031	A1	*	11/2007	Koizumi et al.	455/556.1
2007/0287512	A1	*	12/2007	Kilpi et al.	455/575.1
2008/0039151	A1	*	2/2008	Kim et al.	455/566

OTHER PUBLICATIONS

LG KF700, announced Feb. 2008, [online], [retrieved on Mar. 21, 2008]. Retrieved from Internet ,<URL: <http://www.gsmarena.com>>.*

* cited by examiner

Primary Examiner—Jeffrey D. Asch

Assistant Examiner—Bridget L Eland

(74) *Attorney, Agent, or Firm*—Staas & Halsey LLP

(57) **CLAIM**

The ornamental design for a mobile phone, as shown and described.

DESCRIPTION

FIG. 1 is a perspective view of a mobile phone;
FIG. 2 is a front view of the mobile phone of FIG. 1;
FIG. 3 is a rear view of the mobile phone of FIG. 1;
FIG. 4 is left-side of the mobile phone of FIG. 1;
FIG. 5 is right-side of the mobile phone of FIG. 1;
FIG. 6 is top plan view of the mobile phone of FIG. 1; and,
FIG. 7 is bottom plan view of the mobile phone of FIG. 1.

1 Claim, 4 Drawing Sheets

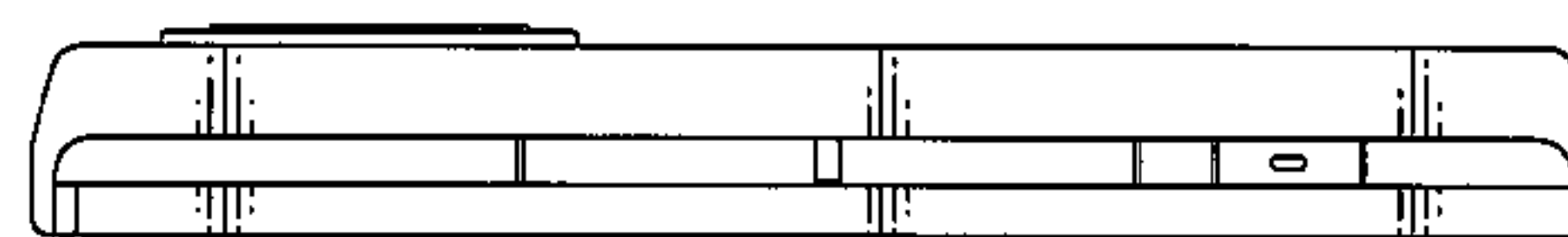
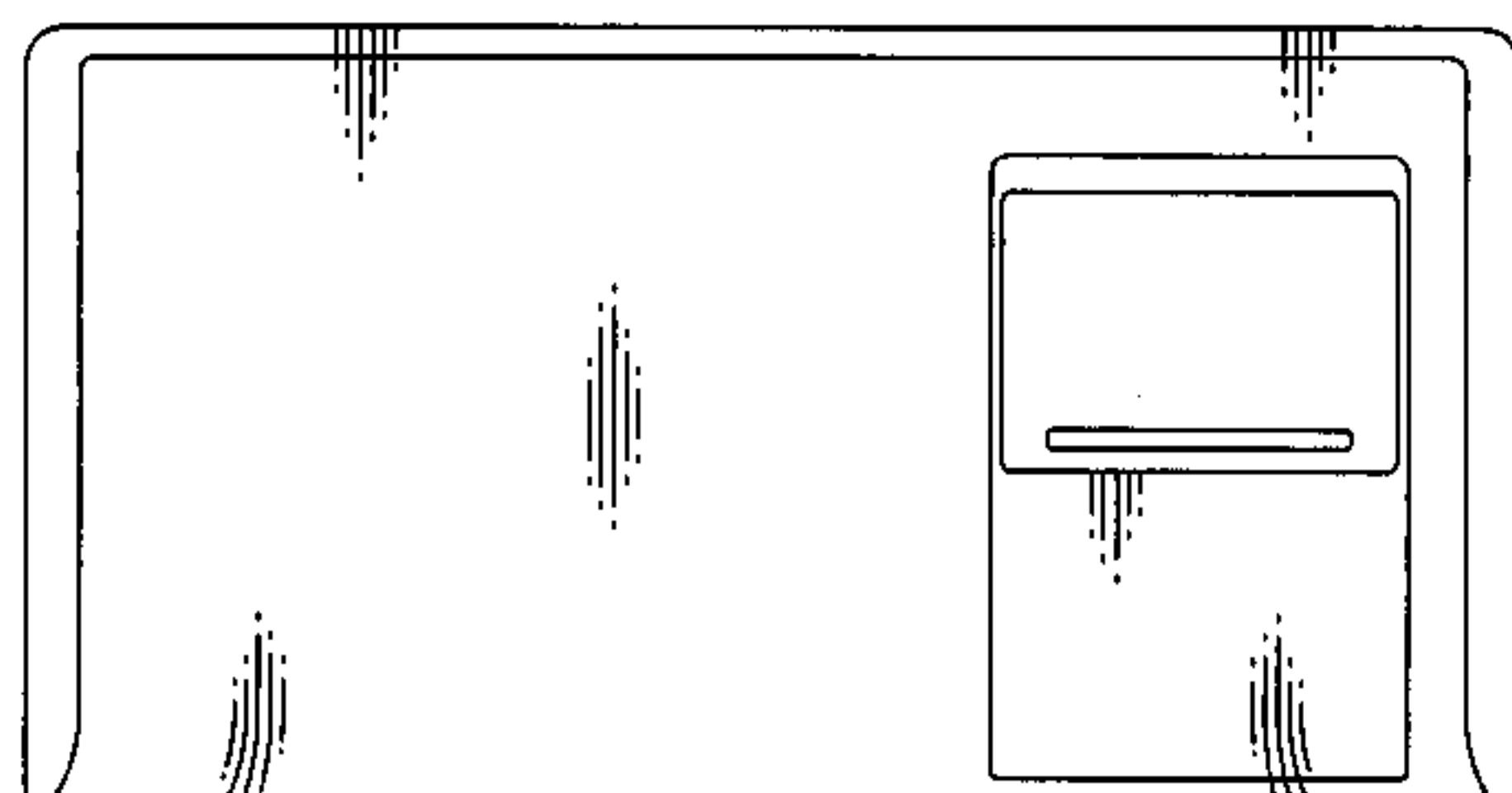
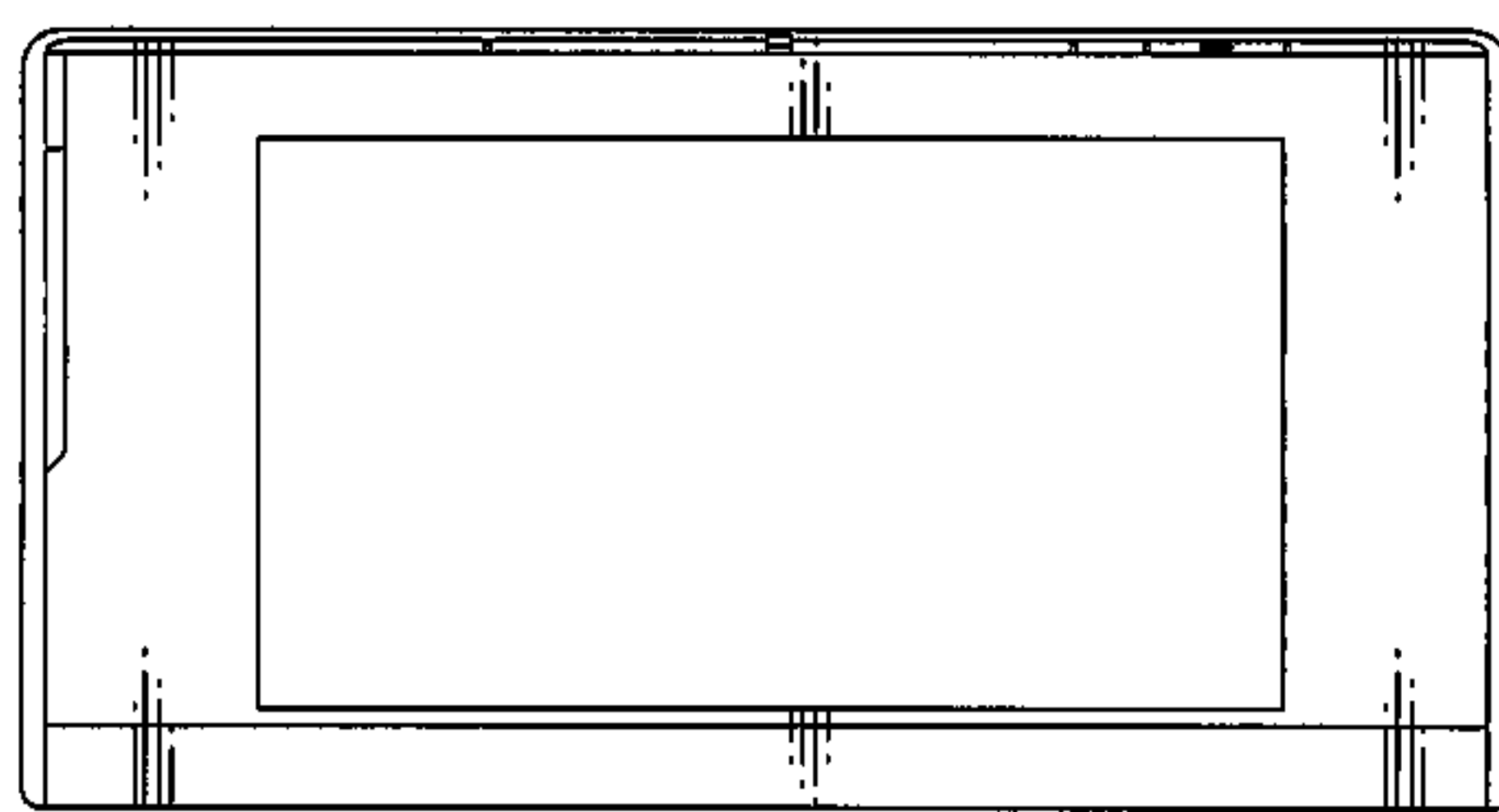

FIG. 1

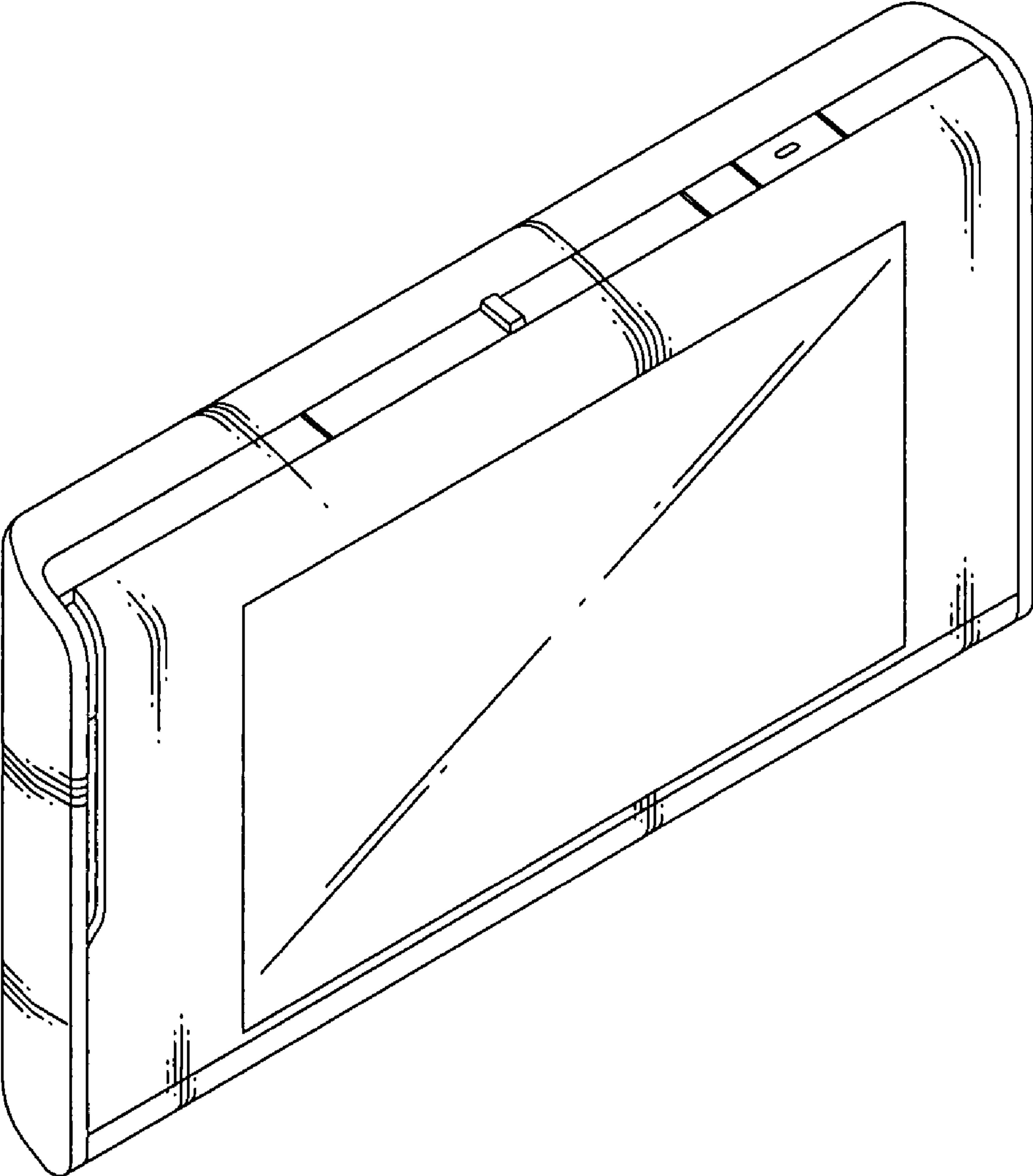

FIG. 2

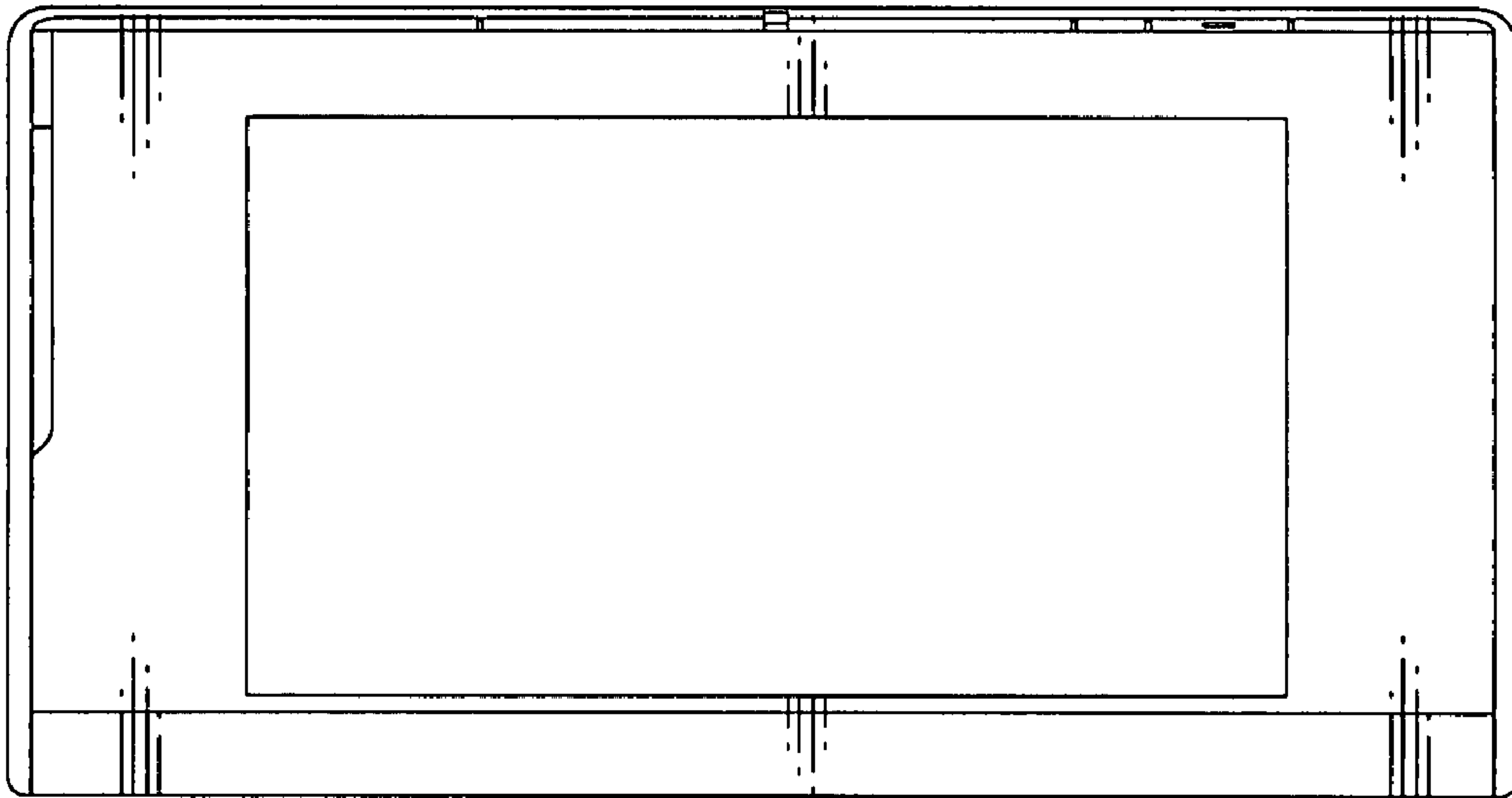

FIG. 3

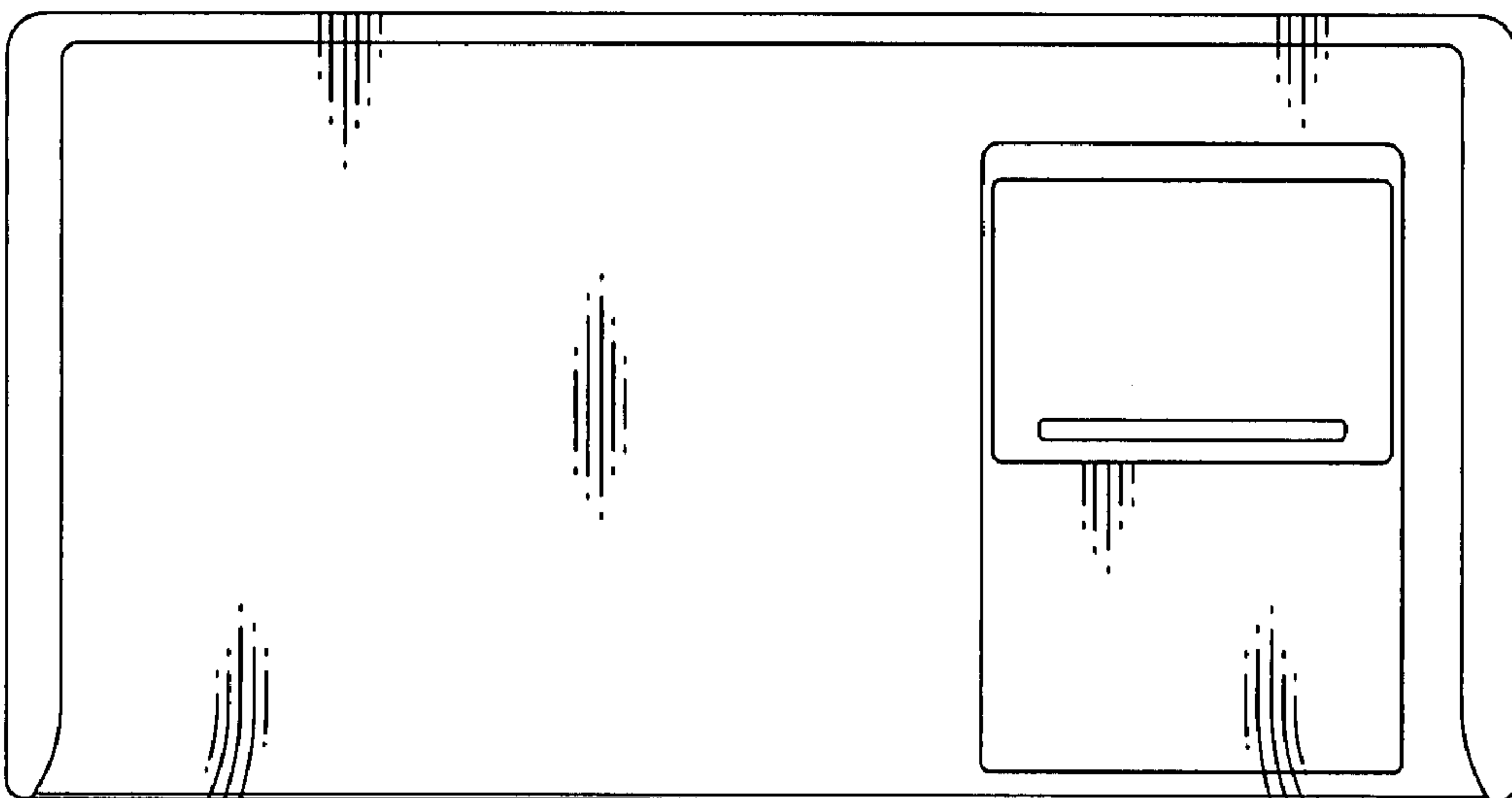

FIG. 4

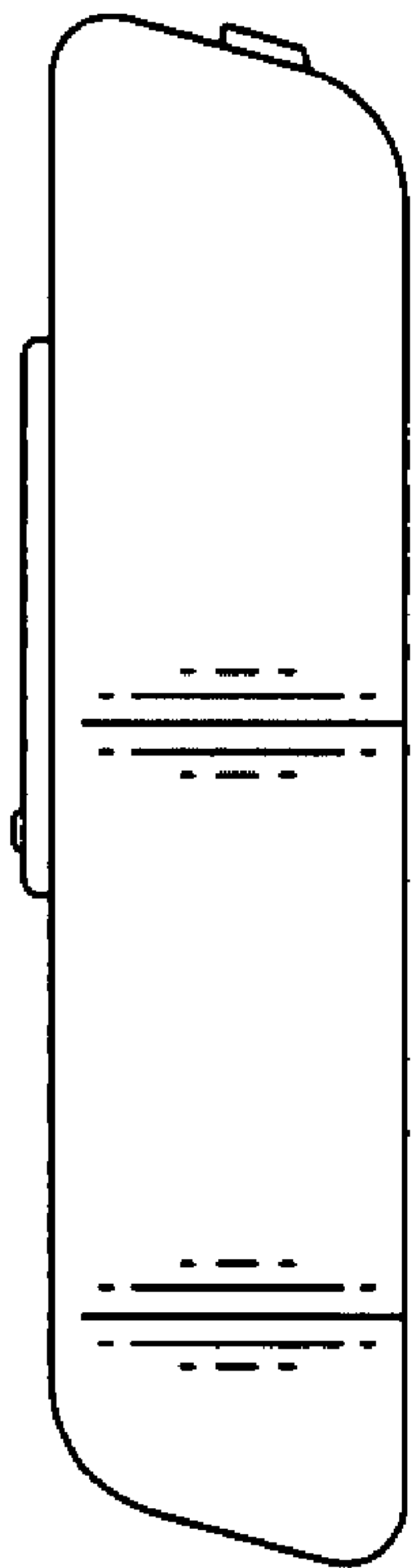

FIG. 5

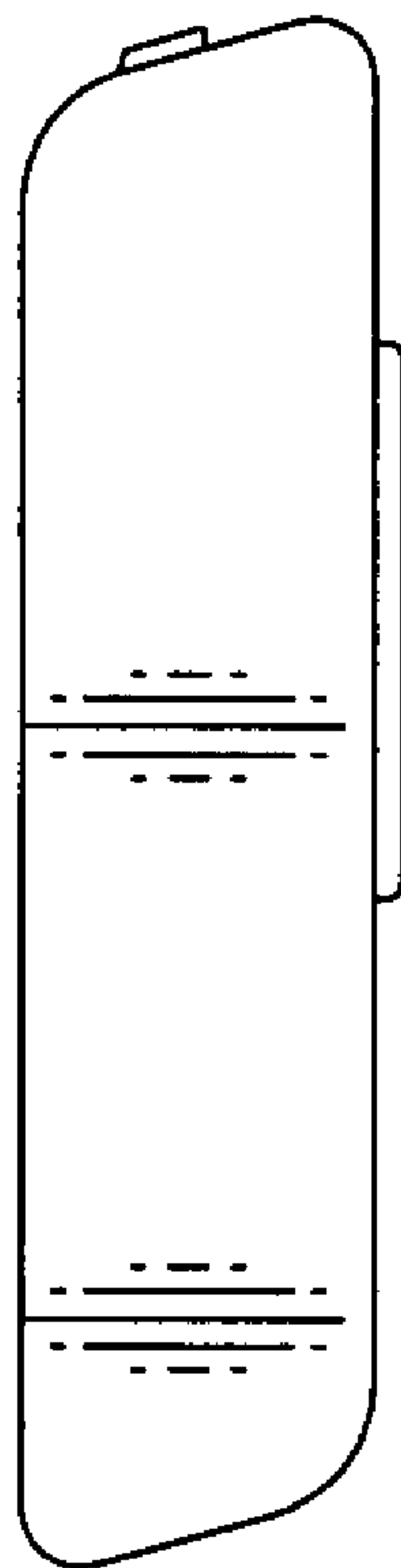

FIG. 6



FIG. 7

