



US00D577336S

(12) **United States Design Patent**
Kaser et al.

(10) **Patent No.:** **US D577,336 S**

(45) **Date of Patent:** **** Sep. 23, 2008**

(54) **MODULAR DECENTRAL ELECTRONIC MOTOR STARTER**

(75) Inventors: **Josef Kaser**, Ebermannsdorf (DE);
Norbert Reichenbach, Amberg (DE);
Bernhard Streich, Amberg (DE);
Michael Weigand, Roth (DE)

(73) Assignee: **Siemens Aktiengesellschaft**, Munich (DE)

(**) Term: **14 Years**

(21) Appl. No.: **29/273,066**

(22) Filed: **Feb. 26, 2007**

(51) **LOC (8) Cl.** **13-03**

(52) **U.S. Cl.** **D13/126; D13/113**

(58) **Field of Classification Search** D13/123-127,
D13/133, 154, 159, 113, 184, 199; 439/126-130,
439/500, 775, 135, 814, 289; 73/118.1, 116,
73/865.9, 117.2, 117.3; 123/146.5 R, 594,
123/595, 596, 599; 200/43.03, 293, 50.01-50.16,
200/280, 303, 333, 337, 294, 297; D15/5;
290/48; 310/89; 74/78

See application file for complete search history.

(56) **References Cited**

U.S. PATENT DOCUMENTS

D209,513 S * 12/1967 Walters et al. D13/158
4,356,368 A * 10/1982 Osika 200/307
D274,720 S * 7/1984 Hannich et al. D13/159

D296,433 S * 6/1988 Mizuno et al. D13/159
5,424,900 A * 6/1995 Kiiskinen et al. 361/116
5,652,420 A * 7/1997 Innes et al. 200/50.32
D468,687 S * 1/2003 Ide et al. D13/113
D480,364 S * 10/2003 Bluemel D13/159
D487,253 S * 3/2004 Nurdogan D13/159
6,856,503 B2 * 2/2005 Apfelbacher et al. 361/676

* cited by examiner

Primary Examiner—Daniel Bui

Assistant Examiner—Thomas J Johannes

(57) **CLAIM**

We claim the ornamental design for a modular decentral electronic motor starter, as shown and described.

DESCRIPTION

FIG. 1 is a front elevation view of a modular decentral electronic motor starter, showing our new design.

FIG. 2 is a right elevation view thereof.

FIG. 3 is the left elevation view thereof.

FIG. 4 is a rear elevation view thereof.

FIG. 5 is a top plan view thereof.

FIG. 6 is a bottom plan view thereof; and,

FIG. 7 is a perspective view of the motor starter.

The broken line showing in the figure drawings is included for illustrative purposes only and forms no part of the claimed design.

1 Claim, 7 Drawing Sheets

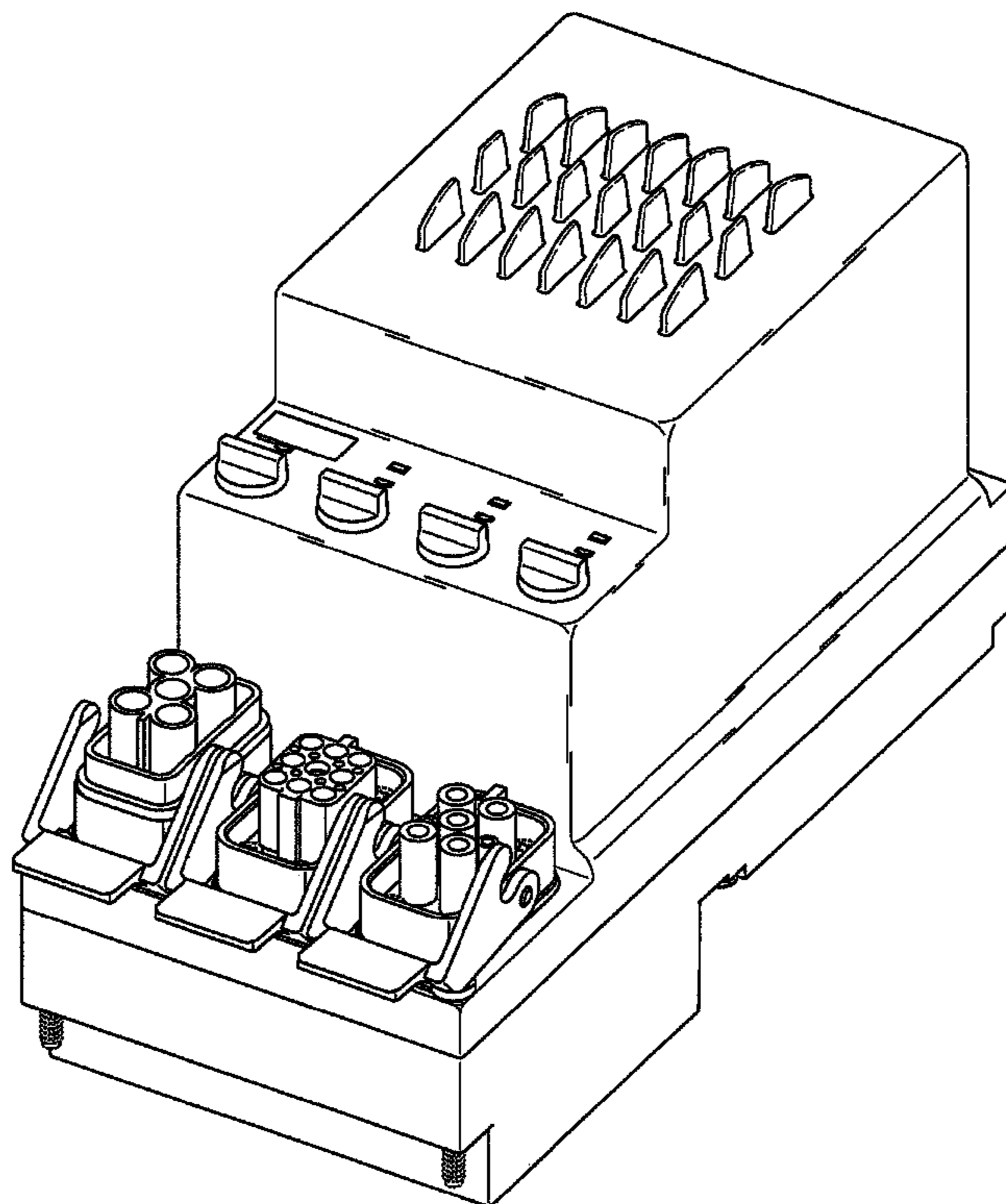

FIG 1

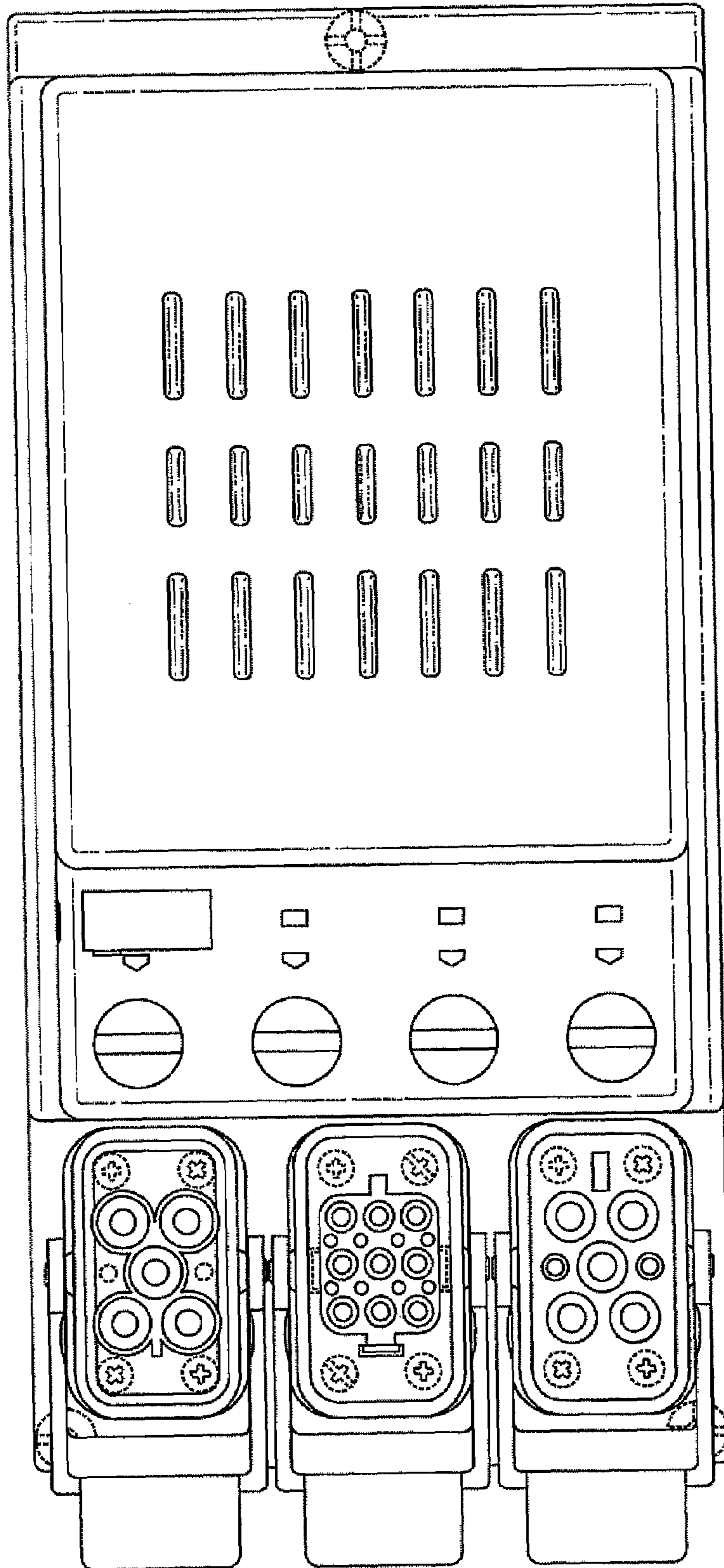

FIG 2

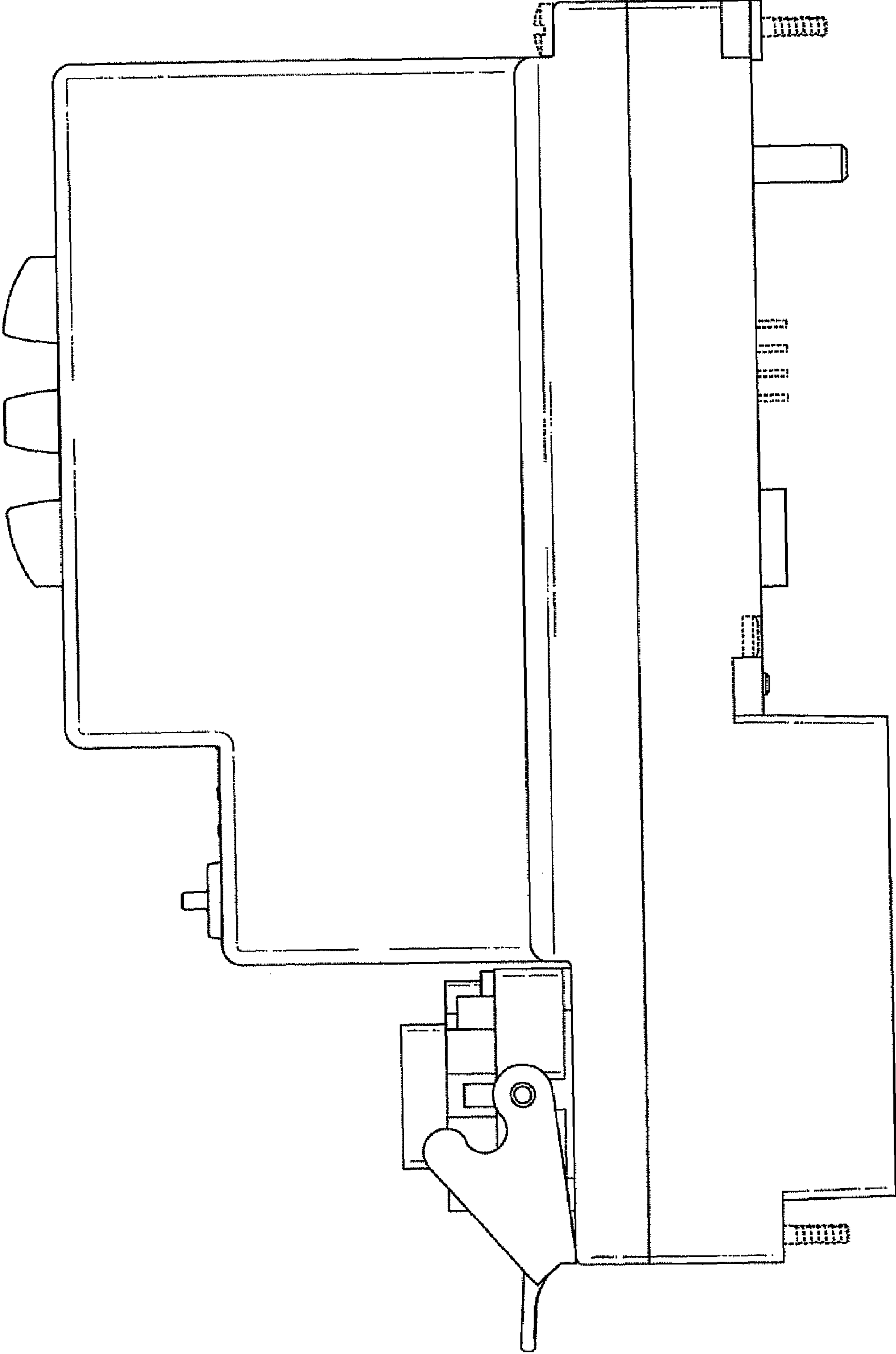

FIG 3

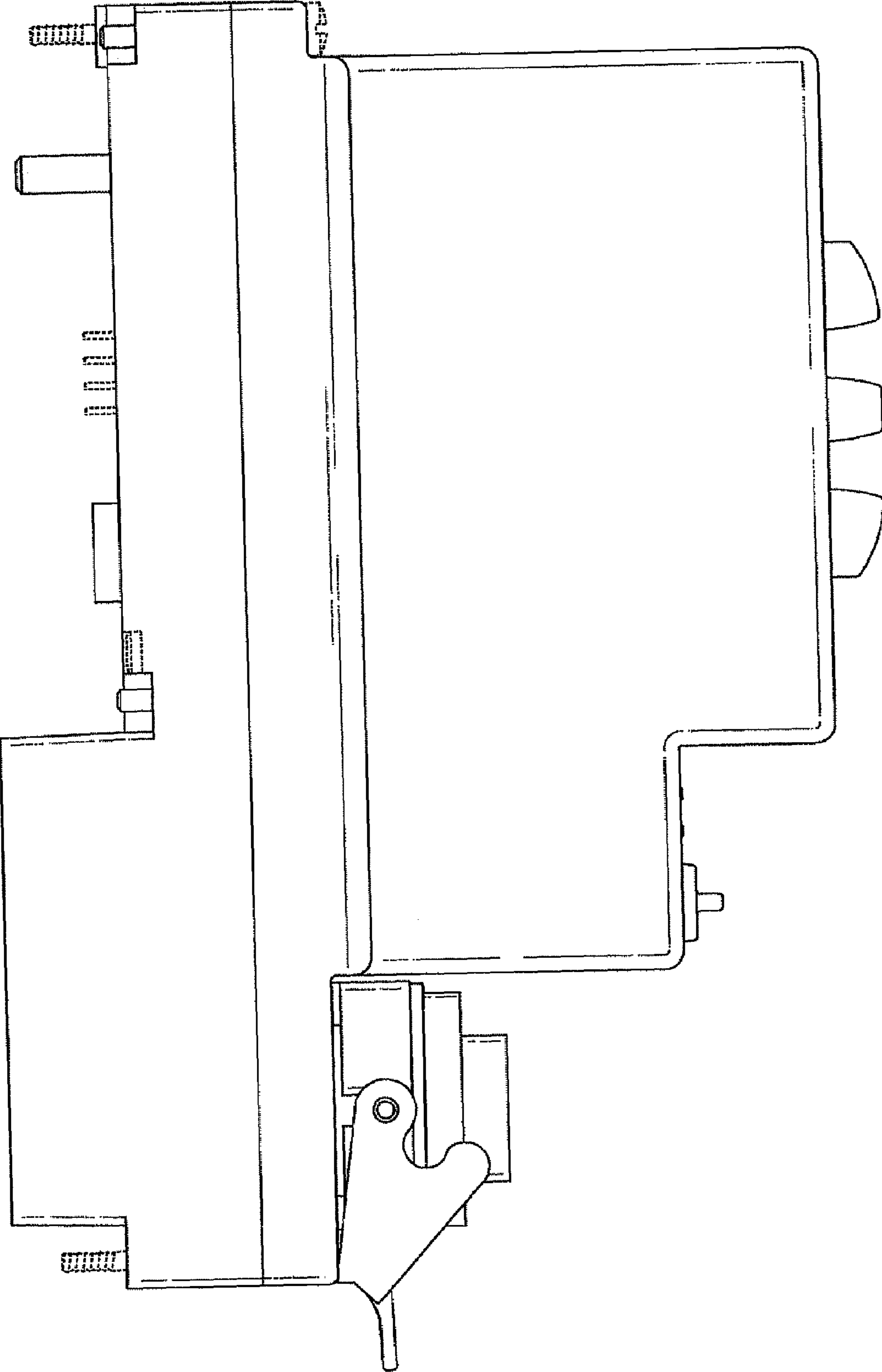

FIG 4

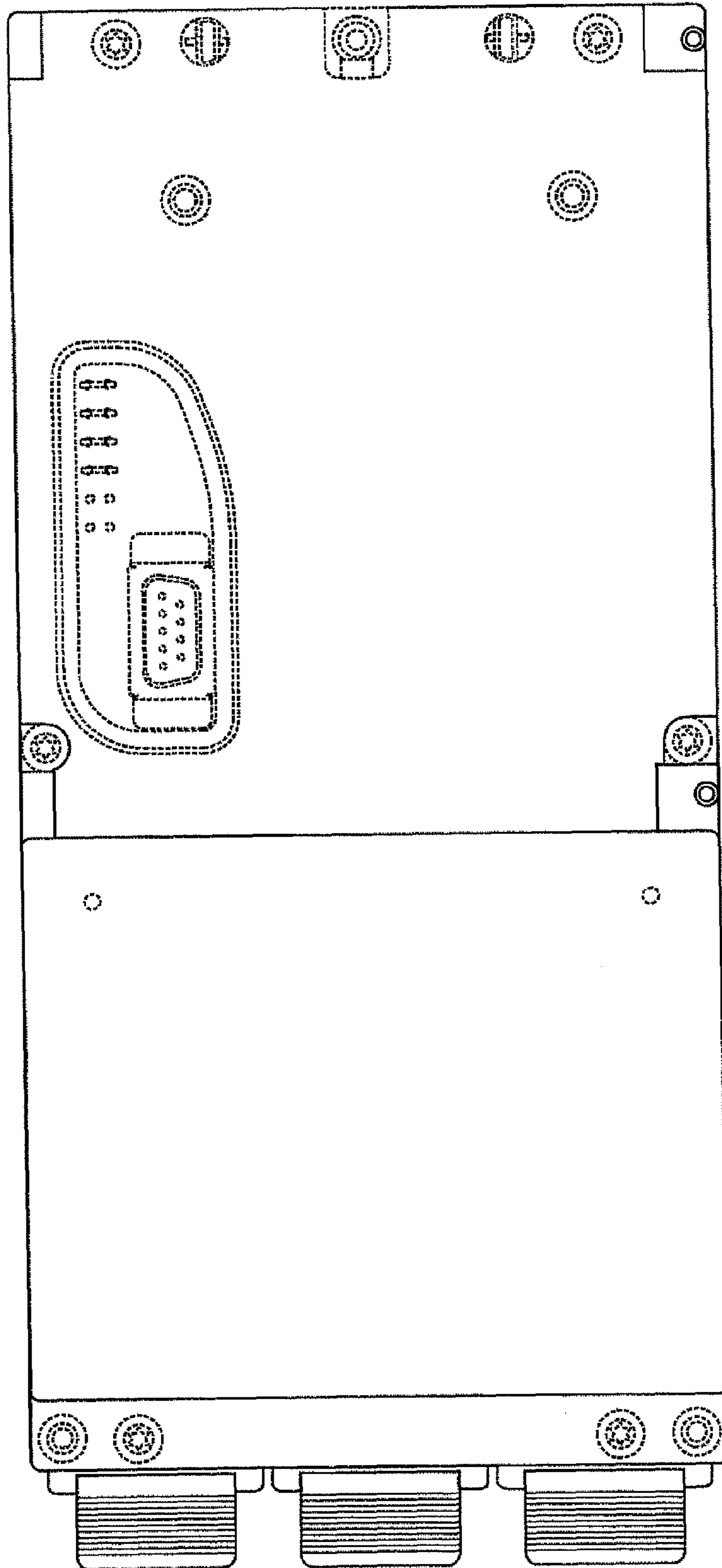

FIG 5

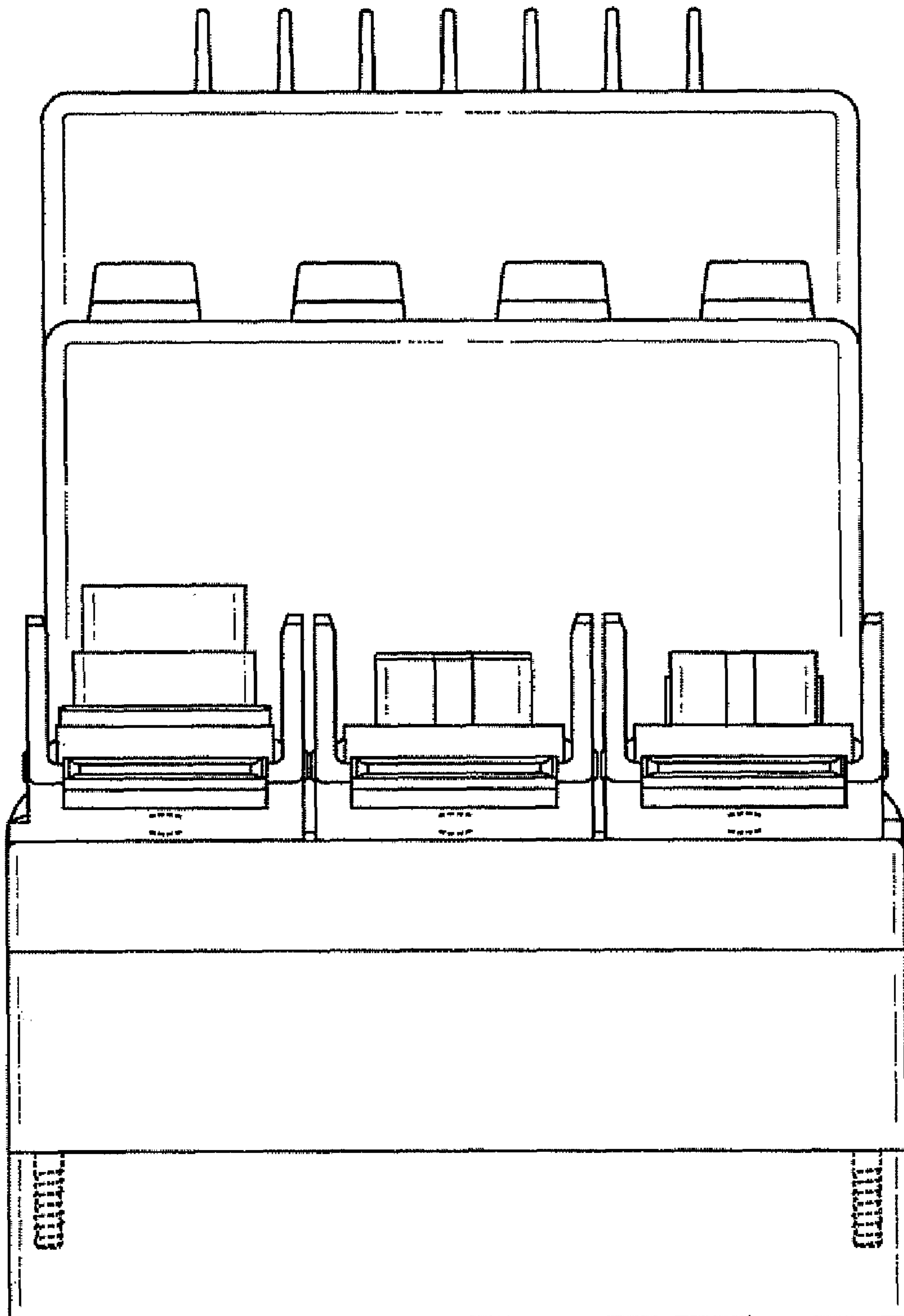

FIG 6

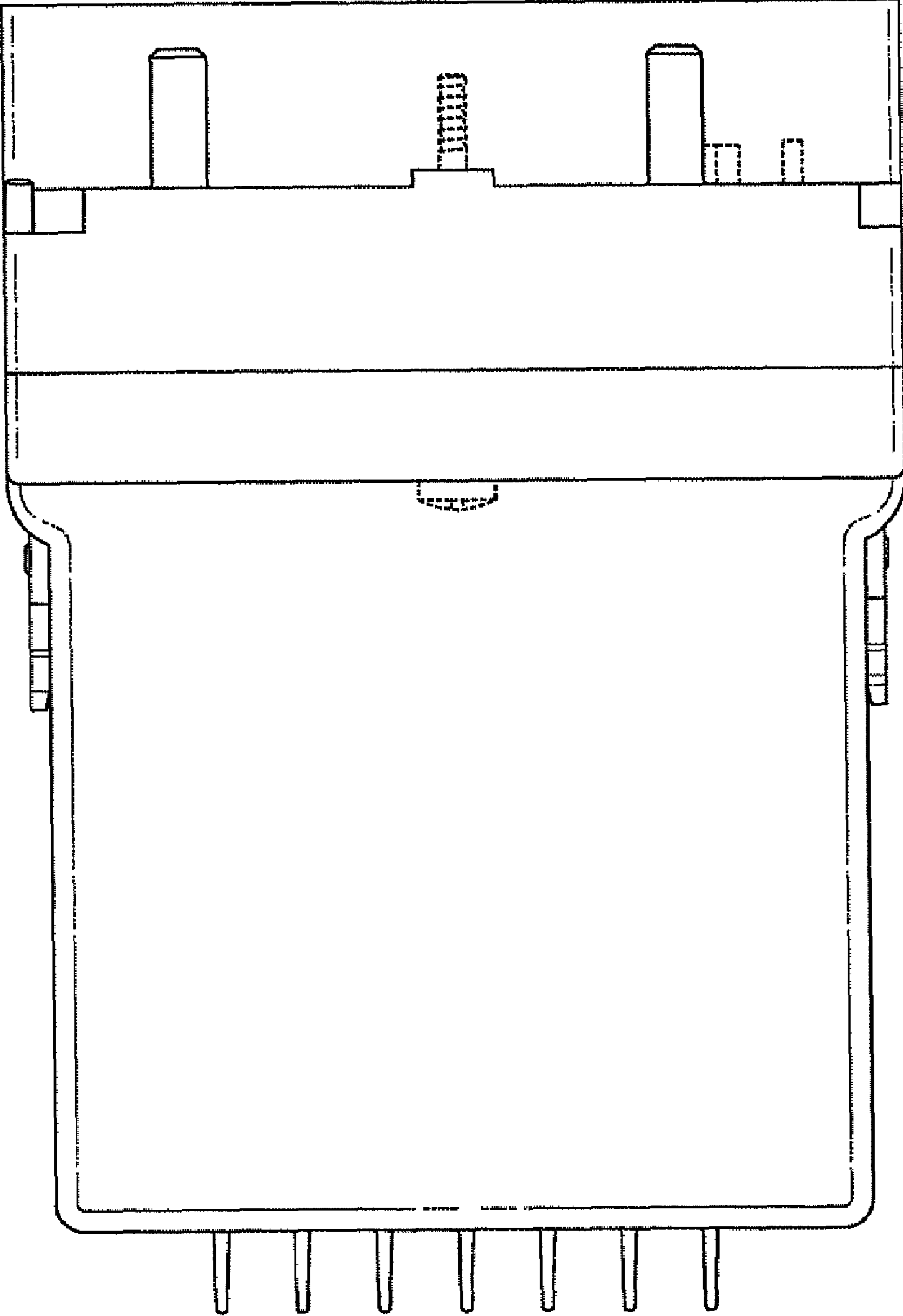

FIG 7

