



US00D577207S

(12) **United States Design Patent**
Tsai

(10) **Patent No.:** **US D577,207 S**

(45) **Date of Patent:** **** Sep. 23, 2008**

(54) **DIGITAL FRAME**

D546,789 S * 7/2007 Lee D14/126

(75) Inventor: **Stephen Tsai**, Taipei County (TW)

* cited by examiner

(73) Assignee: **Hannspree, Inc.**, Taipei (TW)

Primary Examiner—Caron D. Veynar

Assistant Examiner—Sydney R Buffalow

(**) Term: **14 Years**

(74) *Attorney, Agent, or Firm*—Ming Chow; Sinorica, LLC

(21) Appl. No.: **29/297,028**

(57) **CLAIM**

(22) Filed: **Nov. 1, 2007**

The ornamental design for a digital frame, as shown and described.

(51) **LOC (8) Cl.** **06-07**

(52) **U.S. Cl.** **D6/304; D14/371**

(58) **Field of Classification Search** D6/300,
D6/304, 598; D14/371–376, 448, 450, 125–129;
40/594, 700; 248/917–924; D21/610–619,
D21/597, 652

See application file for complete search history.

DESCRIPTION

FIG. 1. is a perspective view thereof;

FIG. 2. is a front elevational view thereof;

FIG. 3. is a rear elevational view thereof;

FIG. 4. is a left side elevational view thereof;

FIG. 5. is a right side elevational view thereof;

FIG. 6. is a top plan view thereof; and,

FIG. 7. is a bottom plan view thereof.

(56) **References Cited**

U.S. PATENT DOCUMENTS

D470,900 S * 2/2003 Steele-Kurtin et al. D21/616

D476,653 S * 7/2003 Zuege et al. D14/371

D485,556 S * 1/2004 Hoehn D14/371

1 Claim, 7 Drawing Sheets

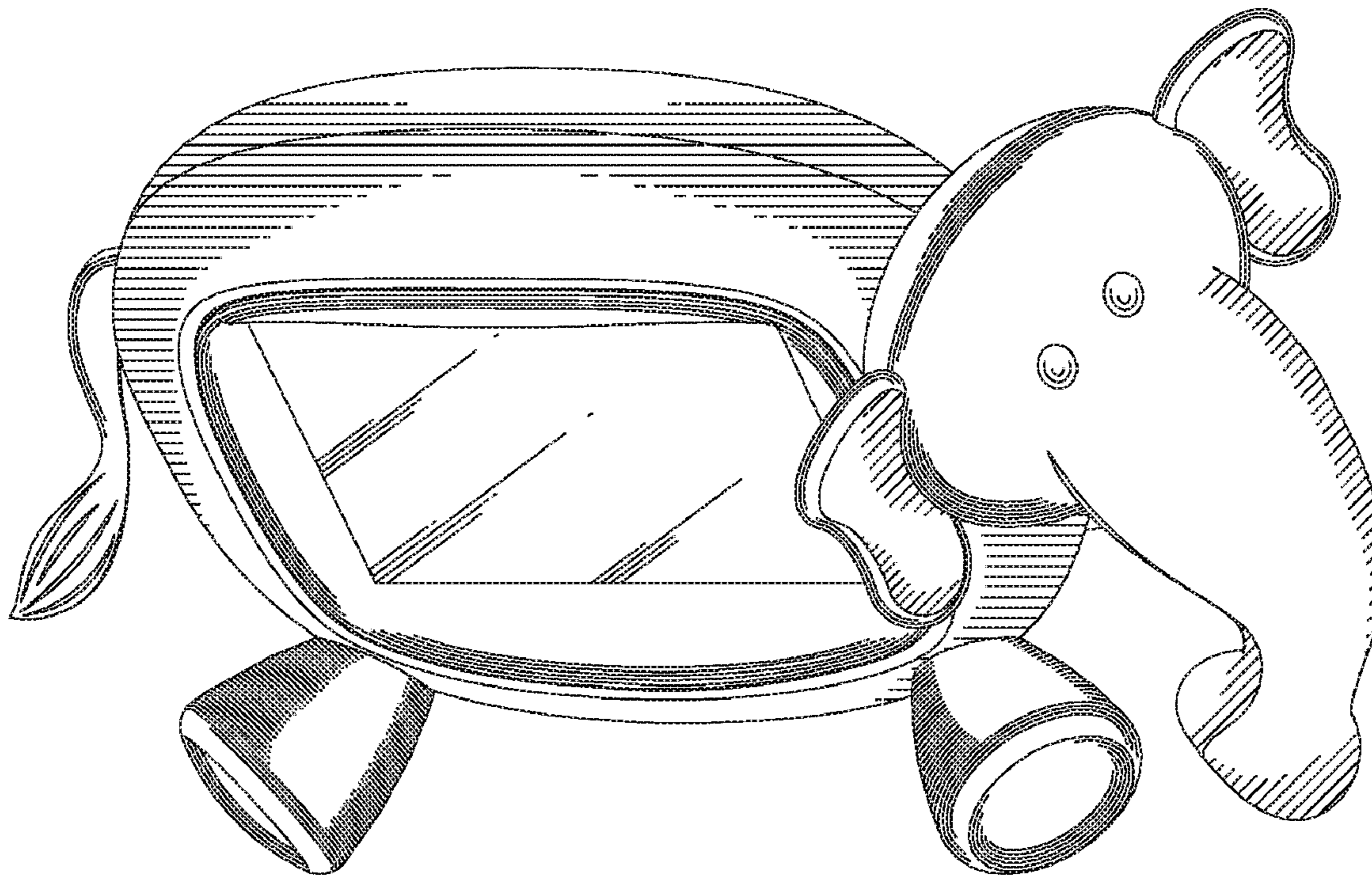

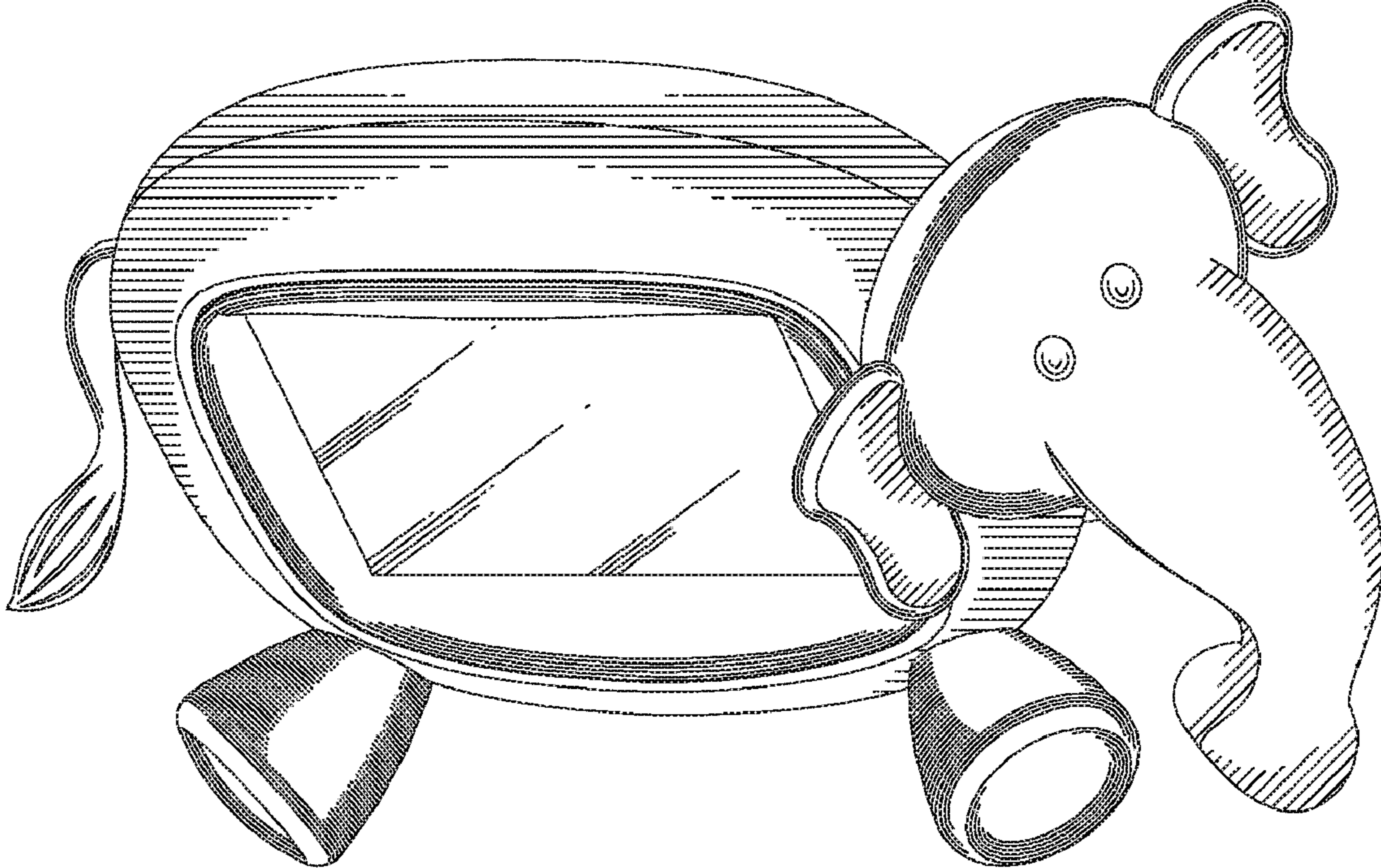

FIG. 1

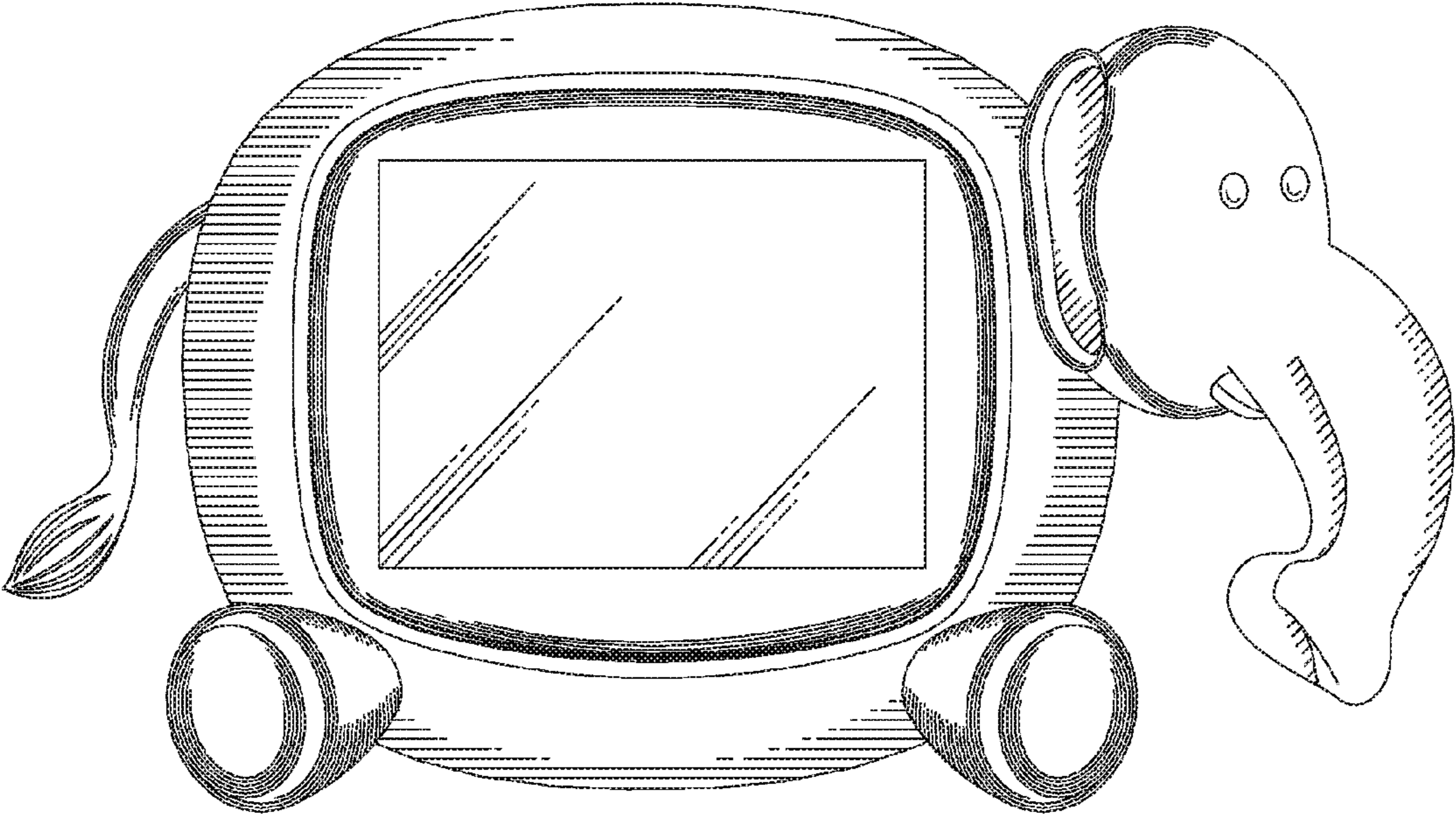

FIG. 2

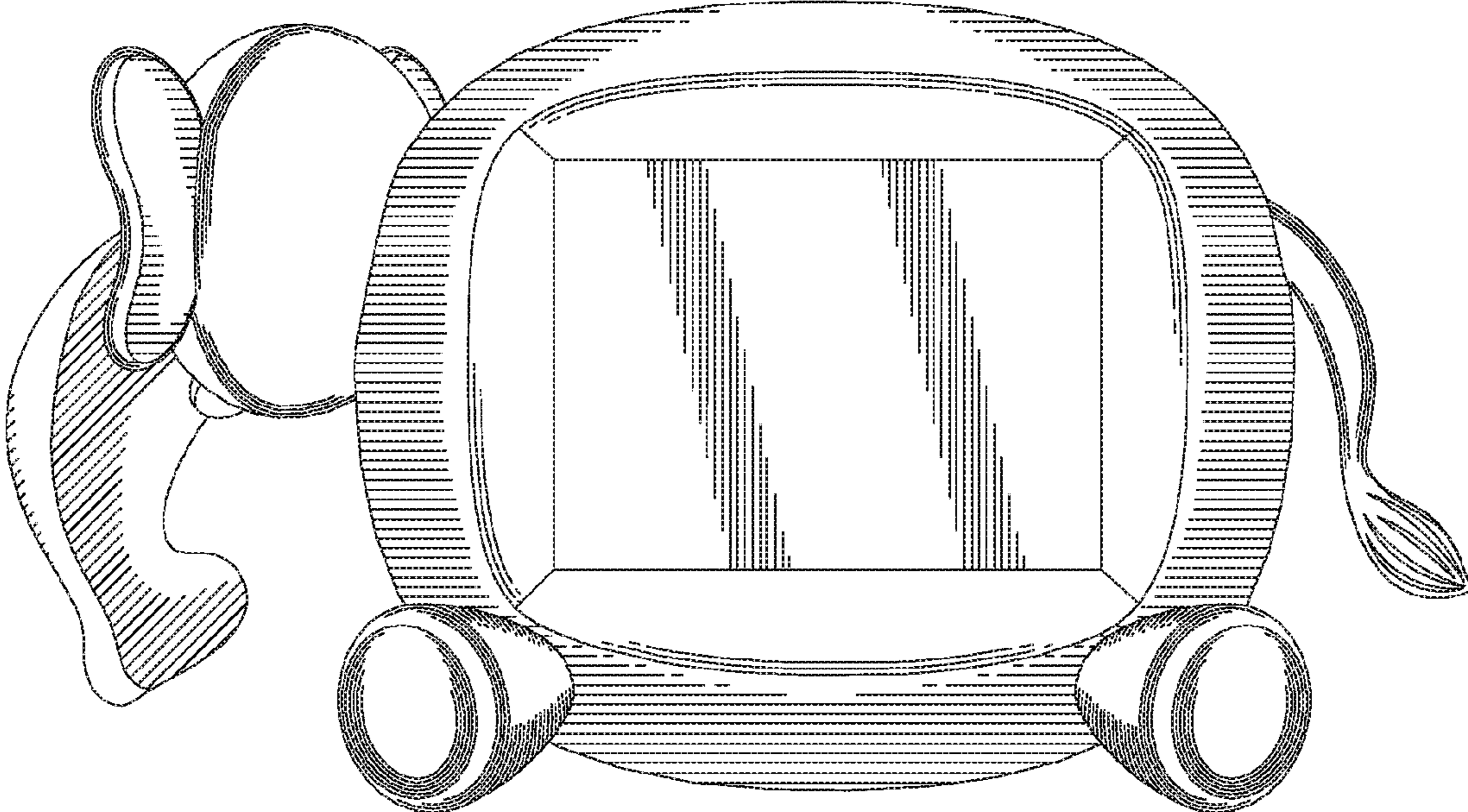

FIG. 3

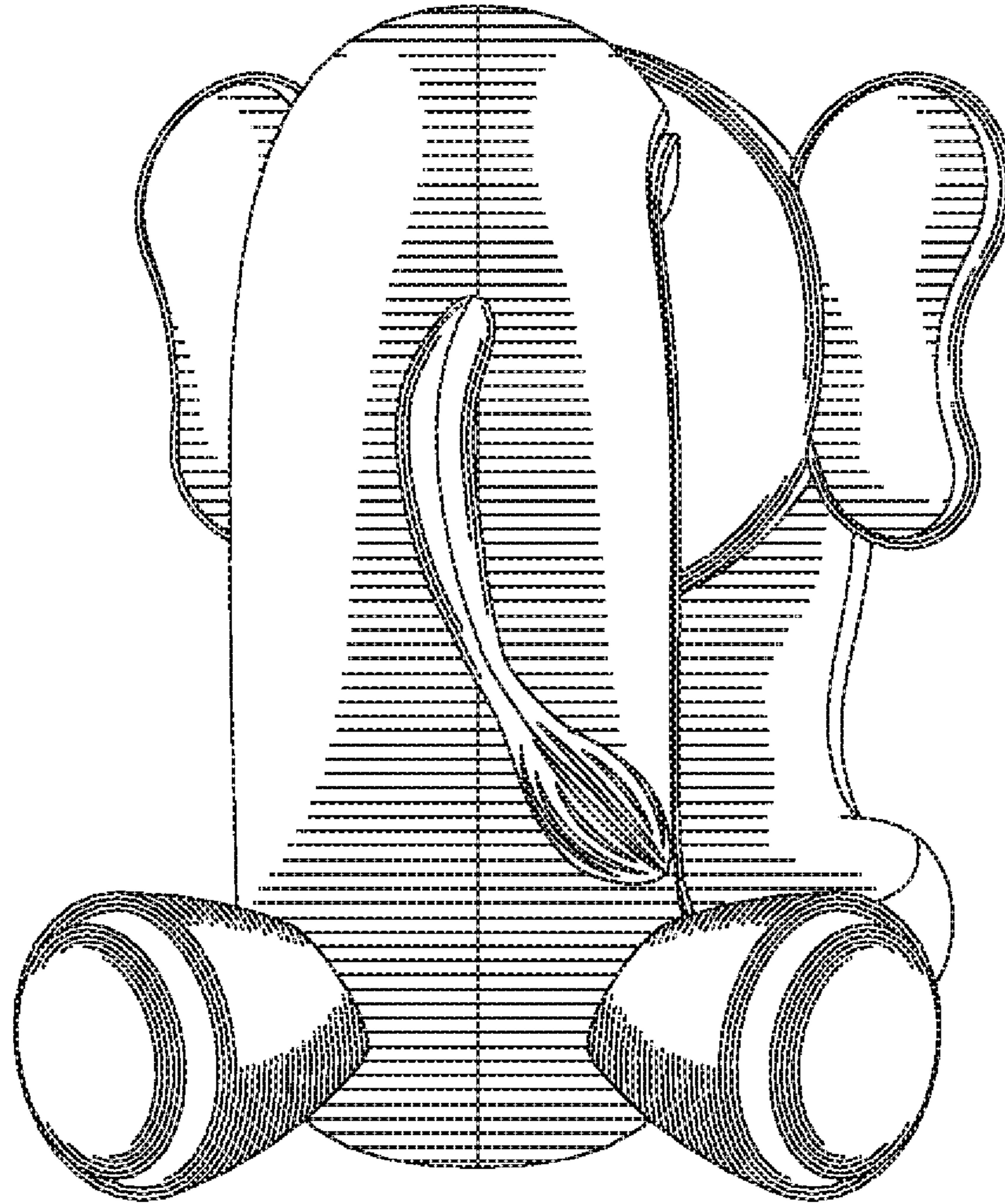

FIG. 4

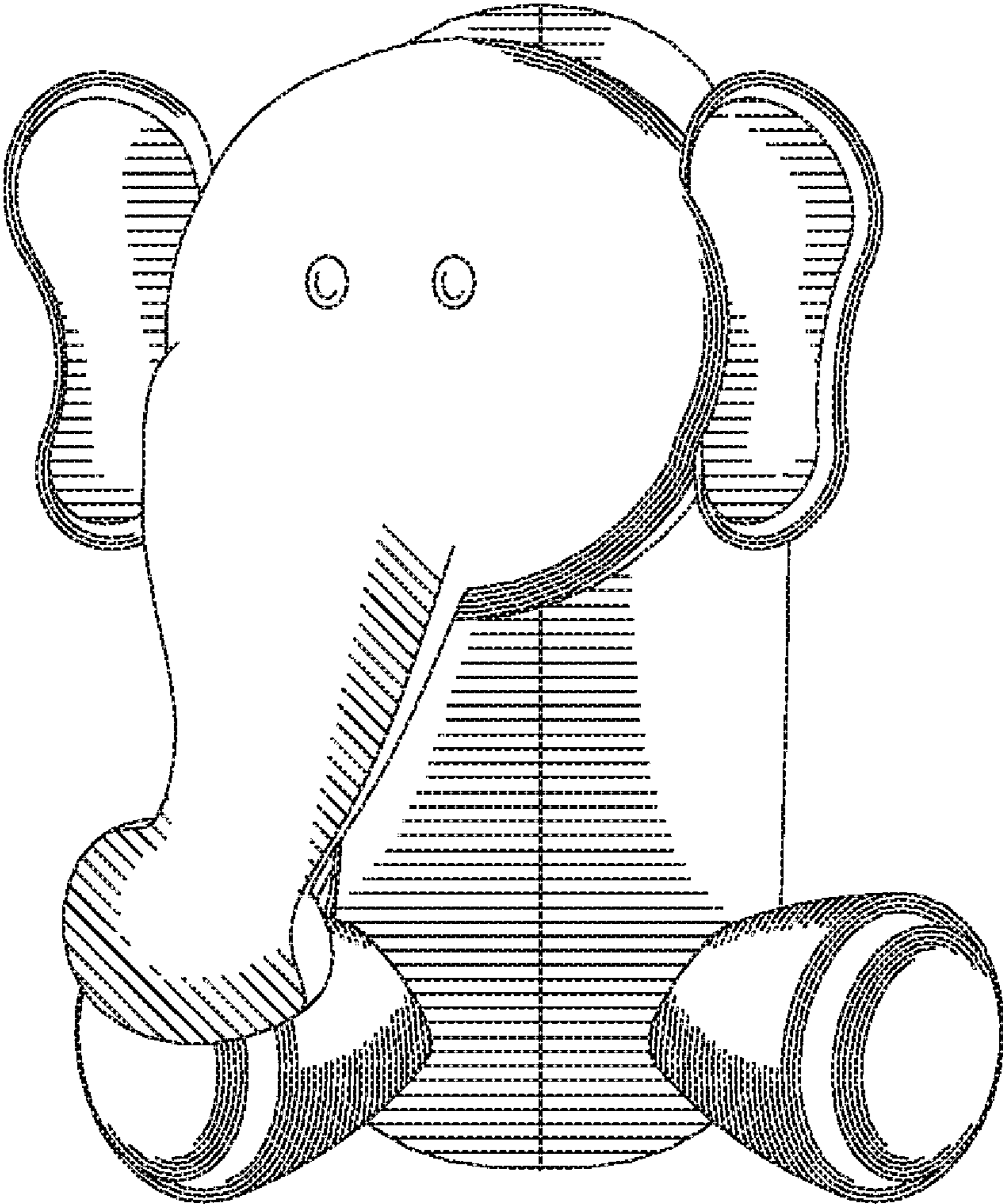

FIG. 5

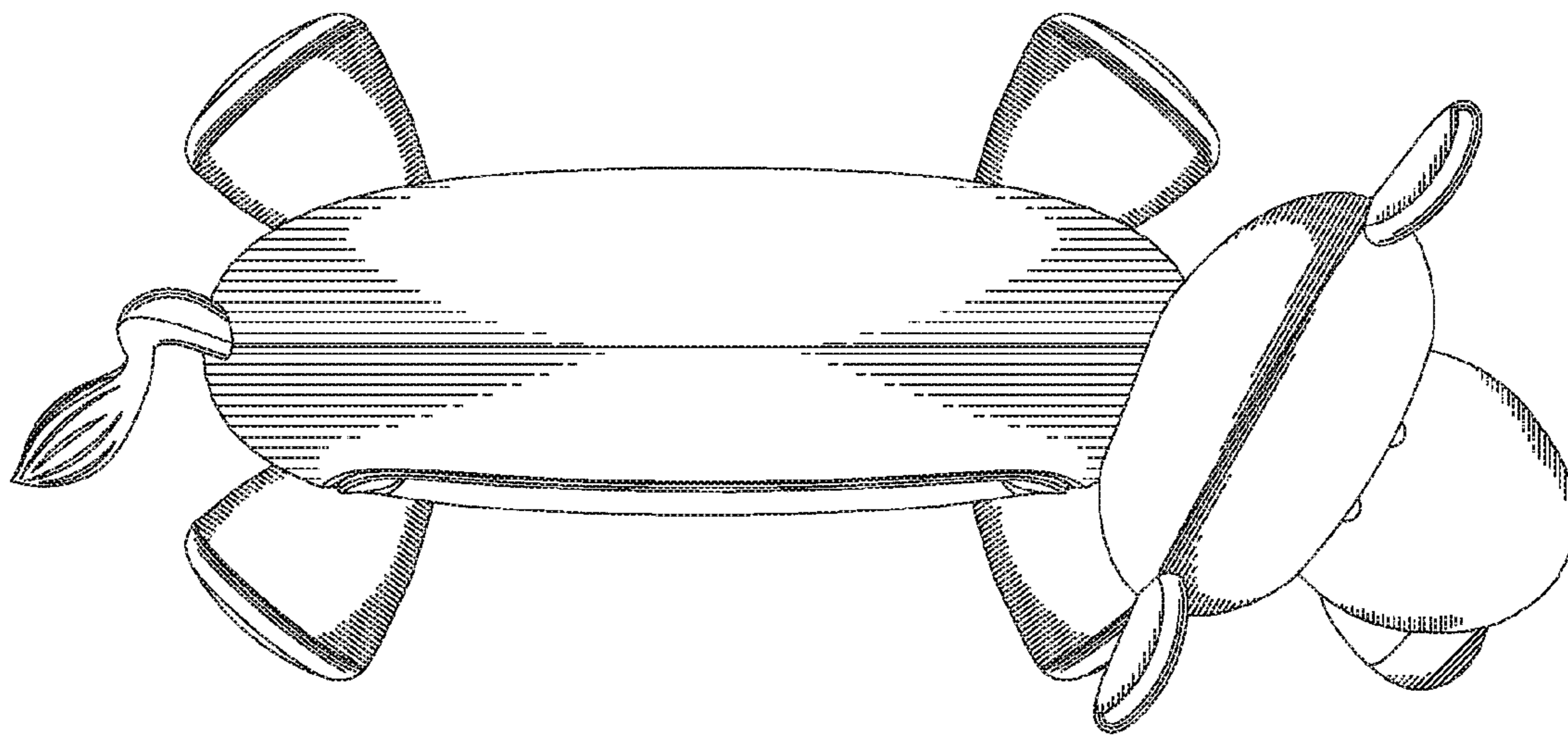

FIG. 6

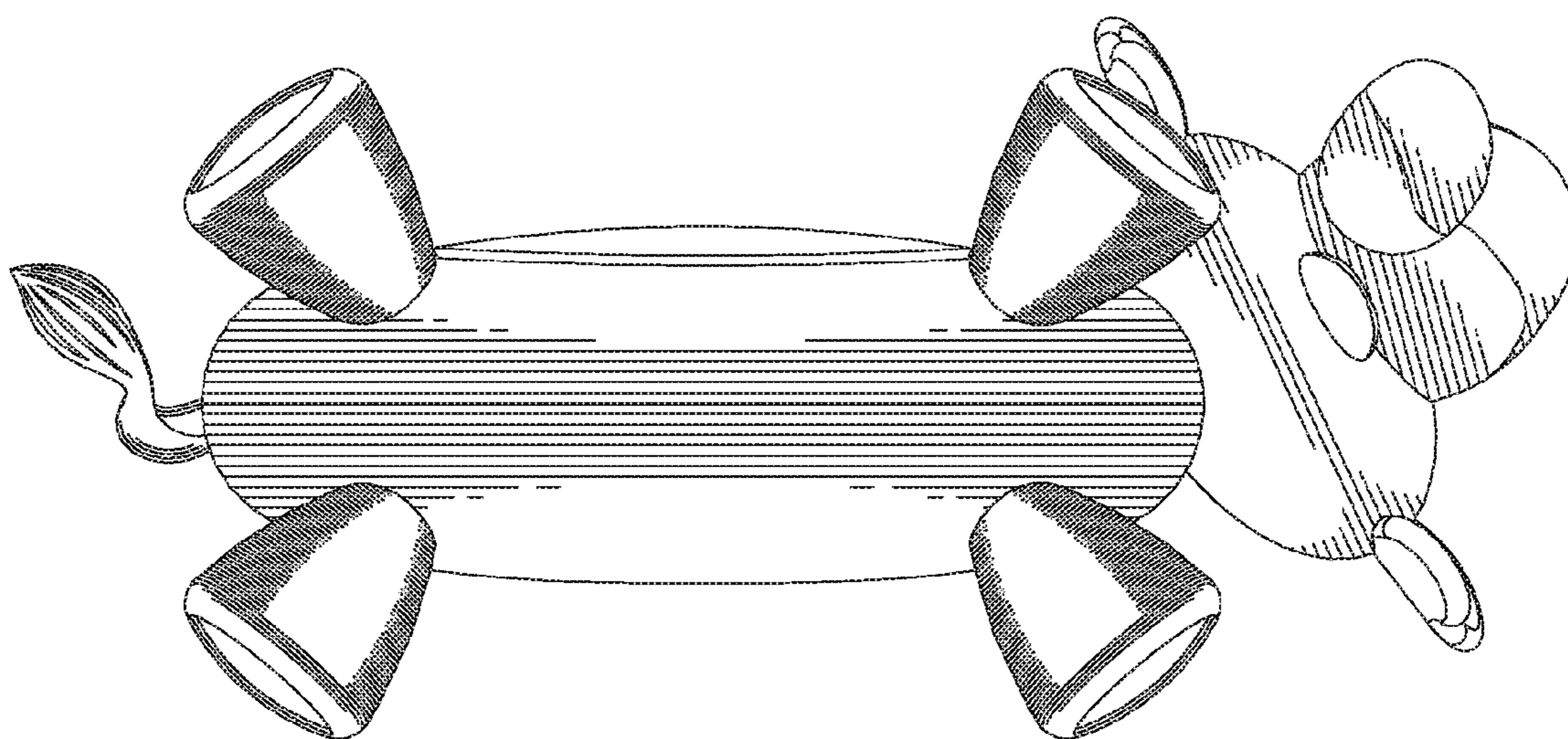

FIG. 7