



US00D577196S

(12) **United States Design Patent**  
**Hayden**

(10) **Patent No.:**           **US D577,196 S**  
(45) **Date of Patent:**   **\*\* Sep. 23, 2008**

(54) **STORAGE BOX**

(76) Inventor: **Janet Renee Hayden**, 1838 2nd Ave.  
#245, New York, NY (US) 10128

(\*\*) Term:       **14 Years**

(21) Appl. No.: **29/292,991**

(22) Filed:       **Nov. 5, 2007**

(51) **LOC (8) Cl.** ..... **03-01**

(52) **U.S. Cl.** ..... **D3/286; D3/290**

(58) **Field of Classification Search** ..... D3/206,  
D3/272-273, 276, 283-286, 290, 294-295,  
D3/302, 901, 903; D6/432, 434, 440; D19/75,  
D19/85-86; 190/107, 109, 110; 206/419-420,  
206/499, 575-576; 229/120.31, 120.36;  
312/204, 244, 902

See application file for complete search history.

(56)               **References Cited**

U.S. PATENT DOCUMENTS

- 250,296 A \* 11/1881 Stevens ..... 229/120.36
- 1,842,380 A \* 1/1932 Andrews ..... 229/120.36
- 2,247,341 A    6/1941 Anderson
- D159,221 S \* 7/1950 Nonas ..... D3/284
- 3,186,529 A \* 6/1965 Gilbert ..... 312/244
- 3,242,960 A \* 3/1966 Schwartzman ..... 229/120.31
- 4,437,713 A    3/1984 Roach
- D281,836 S \* 12/1985 Sparkman ..... D3/203.7
- 4,729,474 A    3/1988 Lanius et al.
- 4,763,787 A \* 8/1988 Koenig ..... 206/420
- 4,826,012 A \* 5/1989 Kosanovich ..... 206/499
- 4,895,256 A    1/1990 Johnston
- 5,244,095 A    9/1993 DeVoe
- D353,047 S \* 12/1994 Lackie ..... D3/276
- 5,501,338 A    3/1996 Preston
- D380,299 S    7/1997 Schlaeger et al.
- 5,653,339 A    8/1997 Dobson
- D394,749 S    6/1998 Ford et al.
- 5,816,407 A   10/1998 Daratony
- D402,106 S \* 12/1998 Buckingham et al. .... D3/284
- 5,915,553 A    6/1999 Brown et al.
- D422,788 S    4/2000 Carr

- D439,740 S \* 4/2001 Harris ..... D3/276
- 6,334,536 B1  1/2002 Kanning
- 6,401,928 B1  6/2002 Horton
- D460,259 S \* 7/2002 Oelfke ..... D3/284
- D485,682 S    1/2004 Wolf
- D510,189 S \* 10/2005 Greiner ..... D3/295
- 7,044,277 B2 \* 5/2006 Redzisz ..... 190/107
- 7,111,732 B1   9/2006 Houlter et al.
- 7,143,932 B2 \* 12/2006 Wang ..... 229/117.35
- D563,105 S \* 3/2008 Rothschild ..... D3/302

OTHER PUBLICATIONS

<https://www.sterlingpear.com/see-more-images/keepsake-ornament-storage-chest/91...> Downloaded May 26, 2008.\*

\* cited by examiner

*Primary Examiner*—T. Chase Nelson  
*Assistant Examiner*—RoseLynne Cody

(74) *Attorney, Agent, or Firm*—Law Office of Alozie N. Etufugh PLLC

(57)               **CLAIM**

The ornamental design for a storage box, as shown and described.

**DESCRIPTION**

FIG. 1 is a perspective view of the present invention with the storage box shown closed;

FIG. 2 is a front perspective view of the storage box as shown in a closed position;

FIG. 3 is a rear view of the storage box thereof;

FIG. 4 is a right side elevational view, which is a mirror image of the left side view, thereof;

FIG. 5 is a top view thereof;

FIG. 6 is a bottom view thereof;

FIG. 7 is a perspective view of the storage box showing the lid of the box open and a top tray within the box with the tray compartments shown in dotted lines for illustrative purposes only;

FIG. 8 is a perspective view of the storage box with its lid open and showing three trays which normally reside within

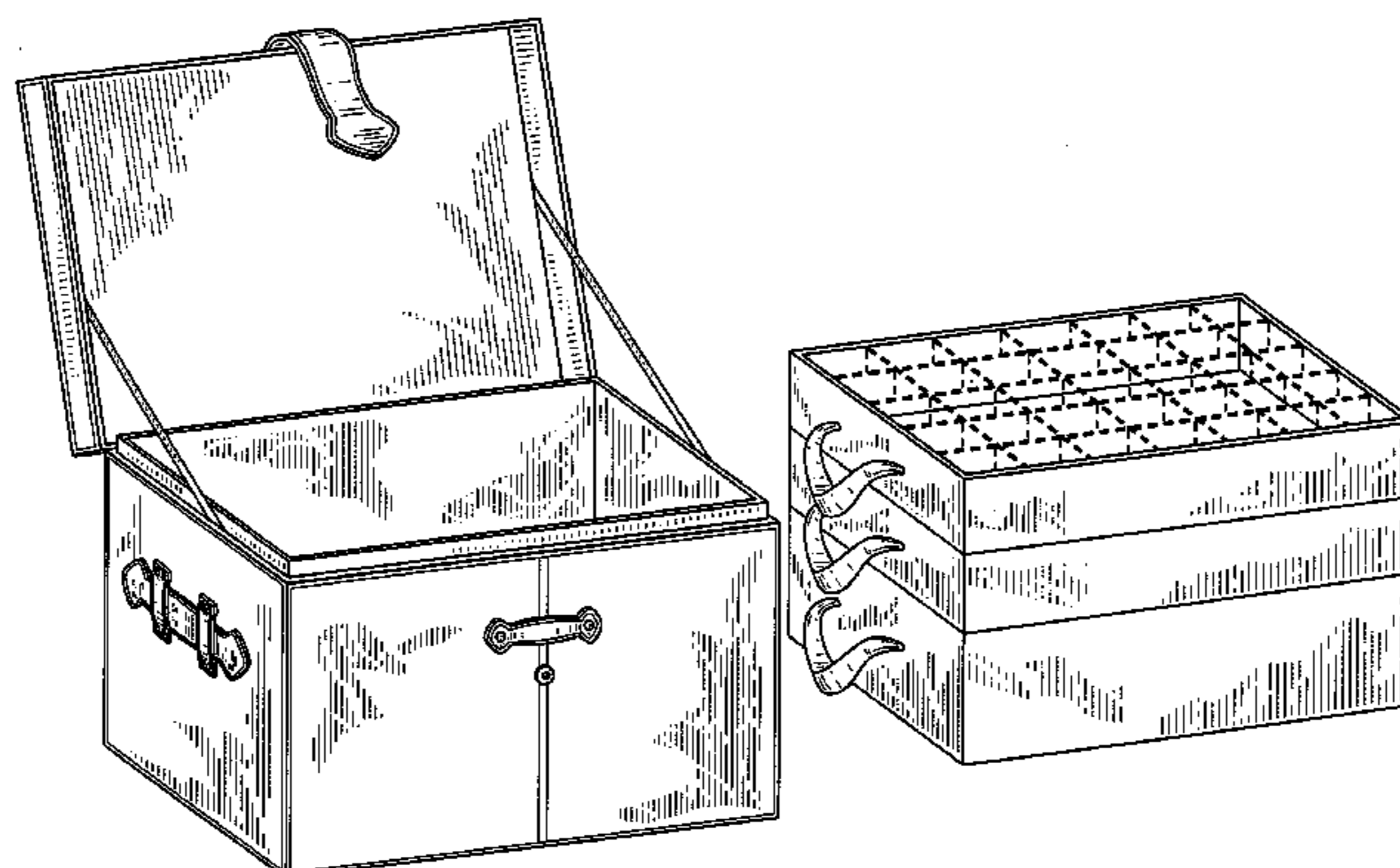

the storage box stacked on top of each other and with the compartments of the top tray shown in dotted lines for illustrative purposes only;

FIG. 9 is a front view of the storage box with its lid open alongside three trays which normally reside within the storage box;

FIG. 10 is a rear view of the storage box with its lid open alongside three trays which normally reside within the storage box;

FIG. 11 is a left side view of the storage box, which is a mirror image of the right side view, with its lid open alongside three trays which normally reside within the storage box;

FIG. 12 is a top view of the storage box with its lid open and alongside three trays which normally reside within the storage box with the compartments of the top tray shown in dotted lines for illustrative purposes only;

FIG. 13 is a bottom view of the storage box with its lid open and alongside three trays which normally reside within the storage box;

FIG. 14 is a perspective view of the storage box with its lid open alongside one tray which normally resides within the storage box with the compartments of the tray shown in dotted lines for illustrative purposes only;

FIG. 15 is a front view of the storage box with its lid open alongside one tray which normally resides within the storage box;

FIG. 16 is a rear view of the storage box with its lid open alongside one tray which normally resides within the storage box;

FIG. 17 is a left side view of the storage box, which is a mirror image of the right side view, with its lid open alongside one tray which normally resides within the storage box;

FIG. 18 is a top view of the storage box with its lid open and alongside one tray which normally resides within the storage box with the compartments of the tray shown in dotted illustrative purposes only; and,

FIG. 19 is a bottom view of the storage box with its lid open and alongside one tray which normally resides within the storage box.

The dotted lines in shown in FIGS. 7, 8, 12, 14, and 18 are directed to environment and are for illustrative purposes only, forming no part of the claimed design.

**1 Claim, 17 Drawing Sheets**

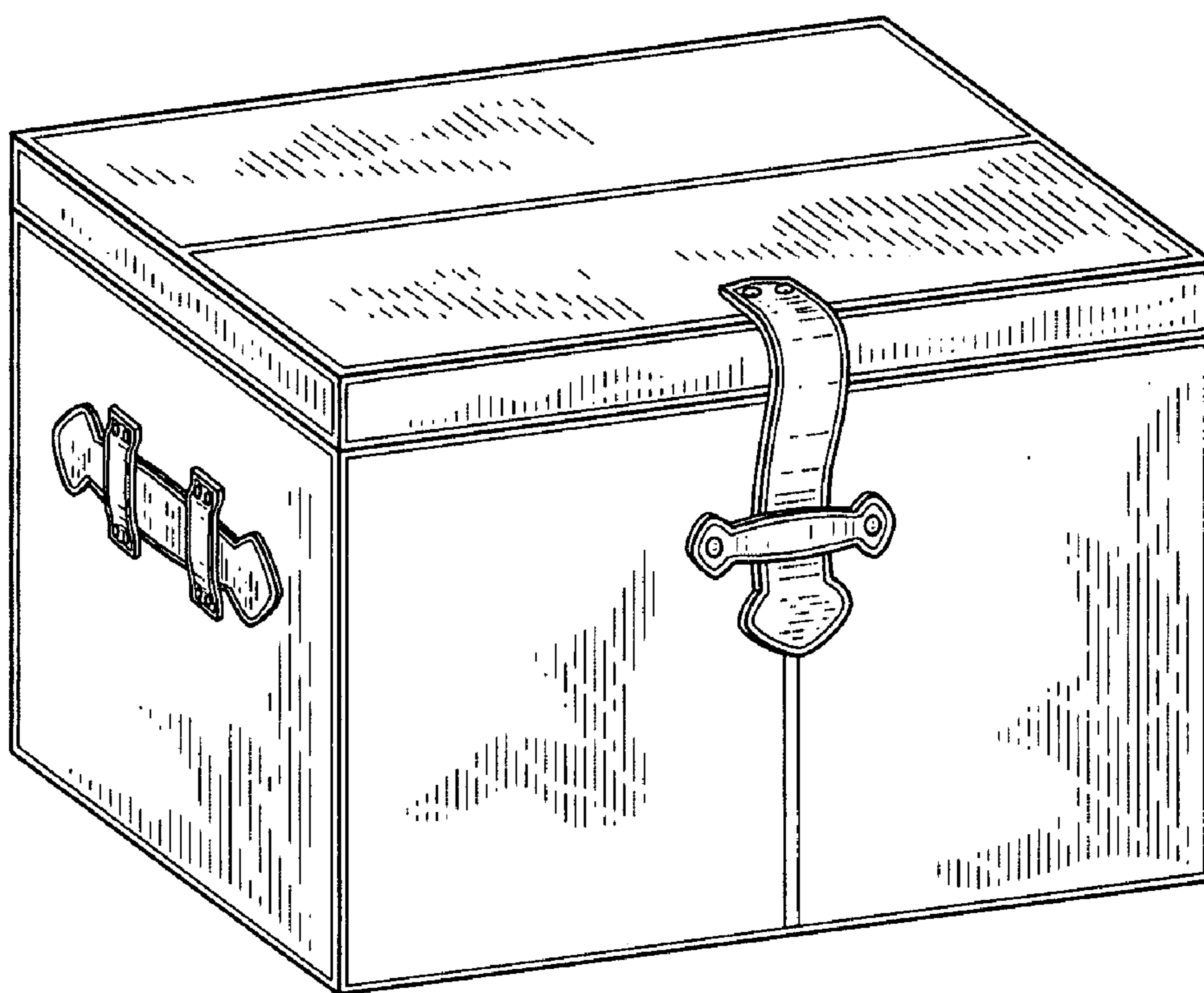

FIG. 1

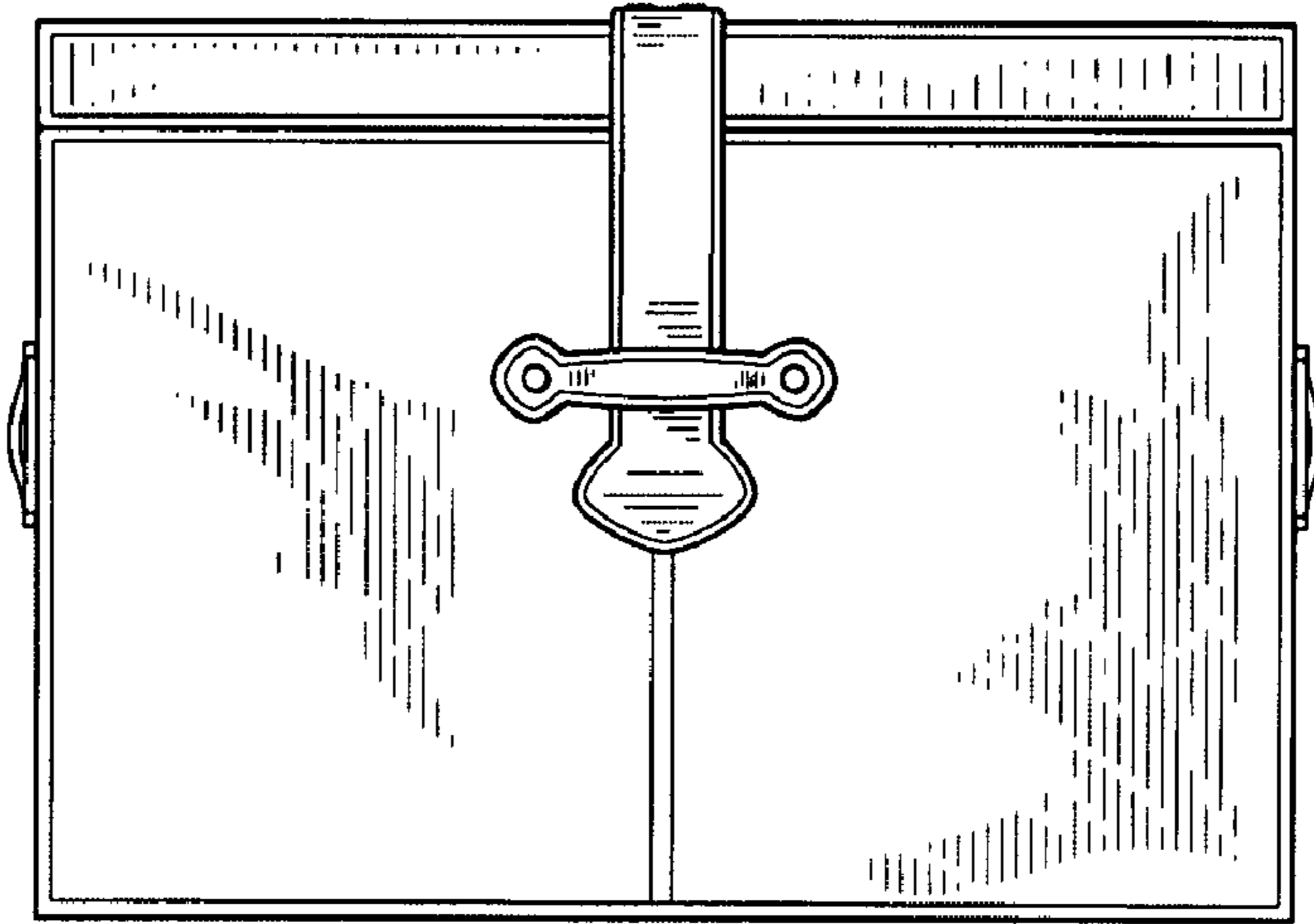

FIG. 2

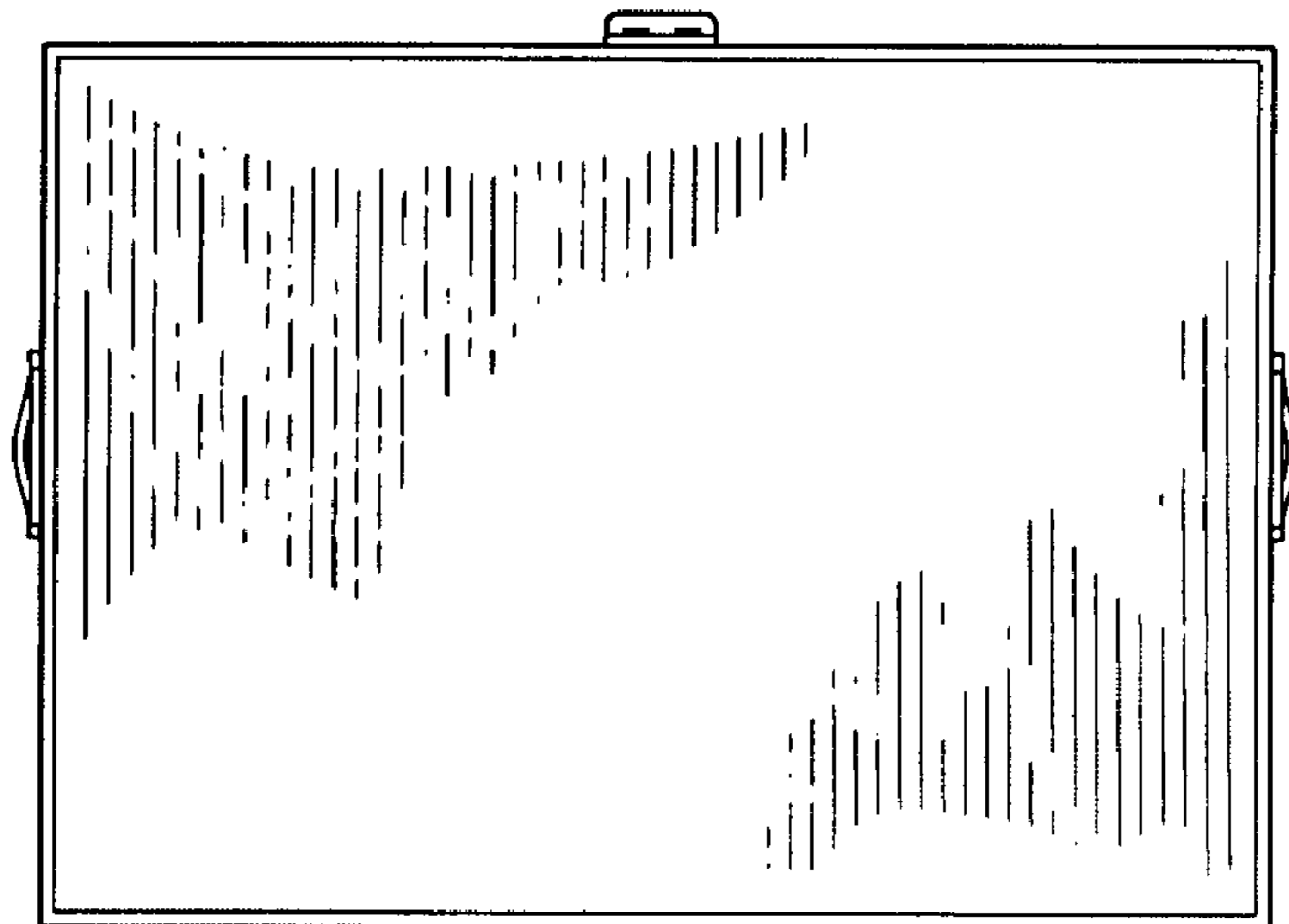

FIG. 3

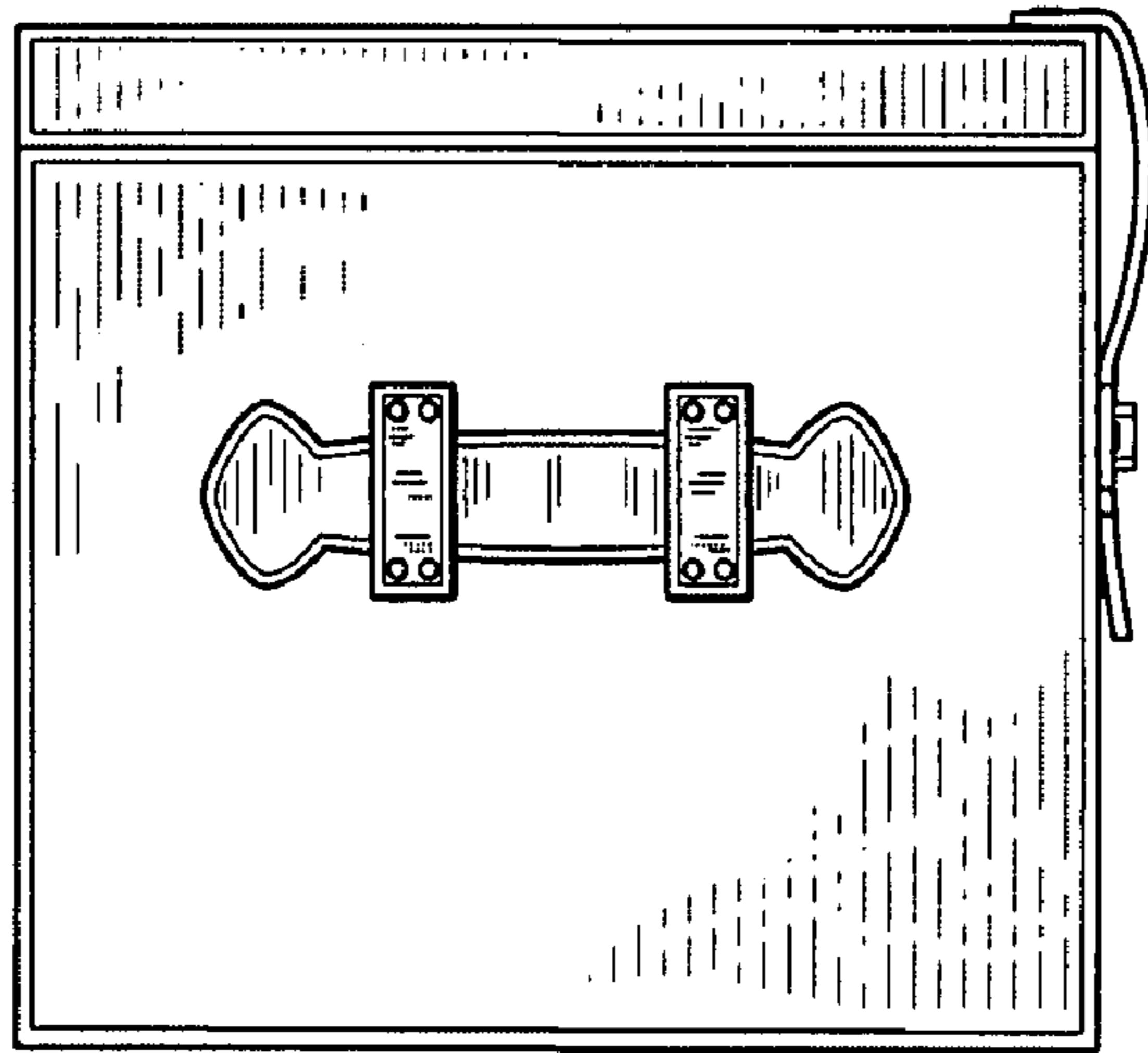

FIG. 4

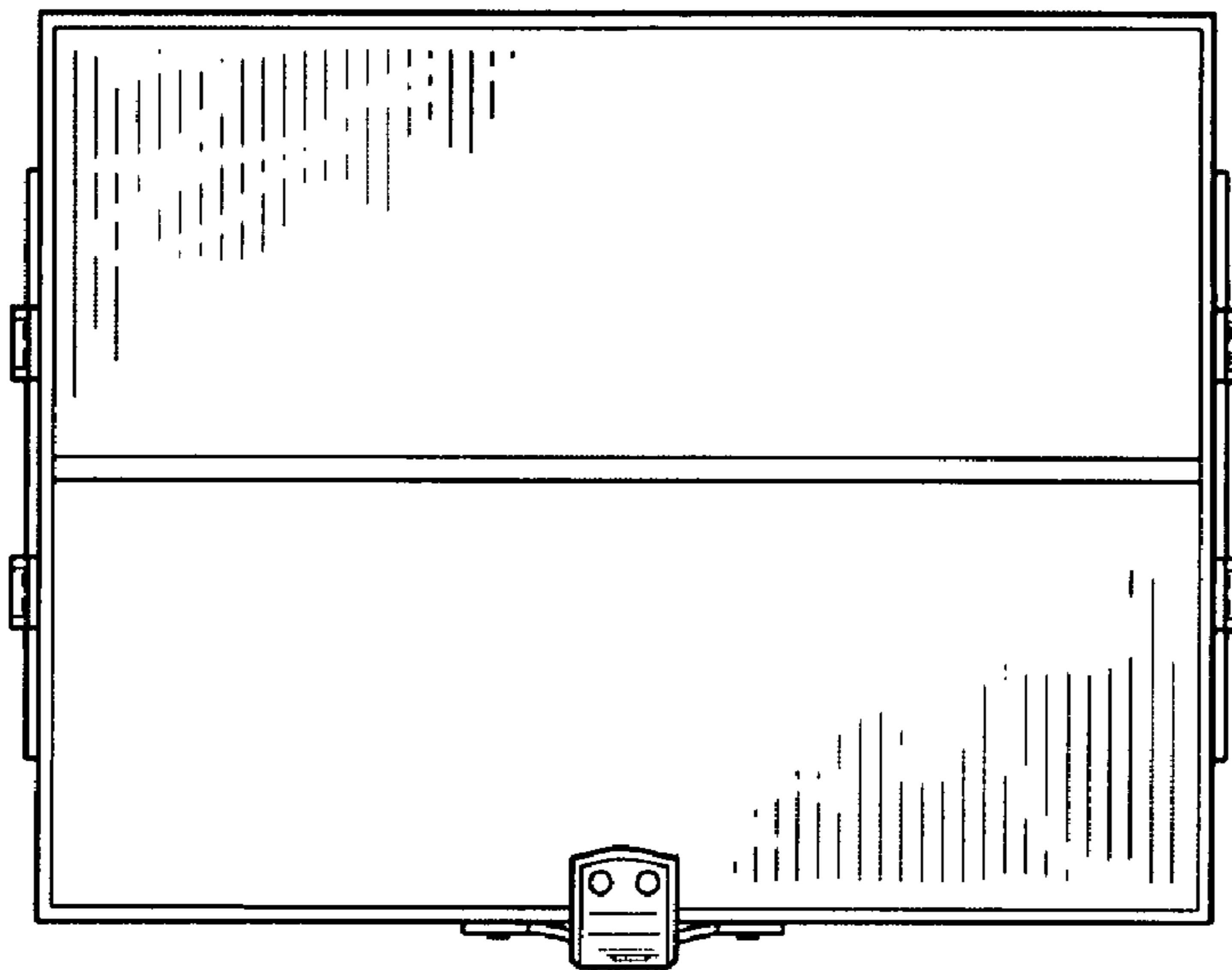

FIG. 5

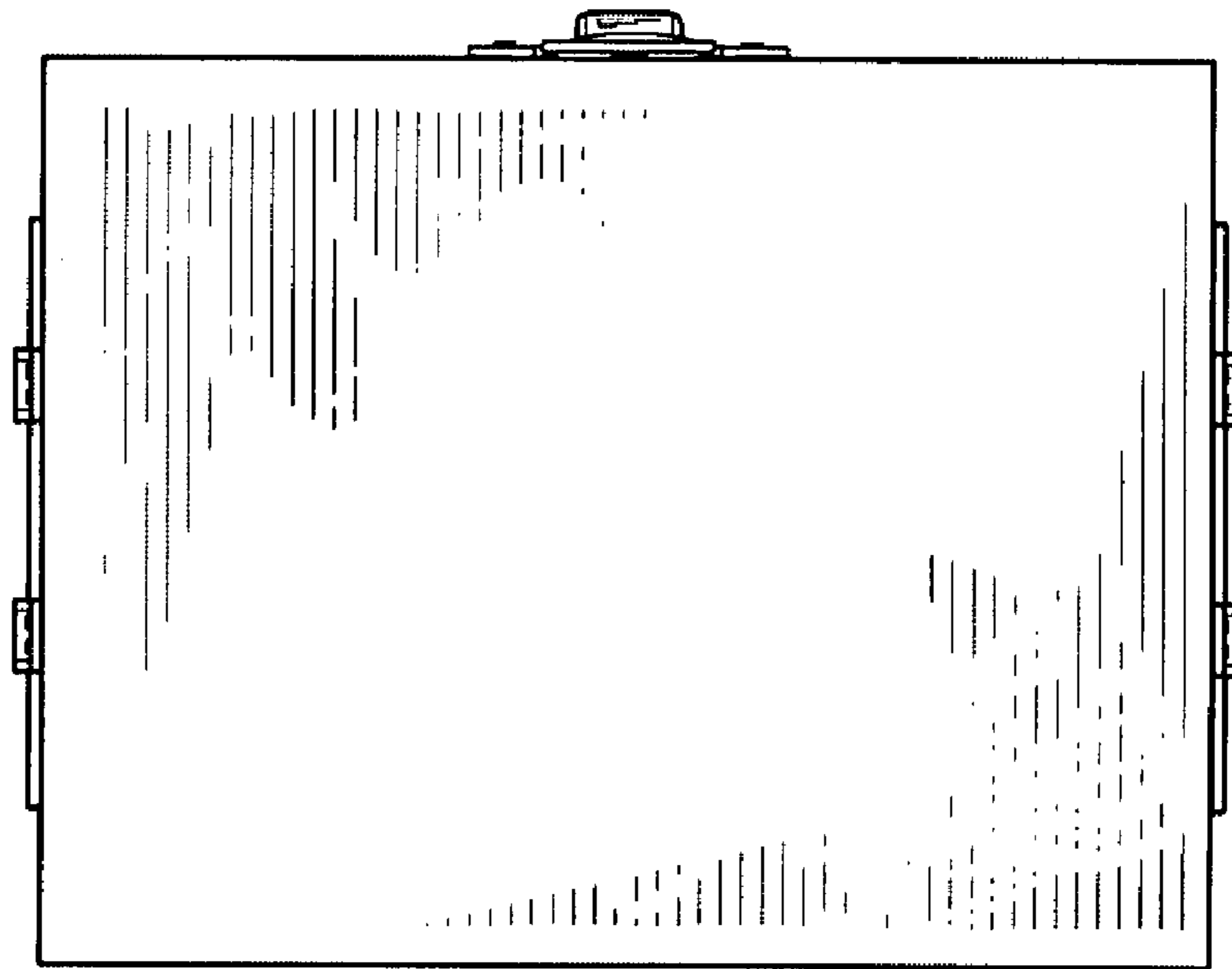

FIG. 6

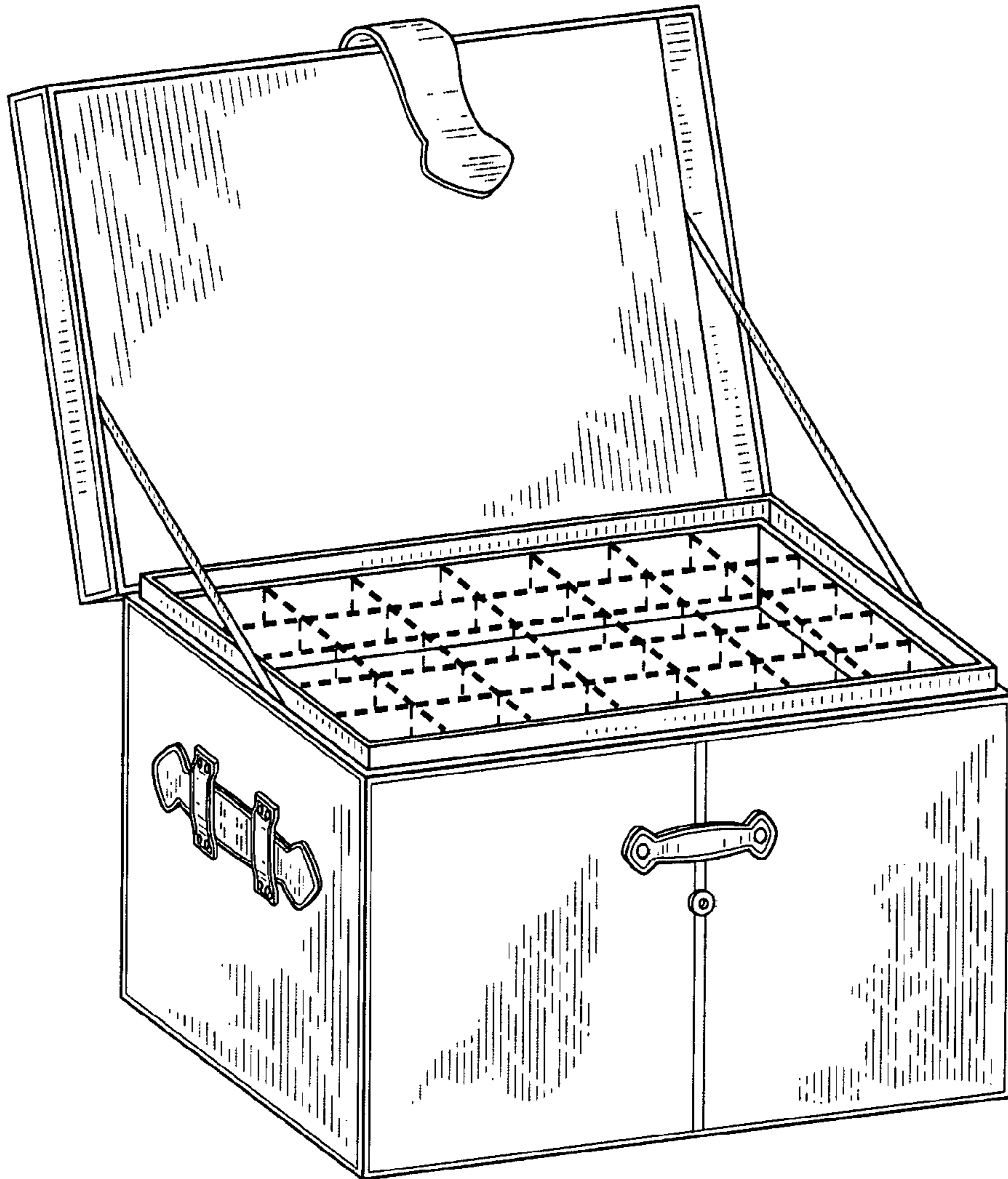

FIG. 7

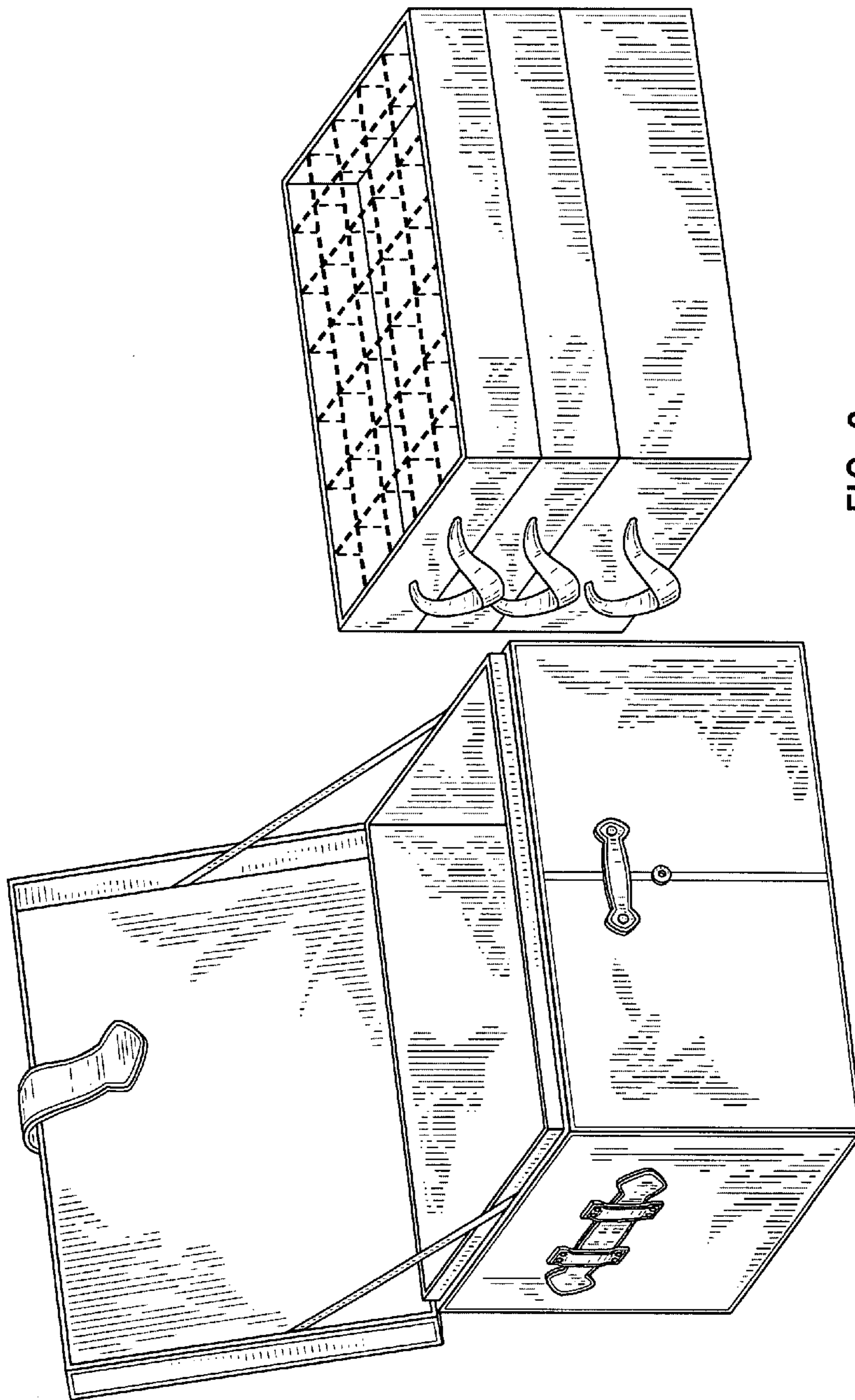

FIG. 8



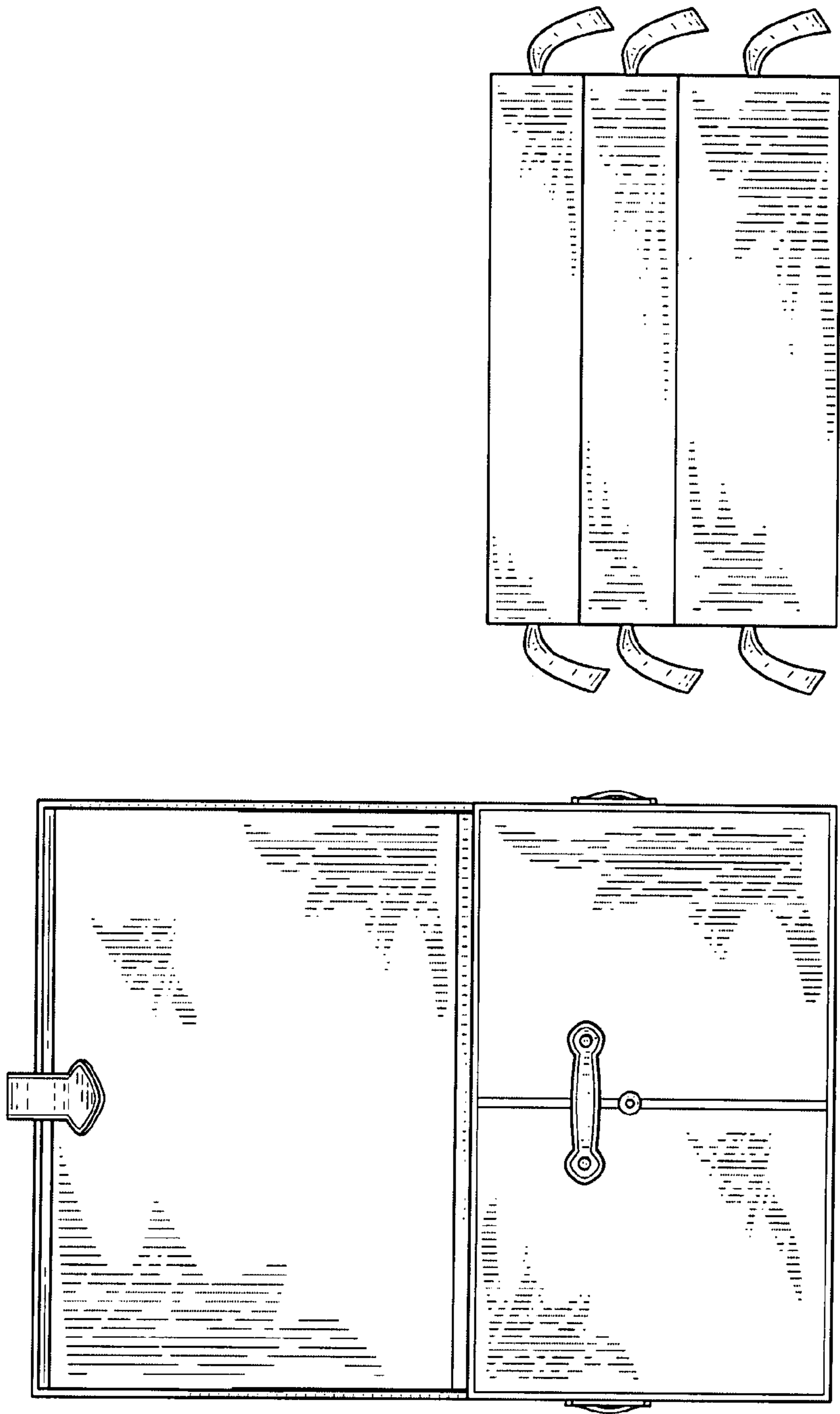

FIG. 9

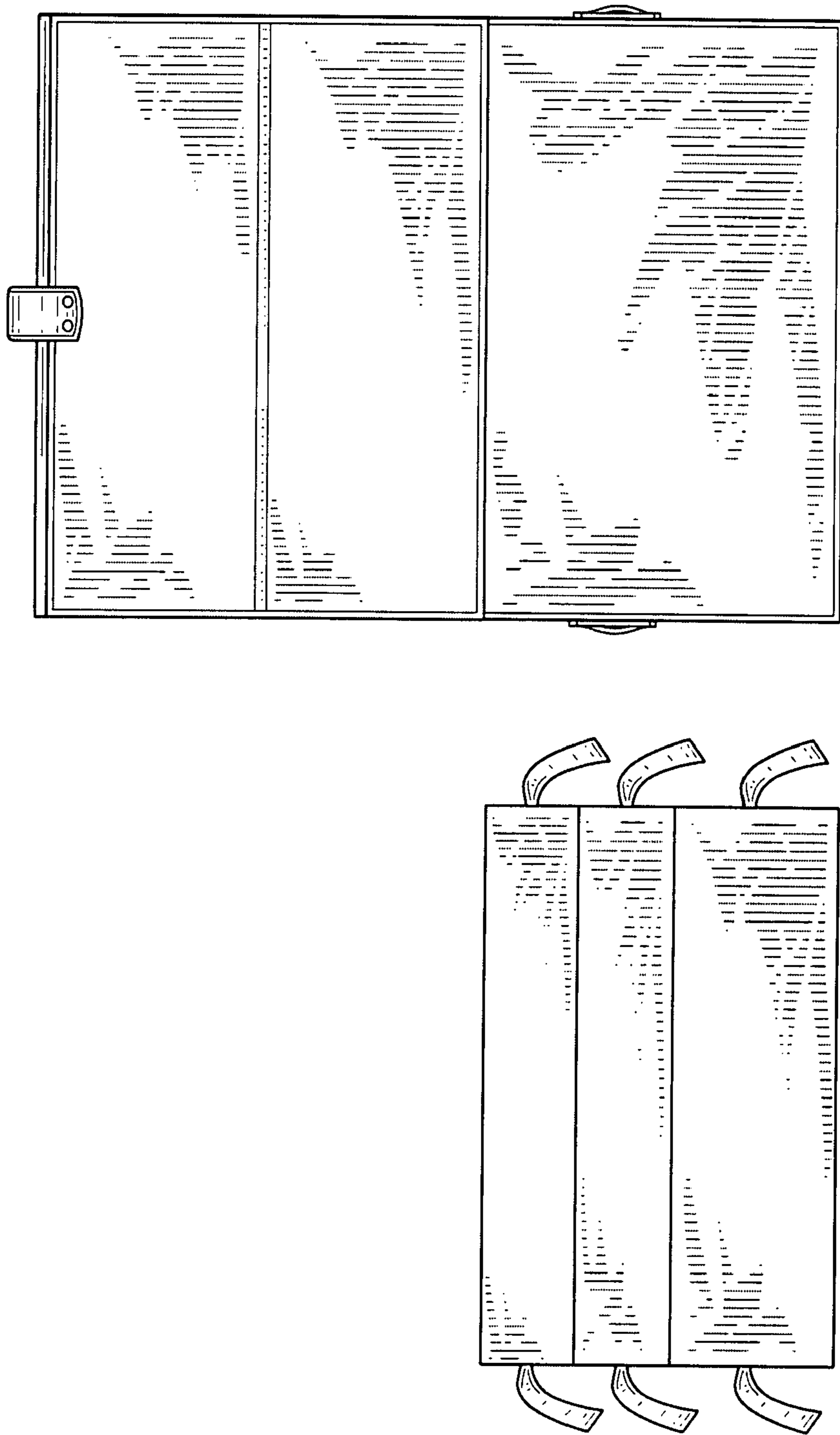

FIG. 10

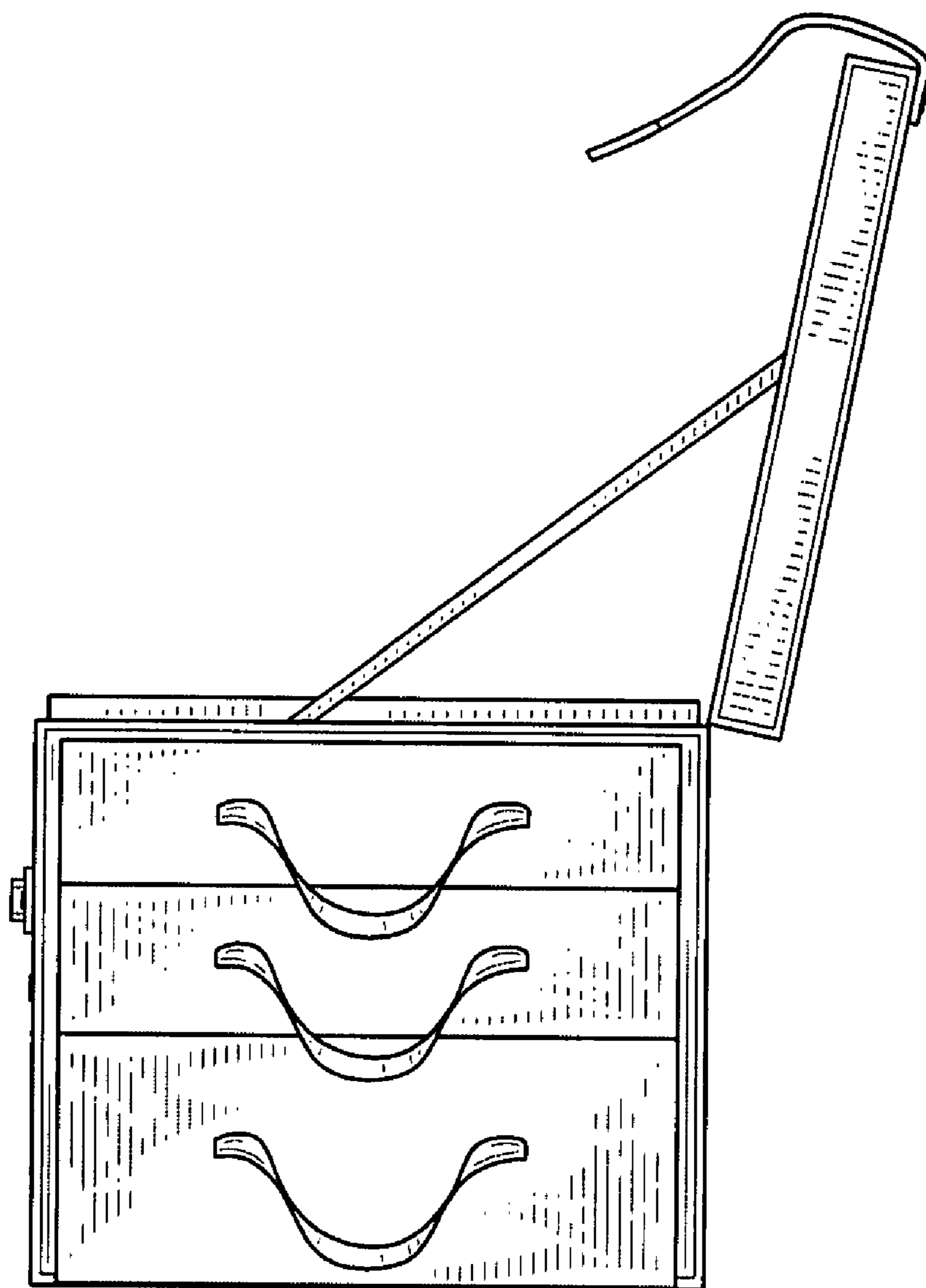

FIG. 11

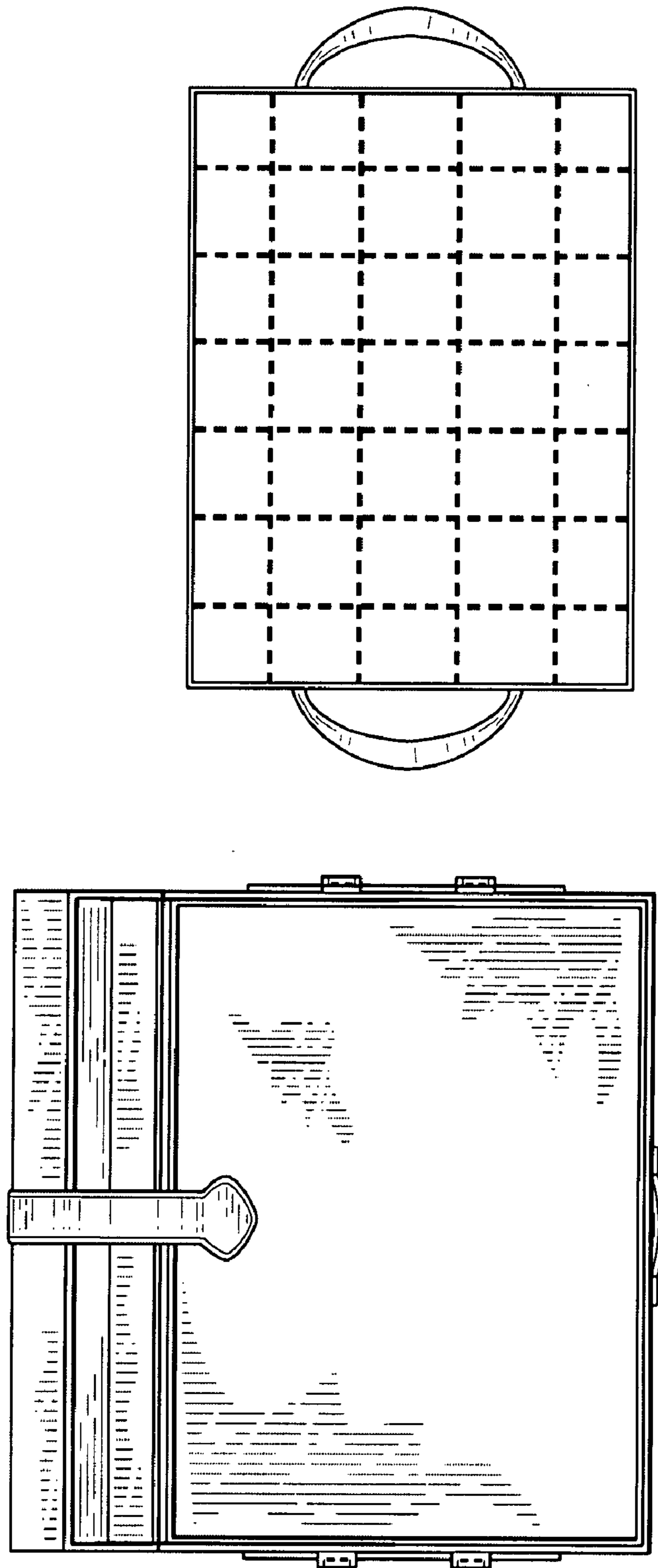

FIG. 12

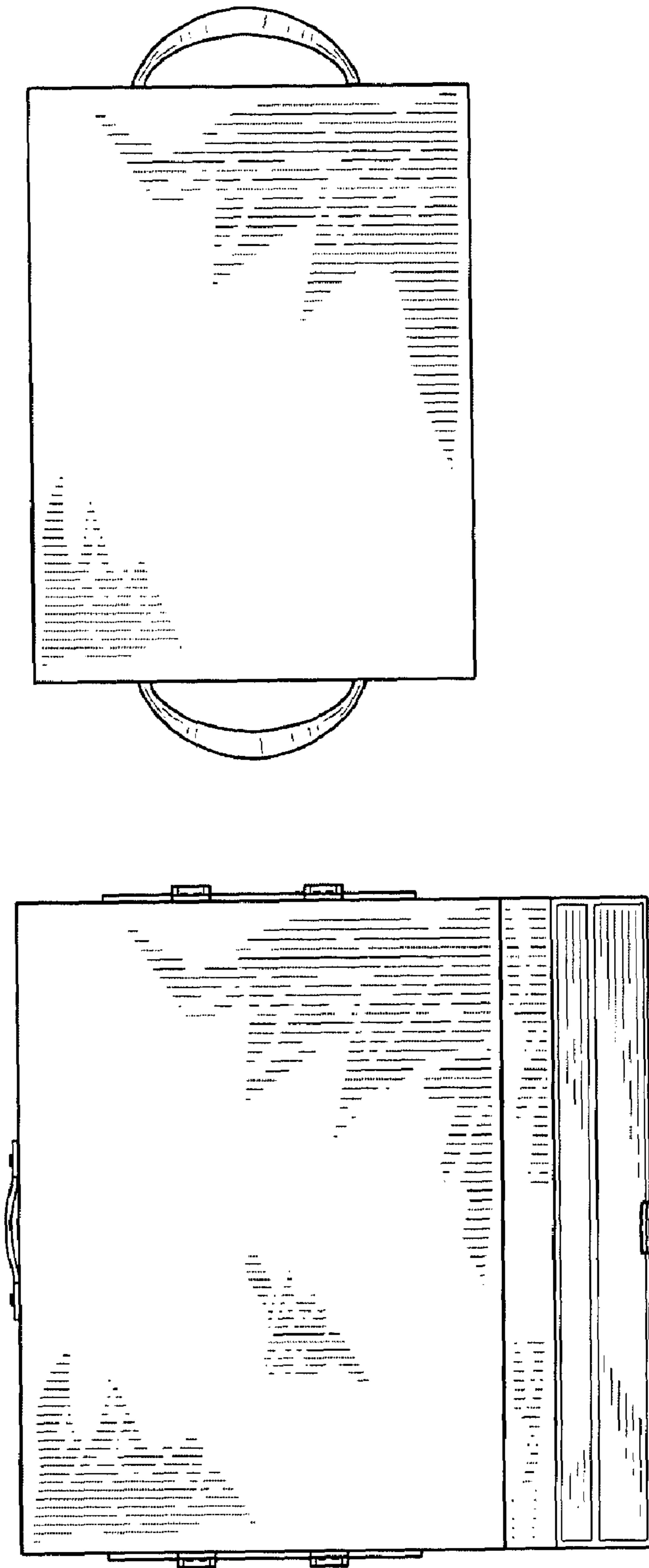

FIG. 13

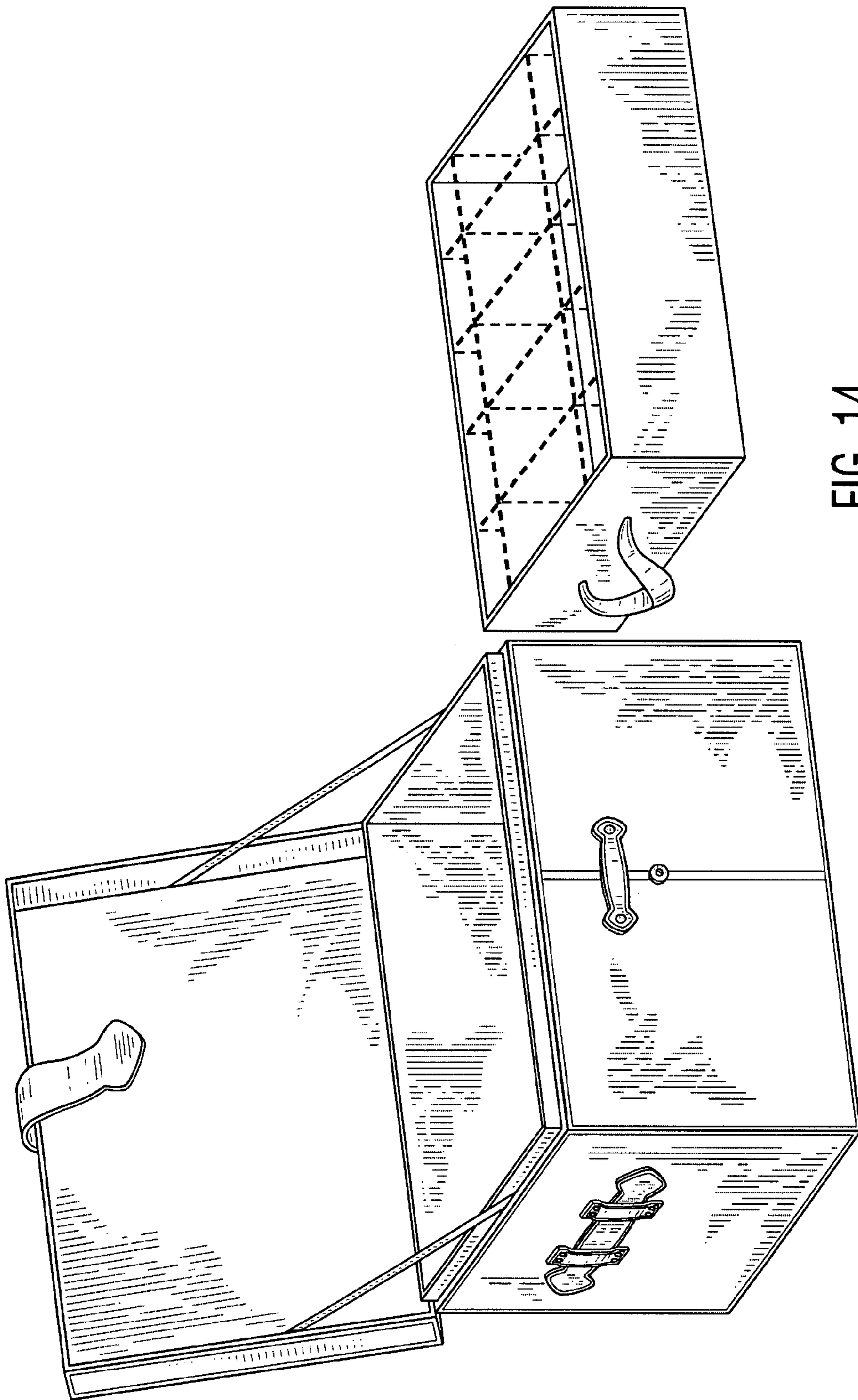

FIG. 14

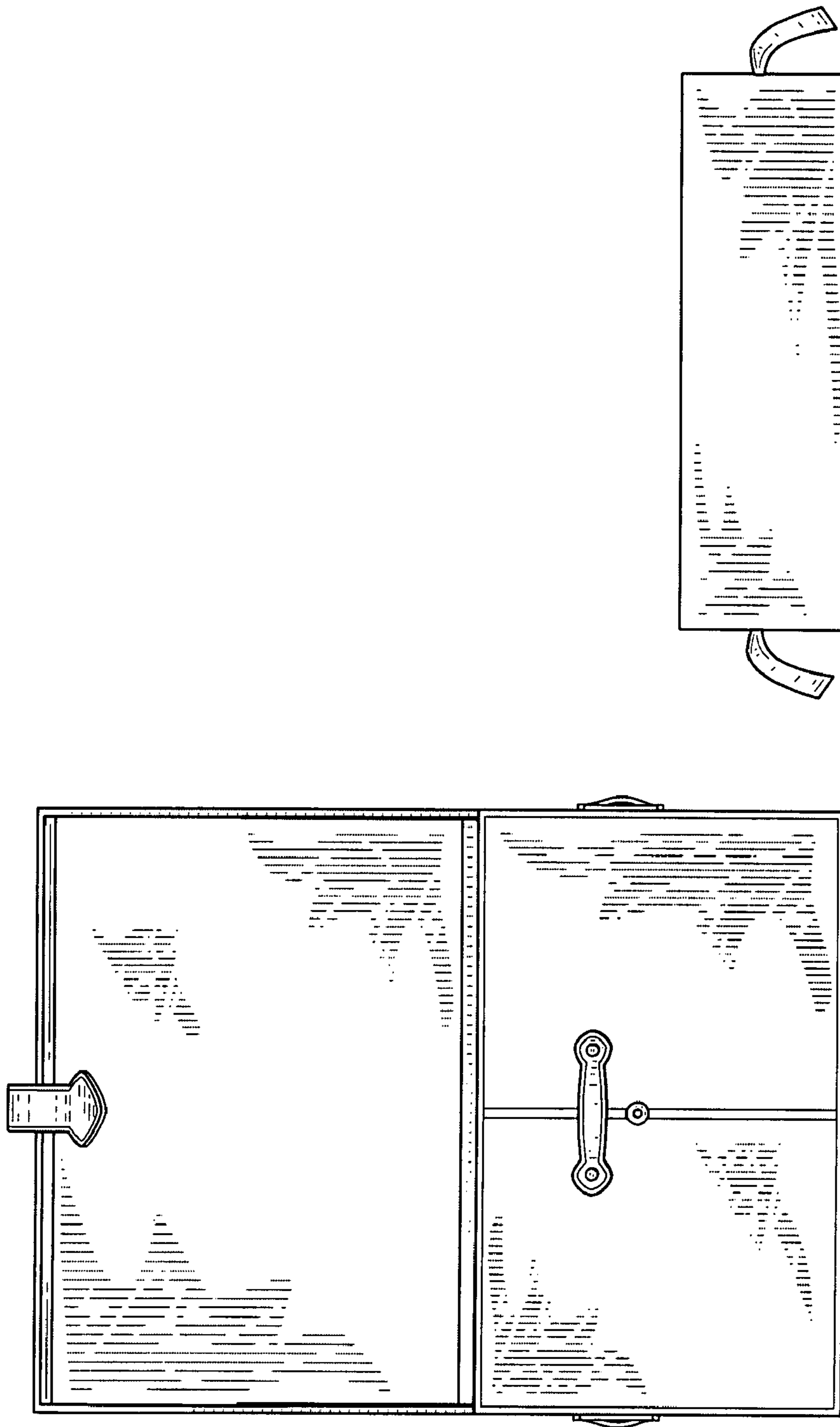

FIG. 15

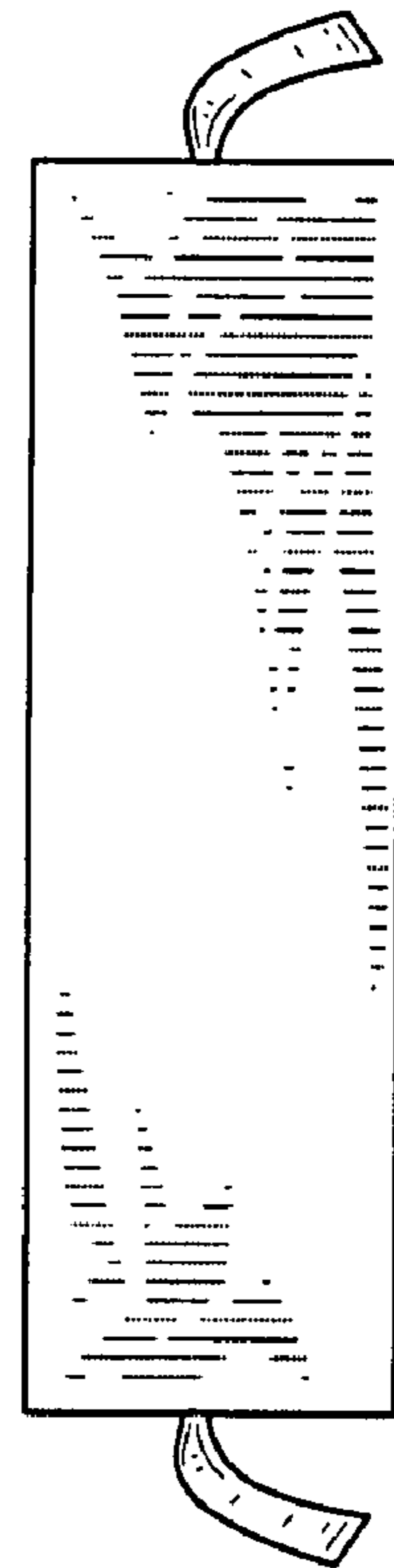

FIG. 16



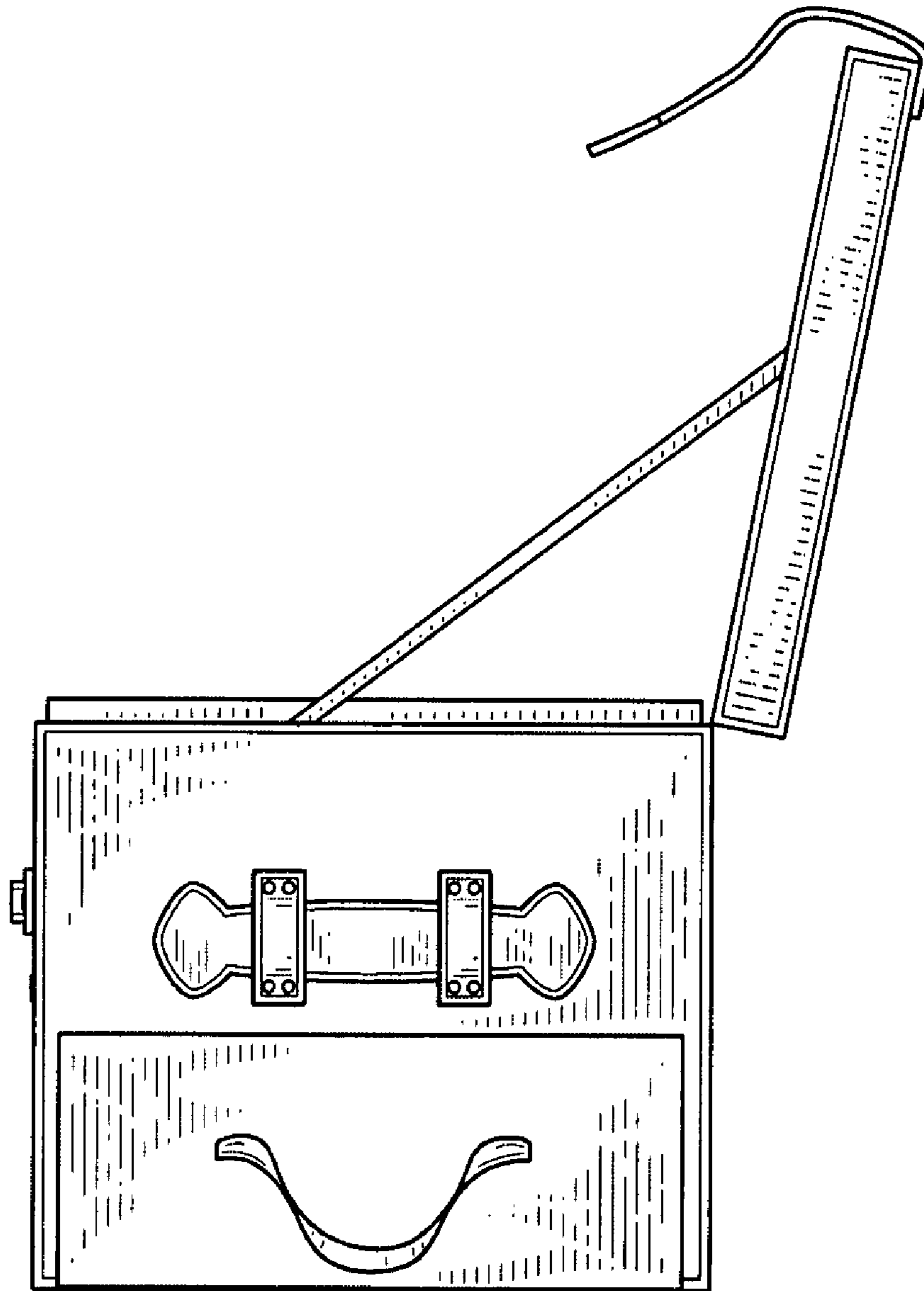

FIG. 17

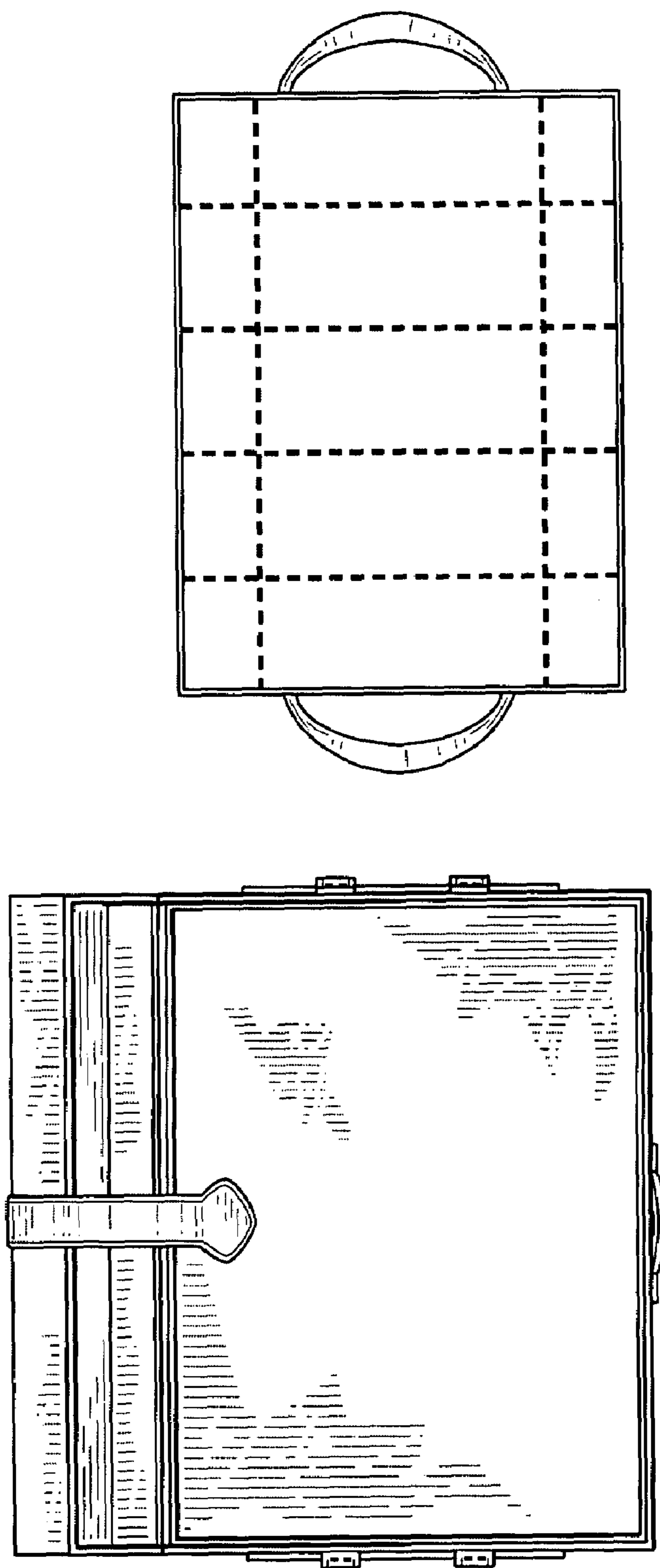

FIG. 18

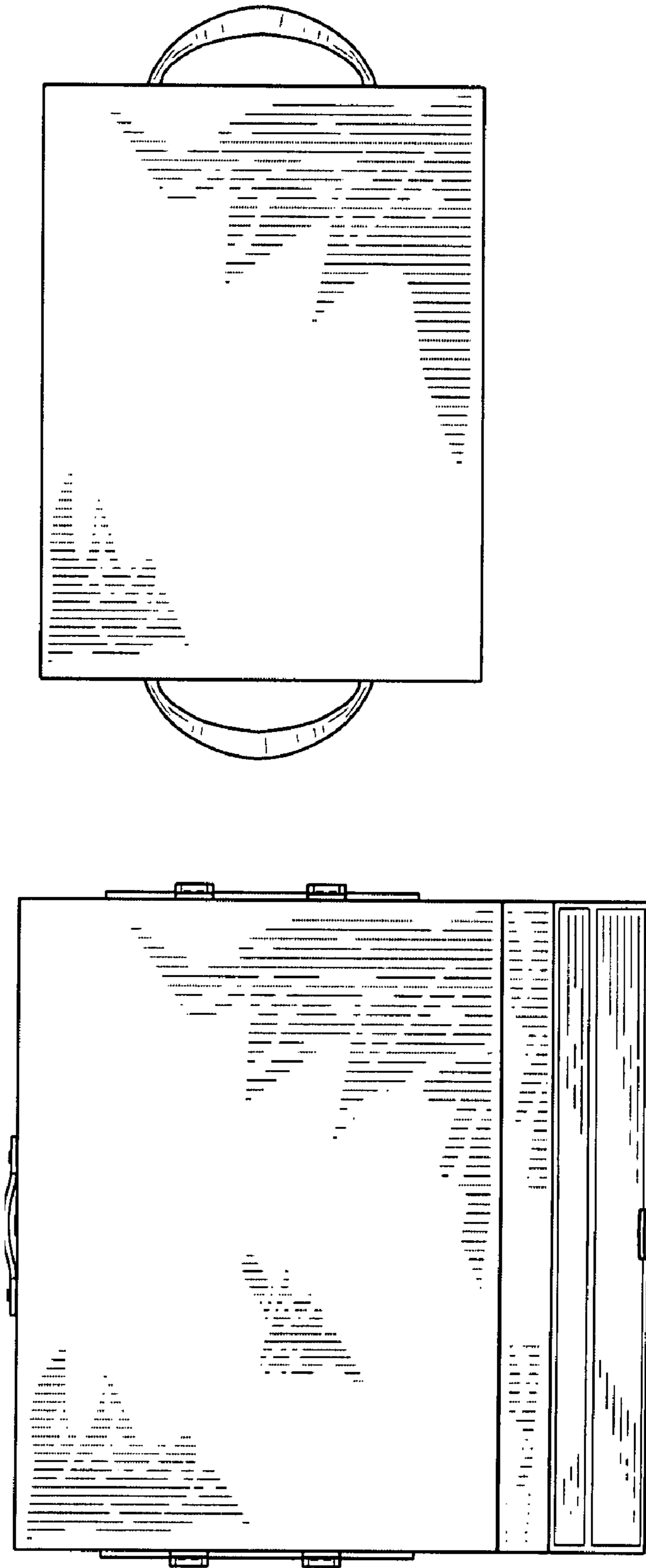

FIG. 19