



US00D577144S

(12) **United States Design Patent**  
**Benensohn**

(10) **Patent No.:** **US D577,144 S**

(45) **Date of Patent:** **\*\* Sep. 16, 2008**

(54) **UNDERCABINET LIGHTING FIXTURE**

D532,920 S \* 11/2006 Echito ..... D26/86  
2006/0262520 A1 \* 11/2006 Tress et al. .... 362/133

(76) Inventor: **Sanford H. Benensohn**, 28310 Avenue  
Crocker, Suite B, Valencia, CA (US)  
91355

\* cited by examiner

*Primary Examiner*—Clare E Heflin

(74) *Attorney, Agent, or Firm*—Michael A. Painter

(\*\*) Term: **14 Years**

(21) Appl. No.: **29/307,640**

(57) **CLAIM**

(22) Filed: **May 5, 2008**

The ornamental design for an undercabinet lighting fixture, as shown and described.

(51) **LOC (8) Cl.** ..... **26-05**

(52) **U.S. Cl.** ..... **D26/72**

(58) **Field of Classification Search** ..... D26/1,  
D26/2, 24, 76–78, 80, 86, 35, 36, 72; D13/182;  
362/100, 127, 133, 240, 605, 612, 613, 640,  
362/646, 648

See application file for complete search history.

**DESCRIPTION**

FIG. 1 is a front perspective view of an undercabinet lighting fixture illustrating my new design;

FIG. 2 is a front elevation view thereof;

FIG. 3 is a right side elevation view thereof, the left side elevation view being a mirror image thereof;

FIG. 4 is a rear elevation view thereof;

FIG. 5 is a top plan view; and,

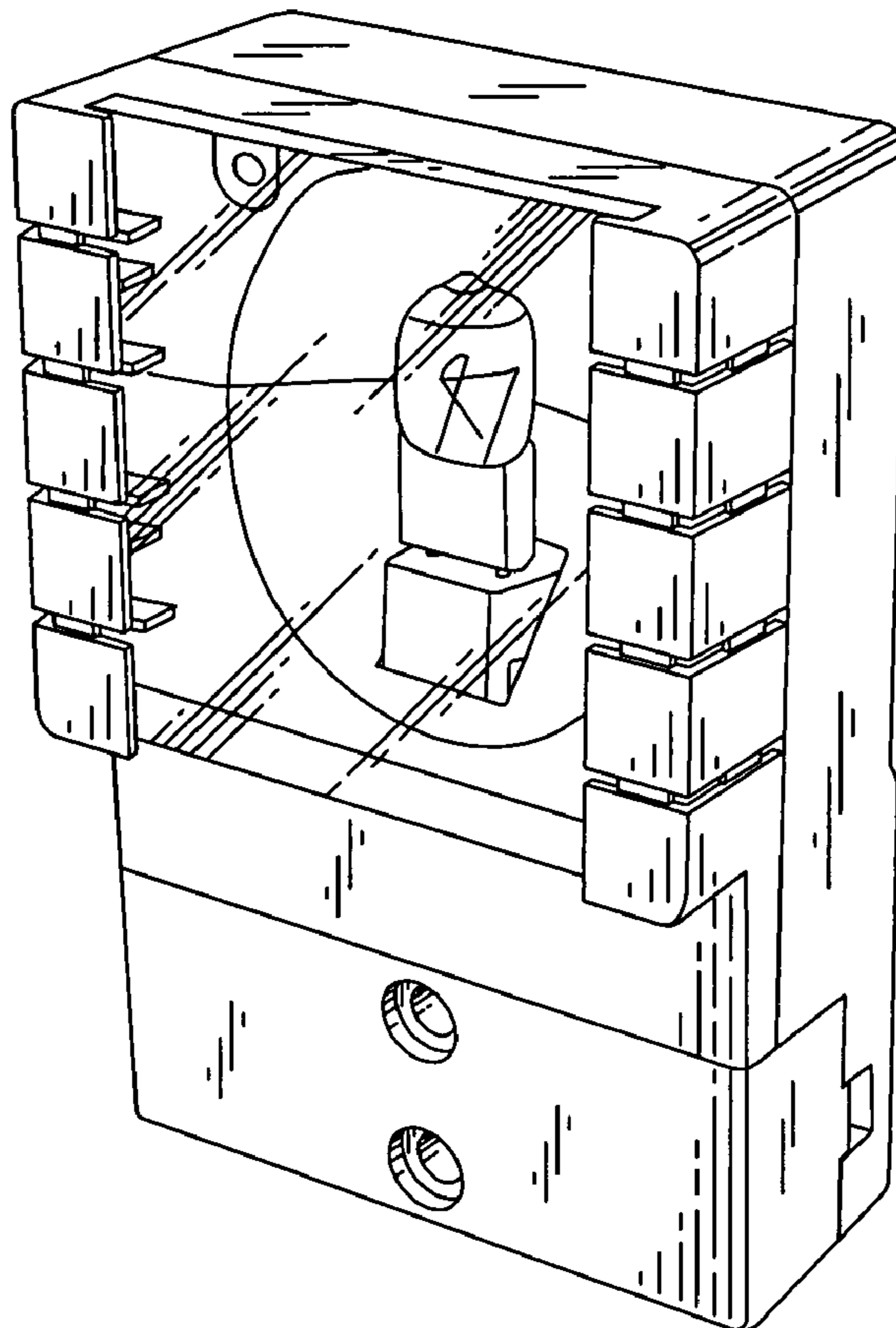
FIG. 6 is a bottom plan view thereof.

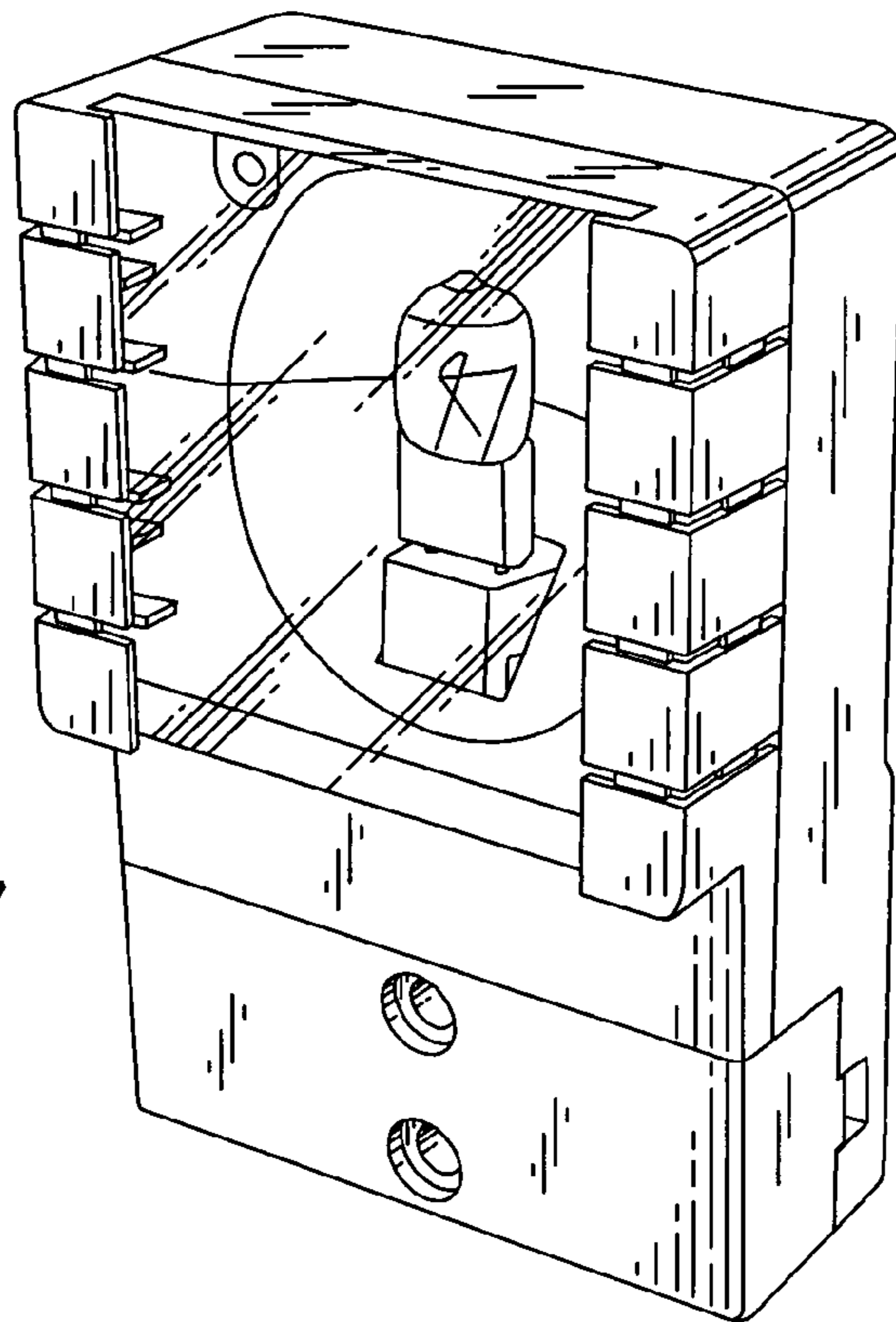
(56) **References Cited**

**U.S. PATENT DOCUMENTS**

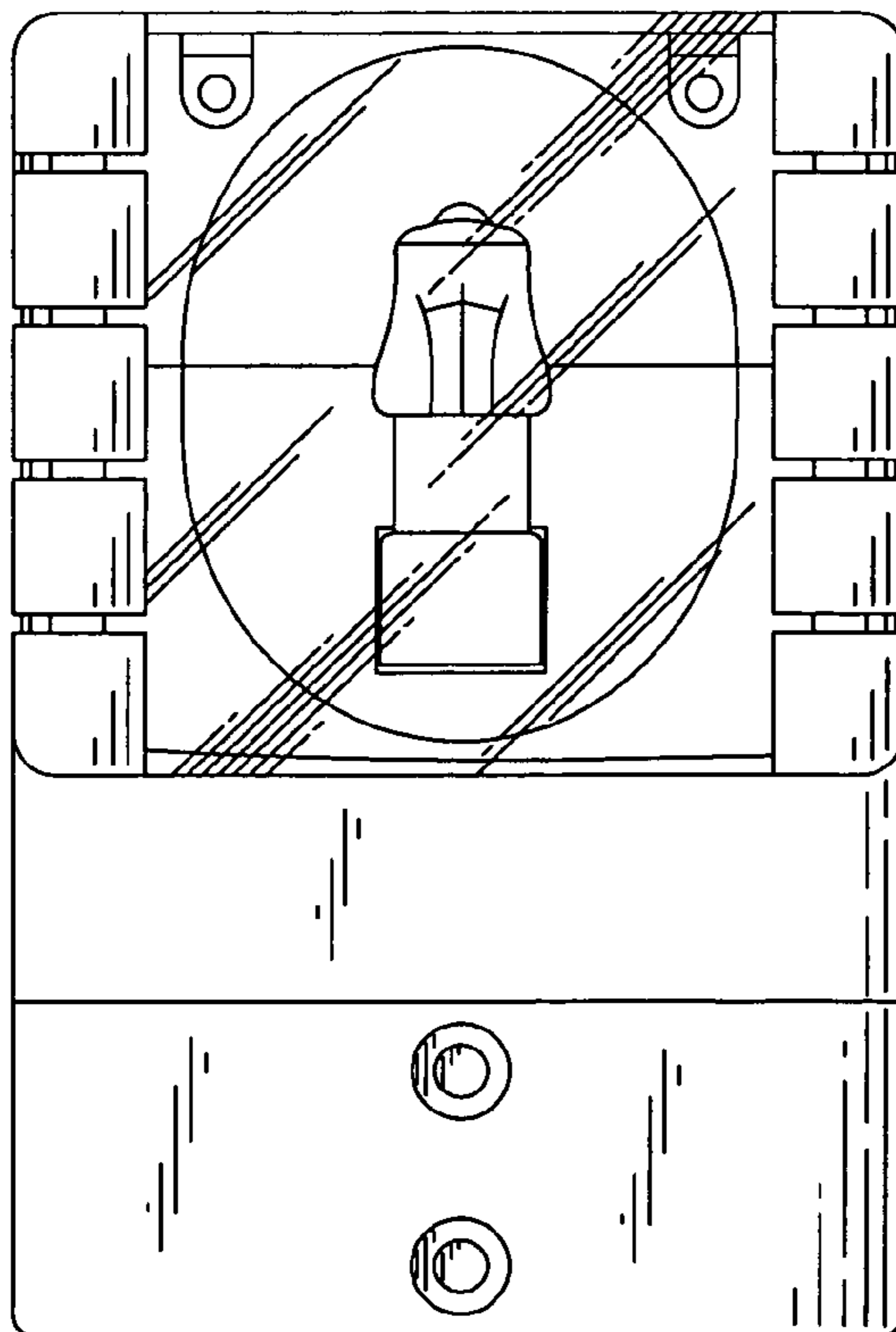
D265,132 S \* 6/1982 Brooks ..... D26/24  
D272,475 S \* 1/1984 Yahraus ..... D26/24  
D315,962 S \* 4/1991 Lavinsky et al. .... D26/24

**1 Claim, 2 Drawing Sheets**

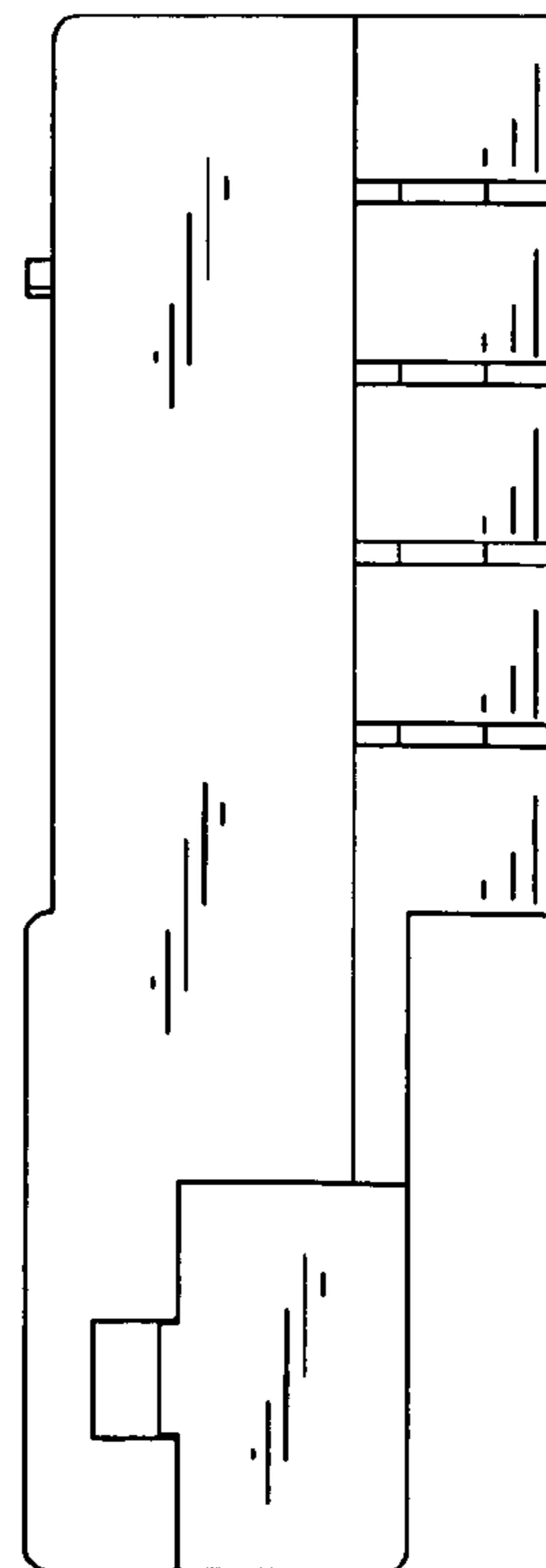




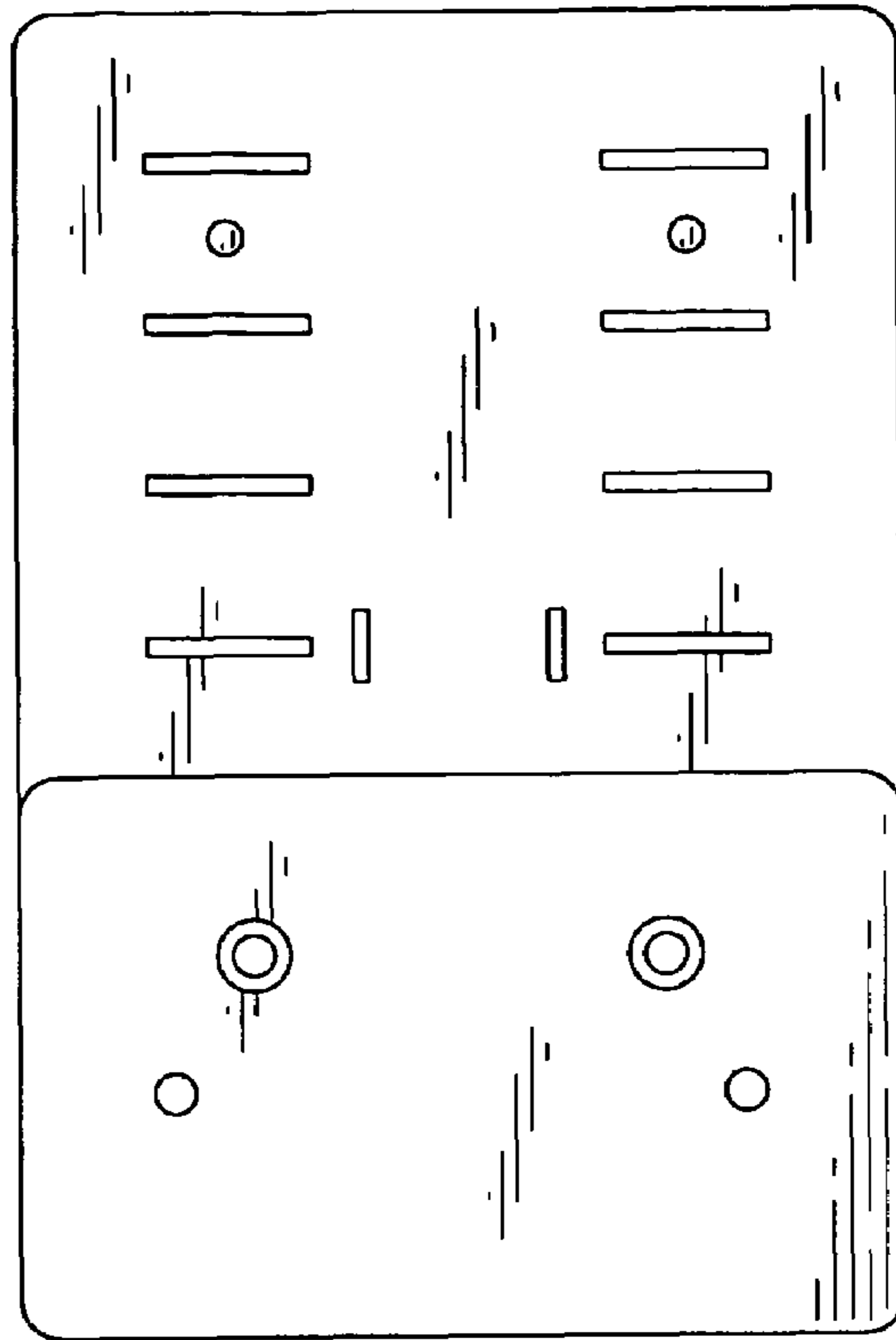
*Fig. 1*



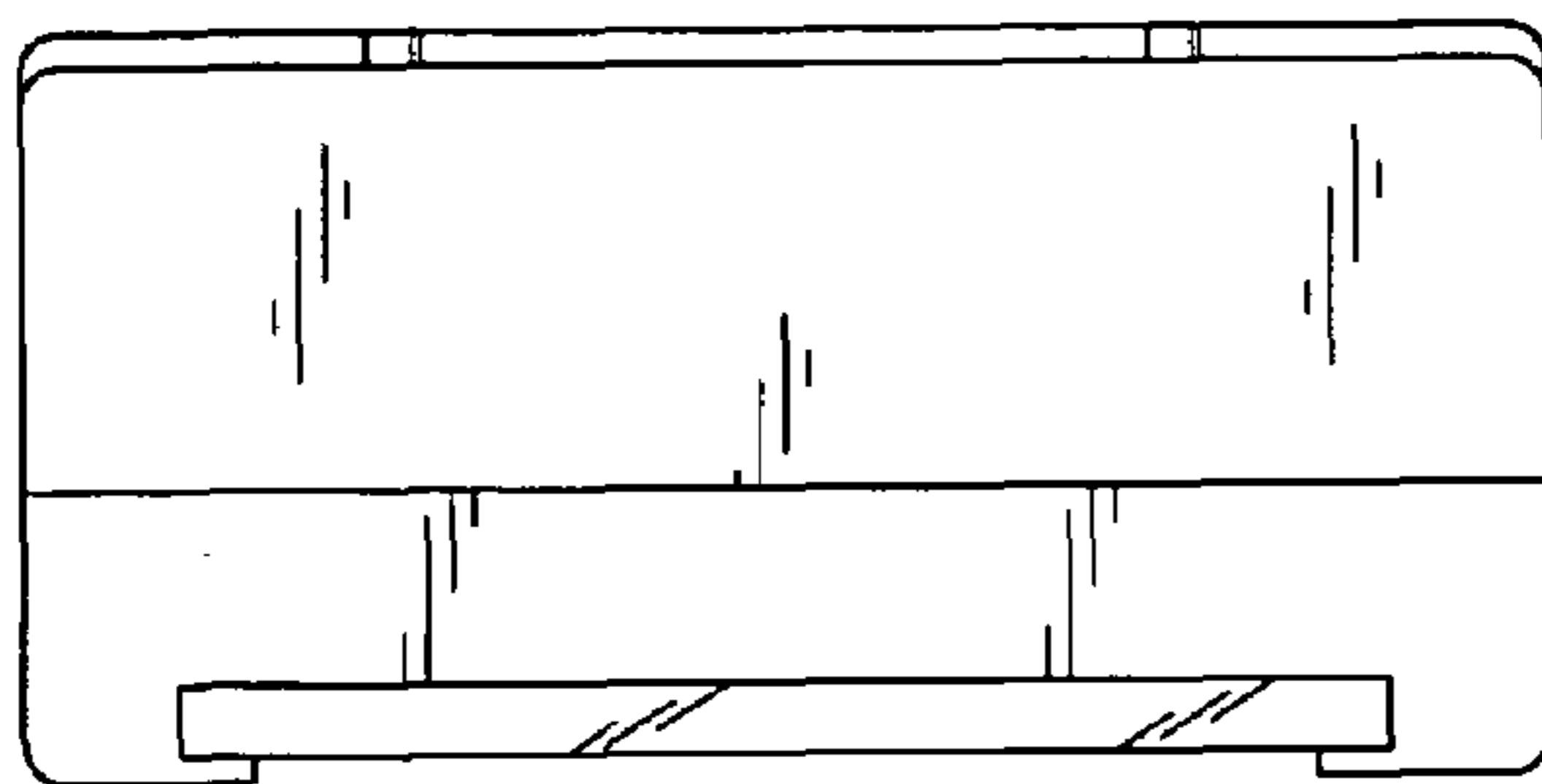
*Fig. 2*



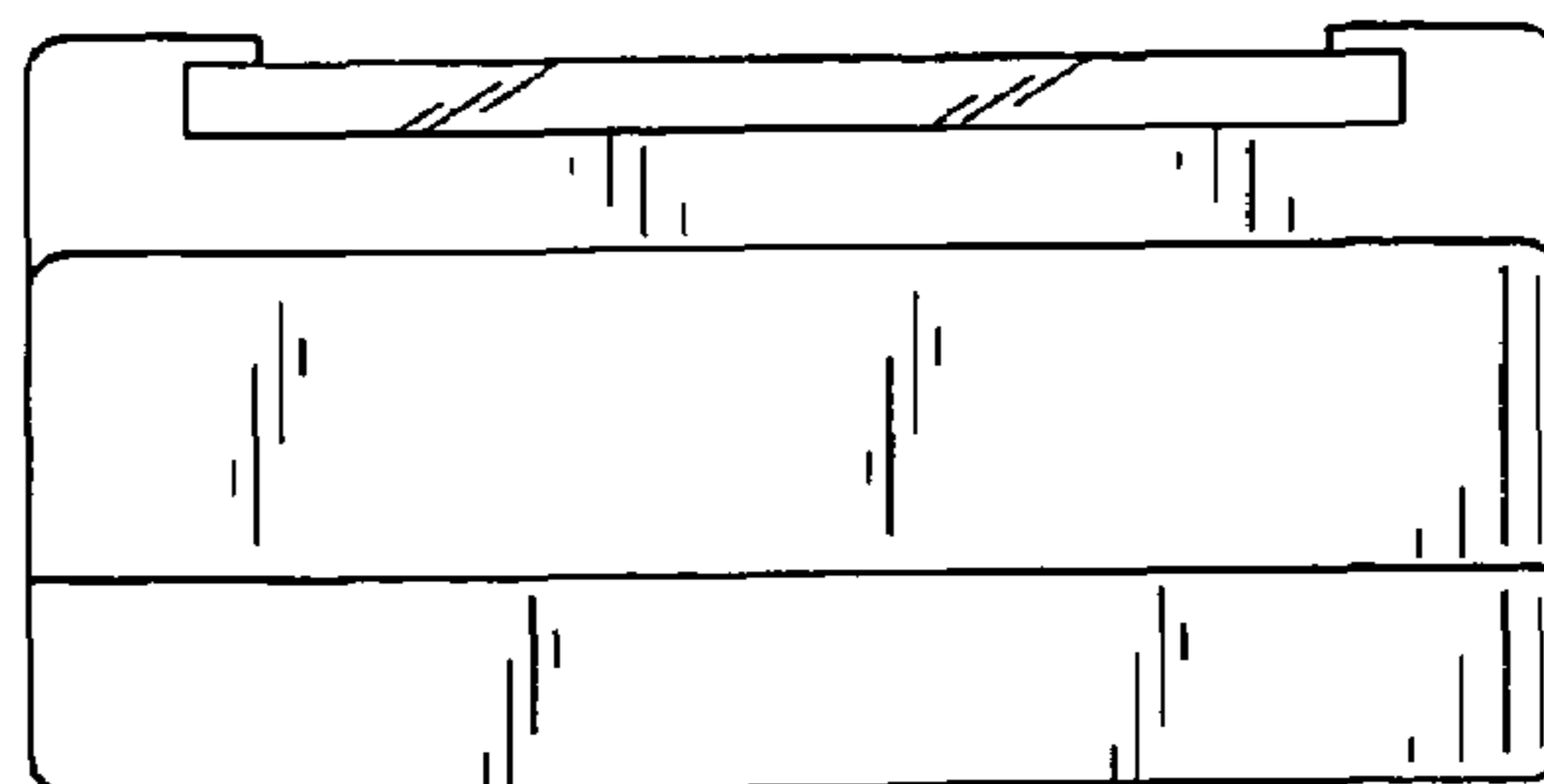
*Fig. 3*



*Fig. 4*



*Fig. 5*



*Fig. 6*