



US00D577115S

(12) **United States Design Patent**  
**Lui**

(10) **Patent No.:** **US D577,115 S**

(45) **Date of Patent:** **\*\* Sep. 16, 2008**

(54) **FAN HOUSING**

(75) Inventor: **Wing Kit Lui**, Kowloon (HK)

(73) Assignee: **Eric Beare Associates Ltd.**, Kowloon (HK)

(\*\*) Term: **14 Years**

(21) Appl. No.: **29/235,067**

(22) Filed: **Jul. 27, 2005**

(51) **LOC (8) Cl.** ..... **23-04**

(52) **U.S. Cl.** ..... **D23/411**

(58) **Field of Classification Search** ..... D23/378,  
D23/380, 381, 382, 411, 413, 335-336, 379,  
D23/370; 416/5, 246, 247 R, 244 R, 63  
See application file for complete search history.

(56) **References Cited**

**U.S. PATENT DOCUMENTS**

D313,275 S *	12/1990	Aida .....	D23/370
D365,393 S *	12/1995	Geun .....	D23/382
D387,422 S *	12/1997	Radtke et al. ....	D23/328
D394,500 S *	5/1998	Feer .....	D23/332
D529,166 S *	9/2006	Geringer .....	D23/379
D544,078 S *	6/2007	Geringer .....	D23/328

\* cited by examiner

*Primary Examiner*—Lisa Lichtenstein

(74) *Attorney, Agent, or Firm*—Kenneth H. Ohriner; Perkins Coie LLP

(57) **CLAIM**

The ornamental design for a fan housing, as shown and described.

**DESCRIPTION**

FIGS. 1-8 show a first embodiment of my new and ornamental design for a fan housing.

FIG. 1 is a front and right side perspective view.

FIG. 2 is a back and left side perspective view.

FIG. 3 is a front view.

FIG. 4 is a right side view.

FIG. 5 is a left side view.

FIG. 6 is a back view.

FIG. 7 is a top view.

FIG. 8 is a bottom view.

FIG. 9 is a front and right side perspective view.

FIG. 10 is a back and left side perspective view.

FIG. 11 is a front view.

FIG. 12 is a right side view.

FIG. 13 is a left side view.

FIG. 14 is a back view.

FIG. 15 is a top view; and,

FIG. 16 is a bottom view.

The broken line showing of the fan hub and blades is included for the purpose of illustrating environmental structure and forms no part of the claimed design.

**1 Claim, 4 Drawing Sheets**

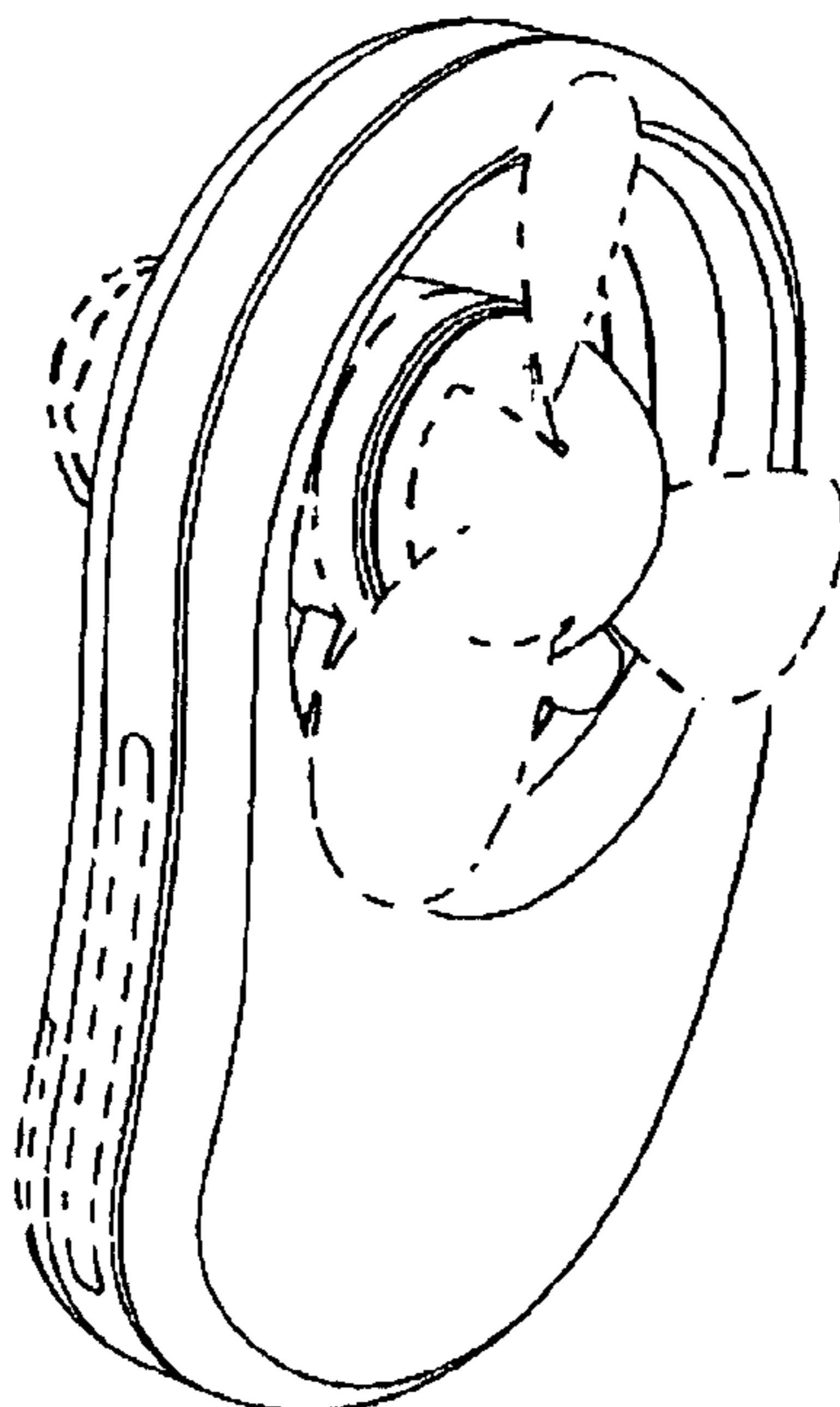

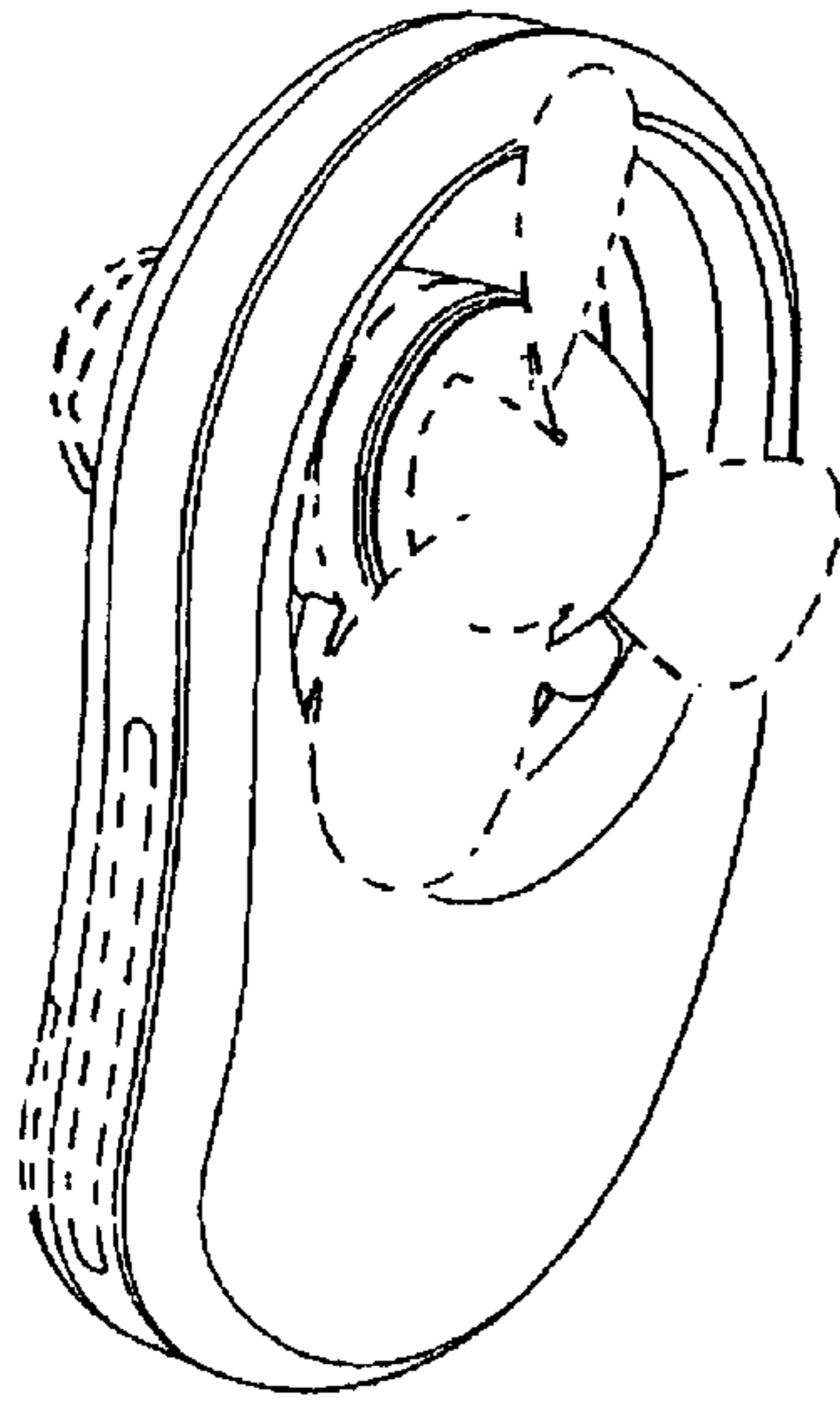

FIG 1

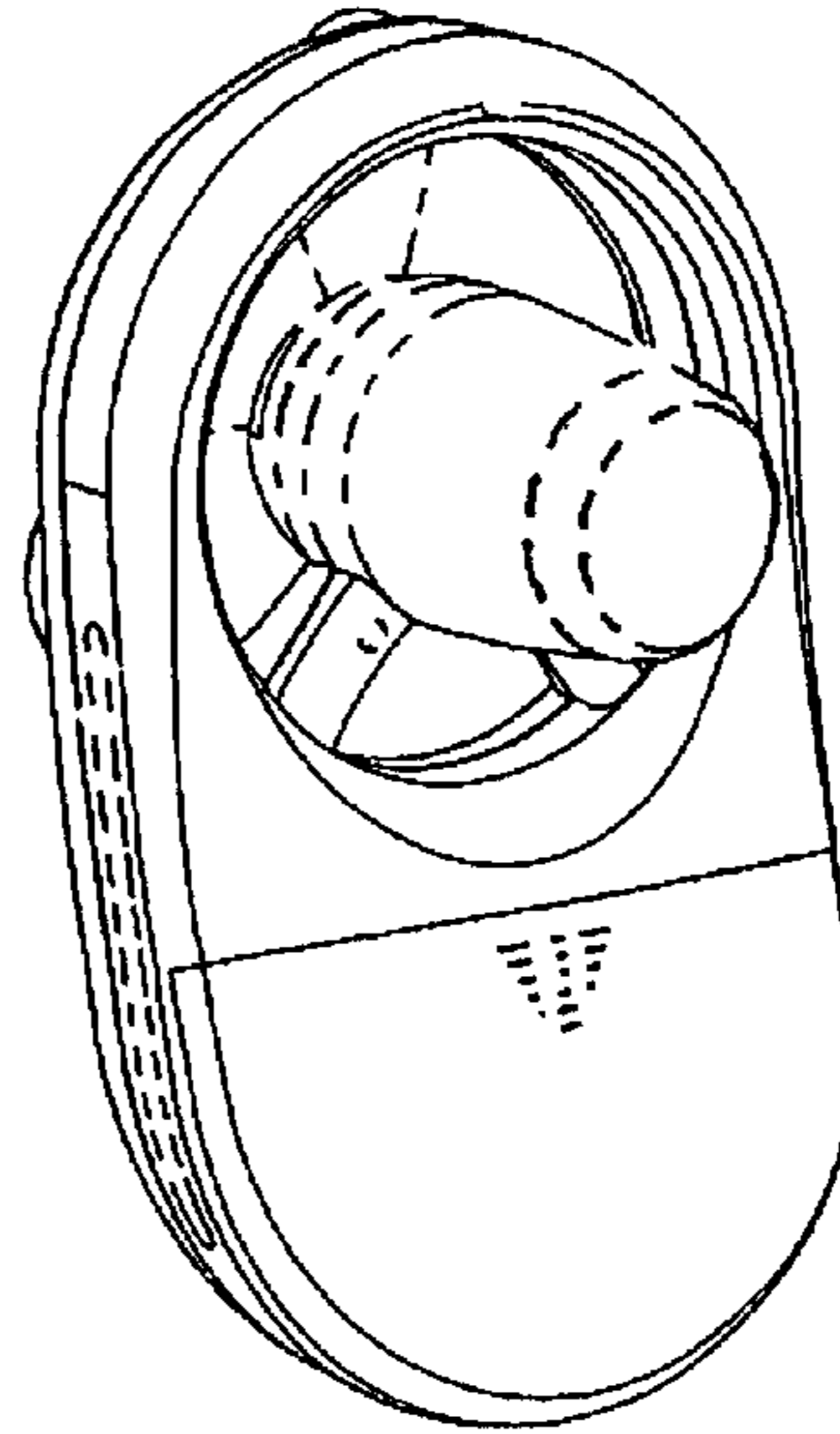

FIG 2

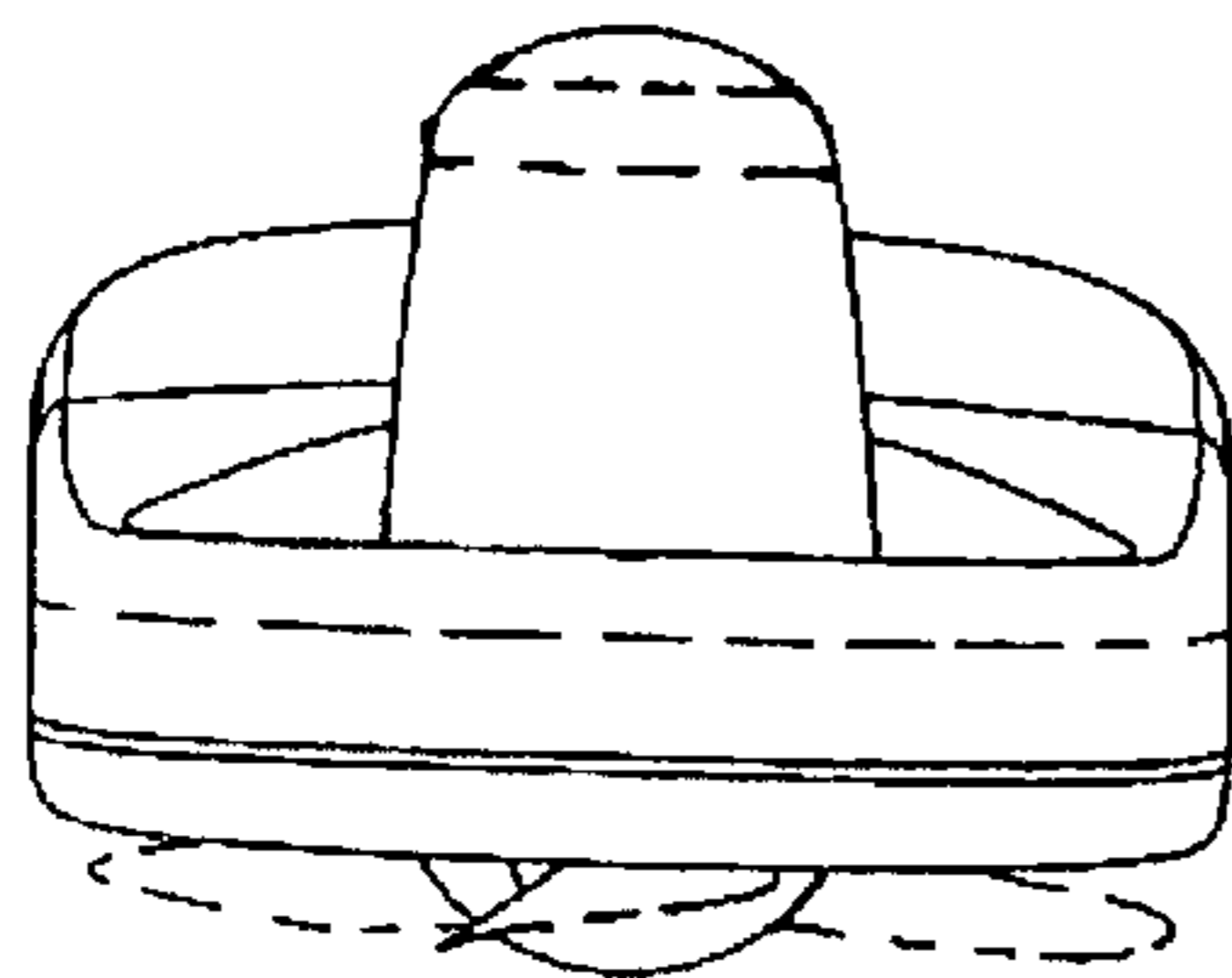

FIG 7

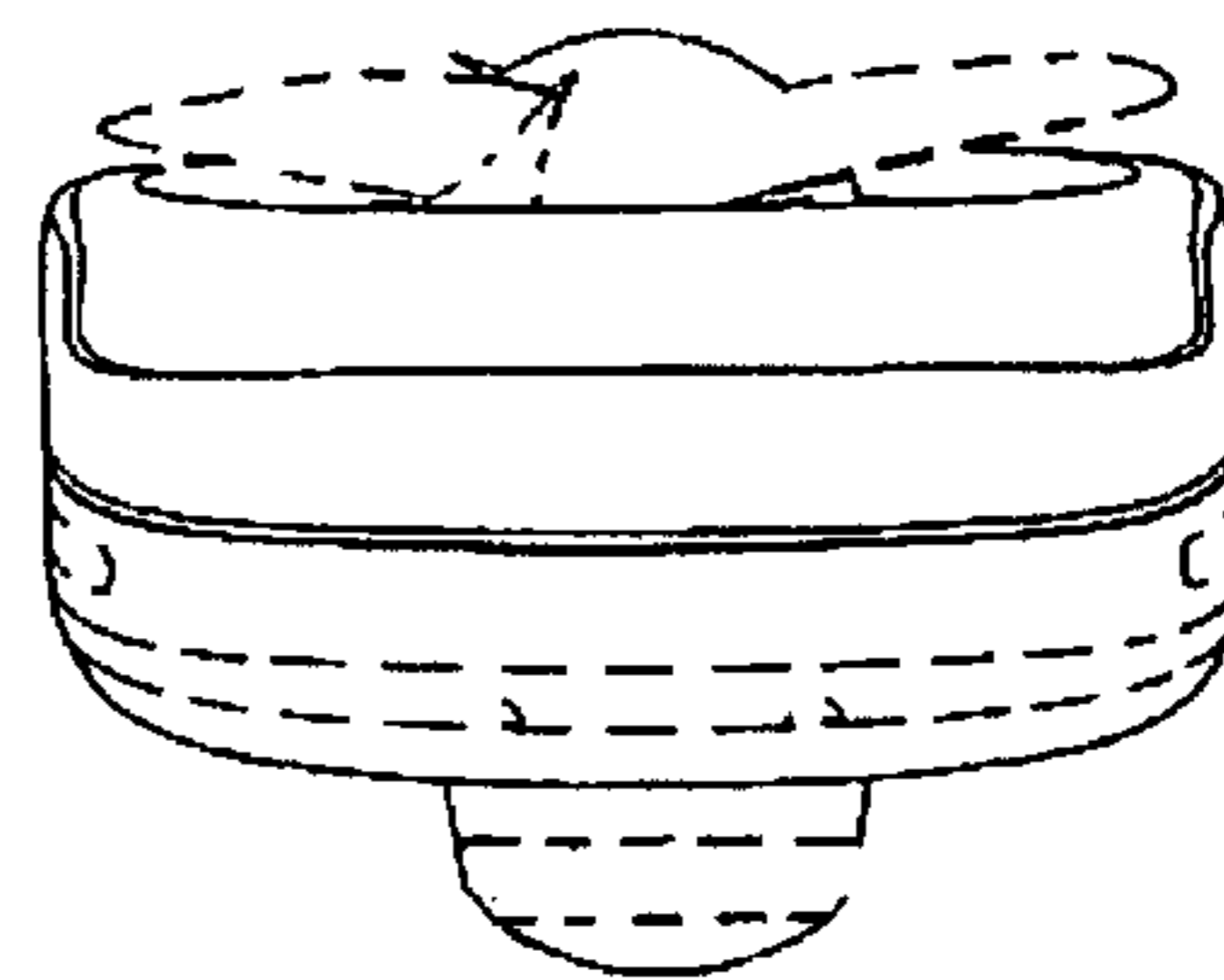

FIG 8

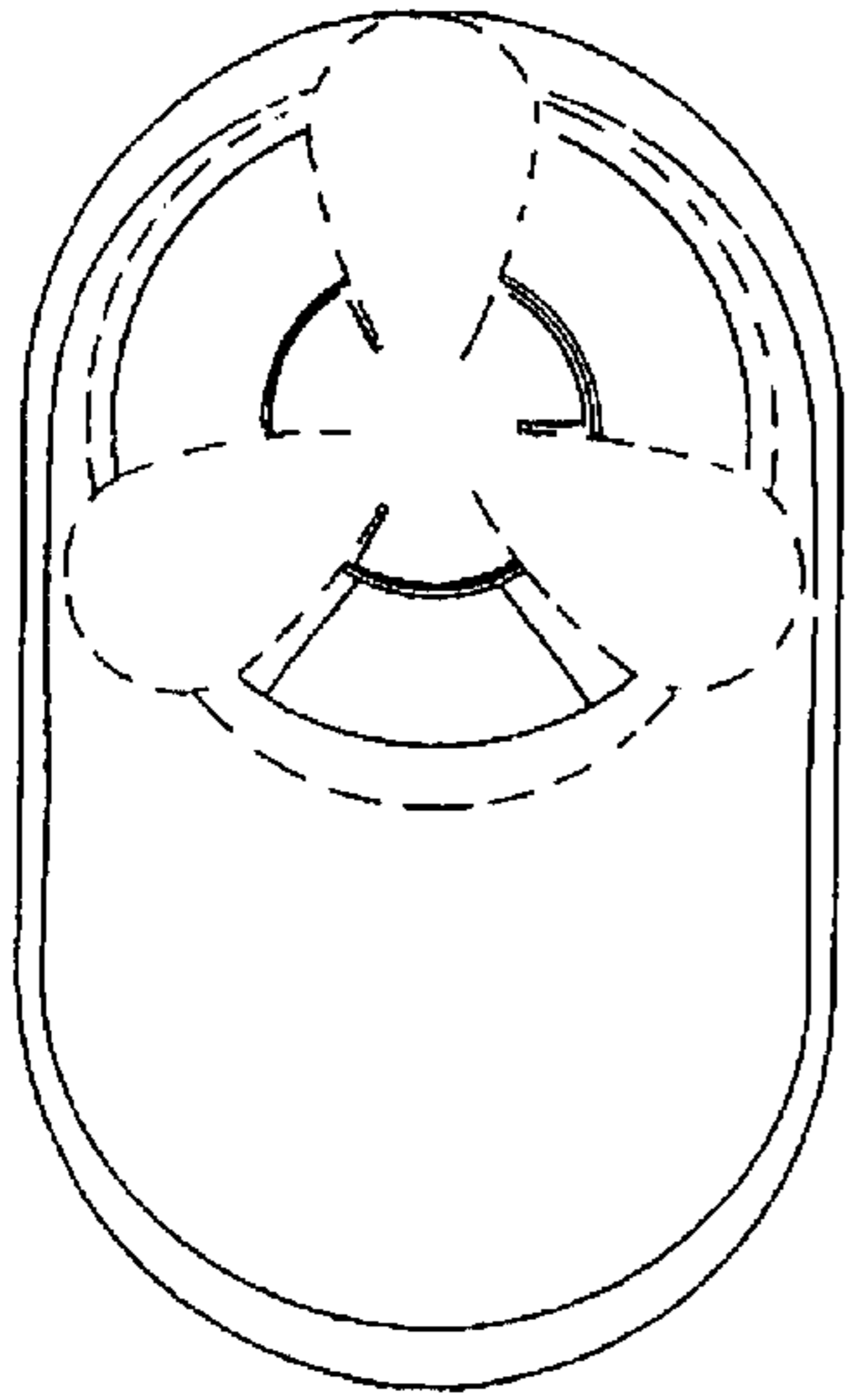

FIG 3

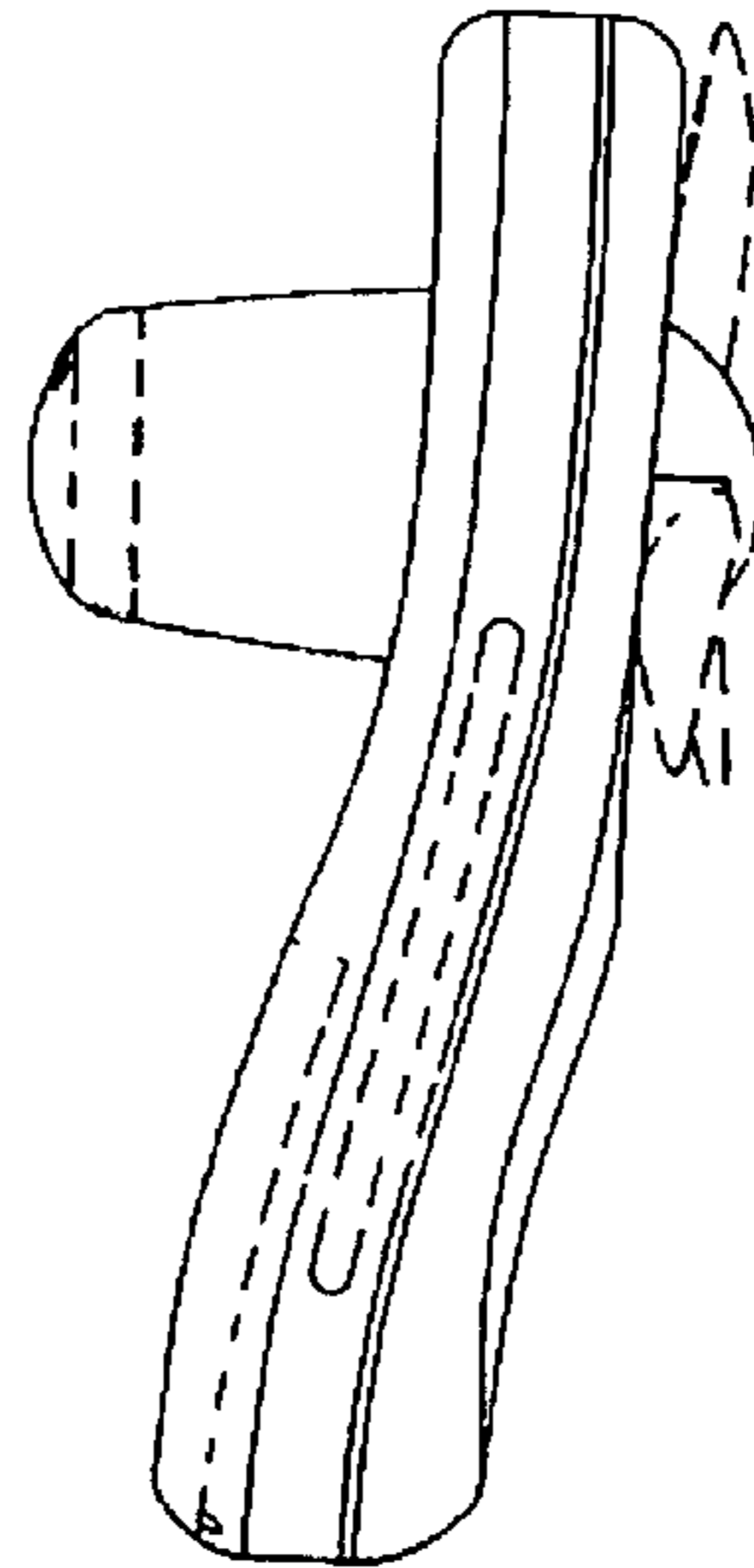

FIG 4

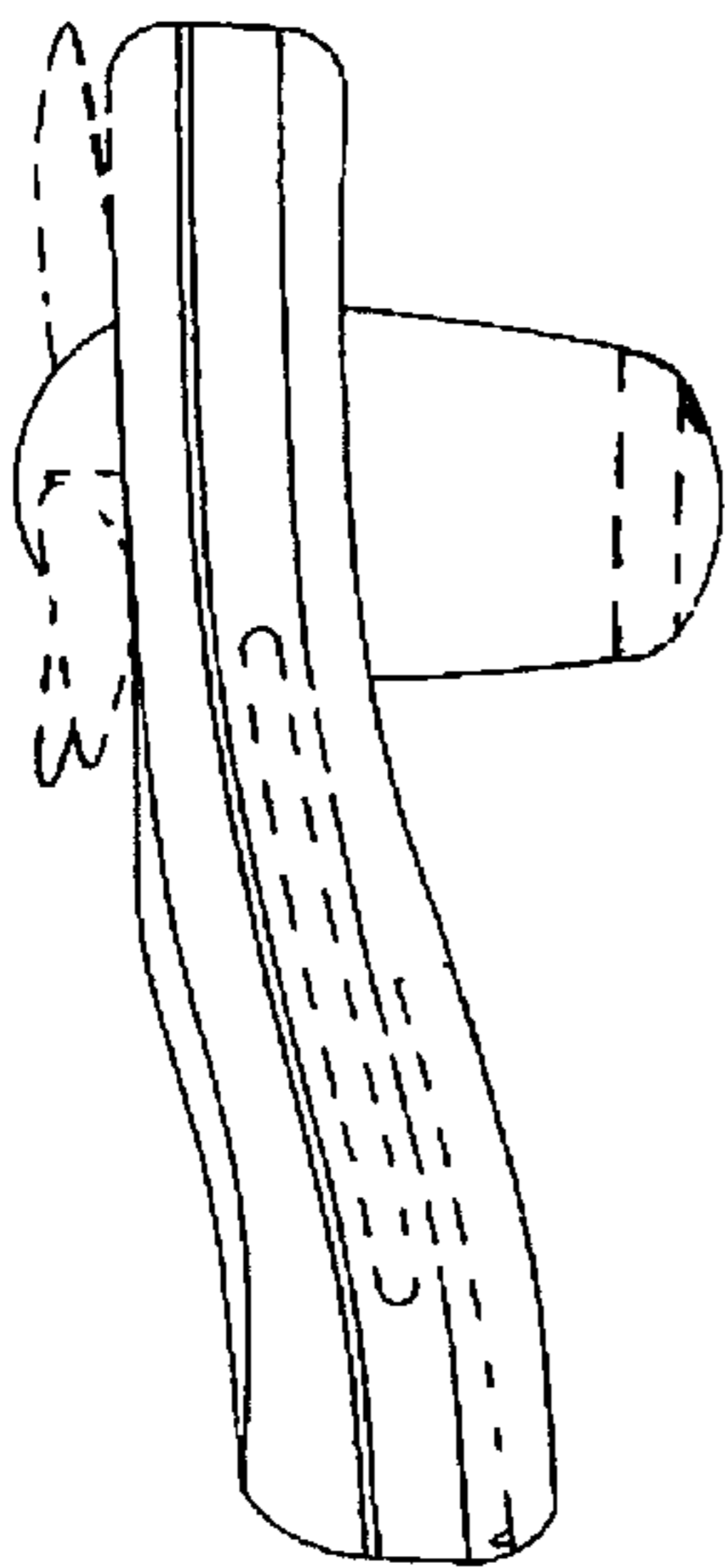

FIG 5

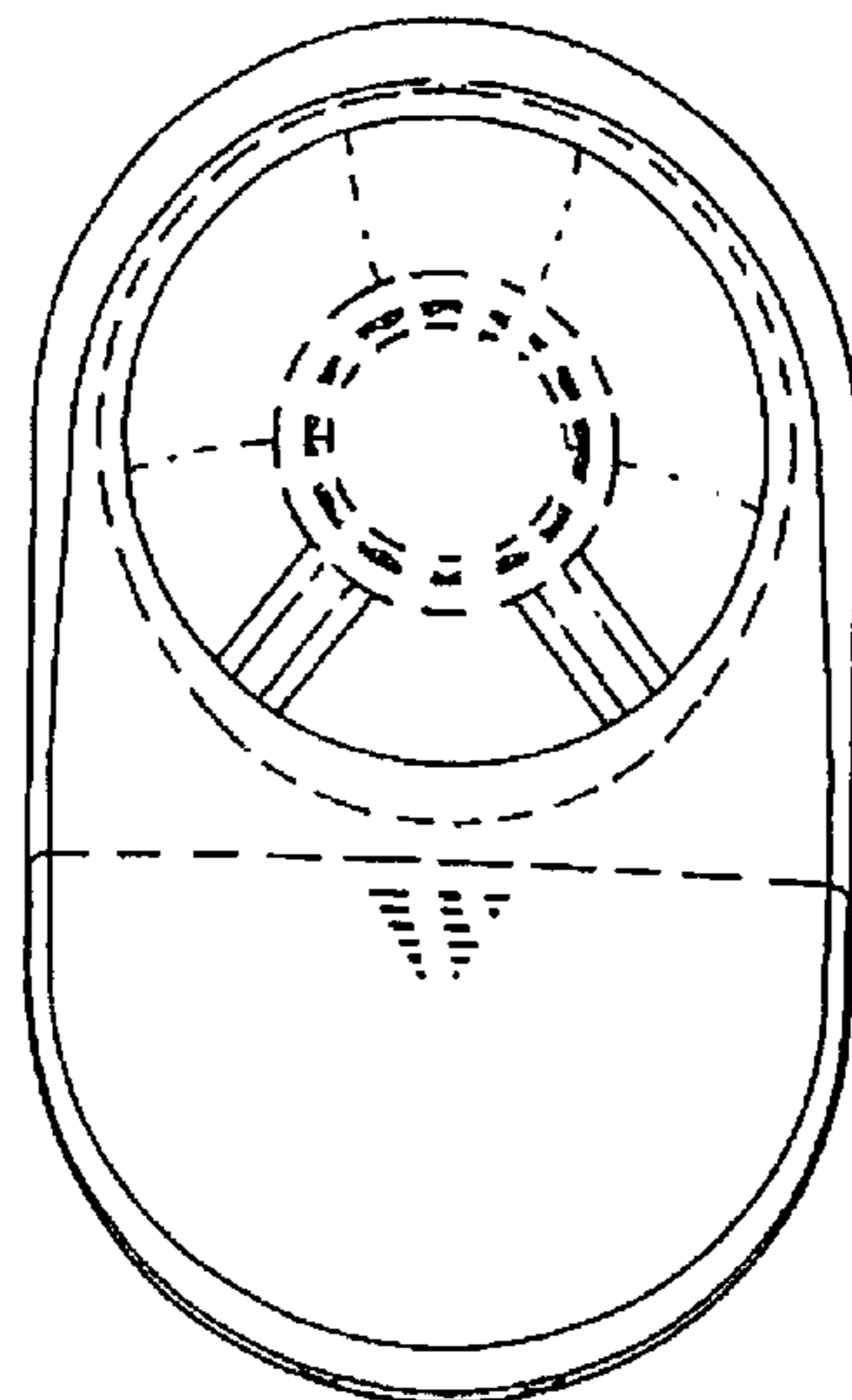

FIG 6

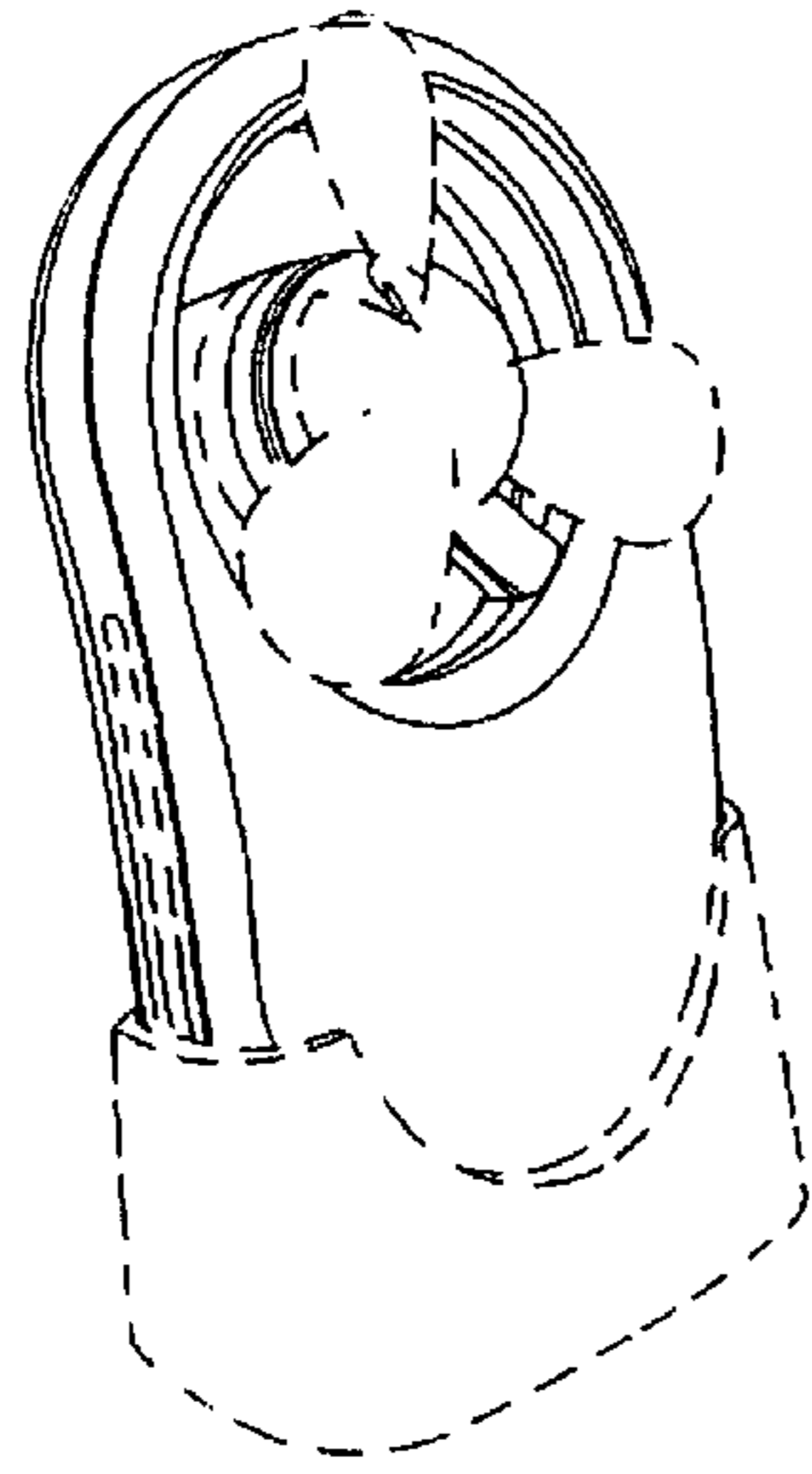

FIG 9

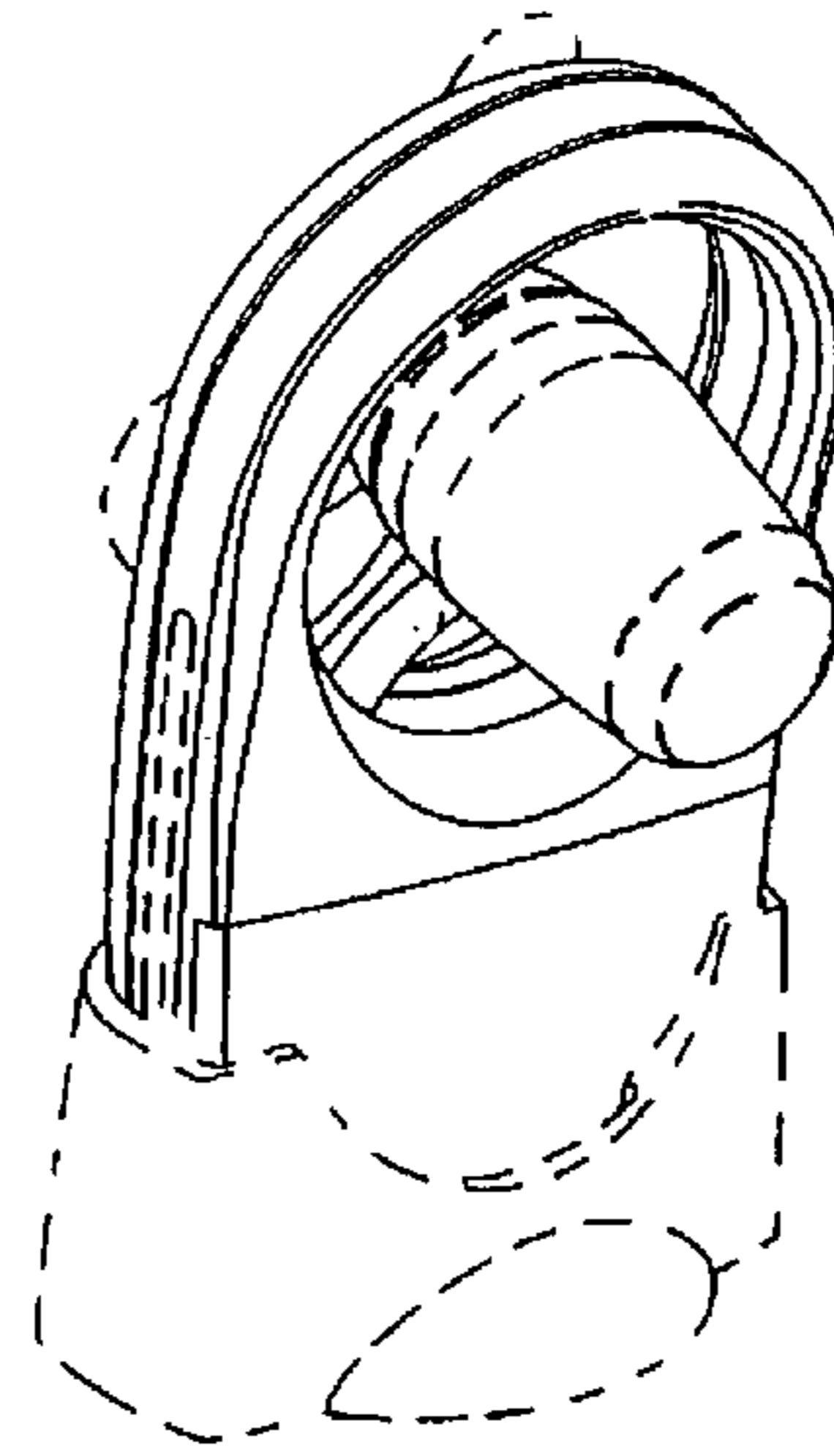

FIG 10

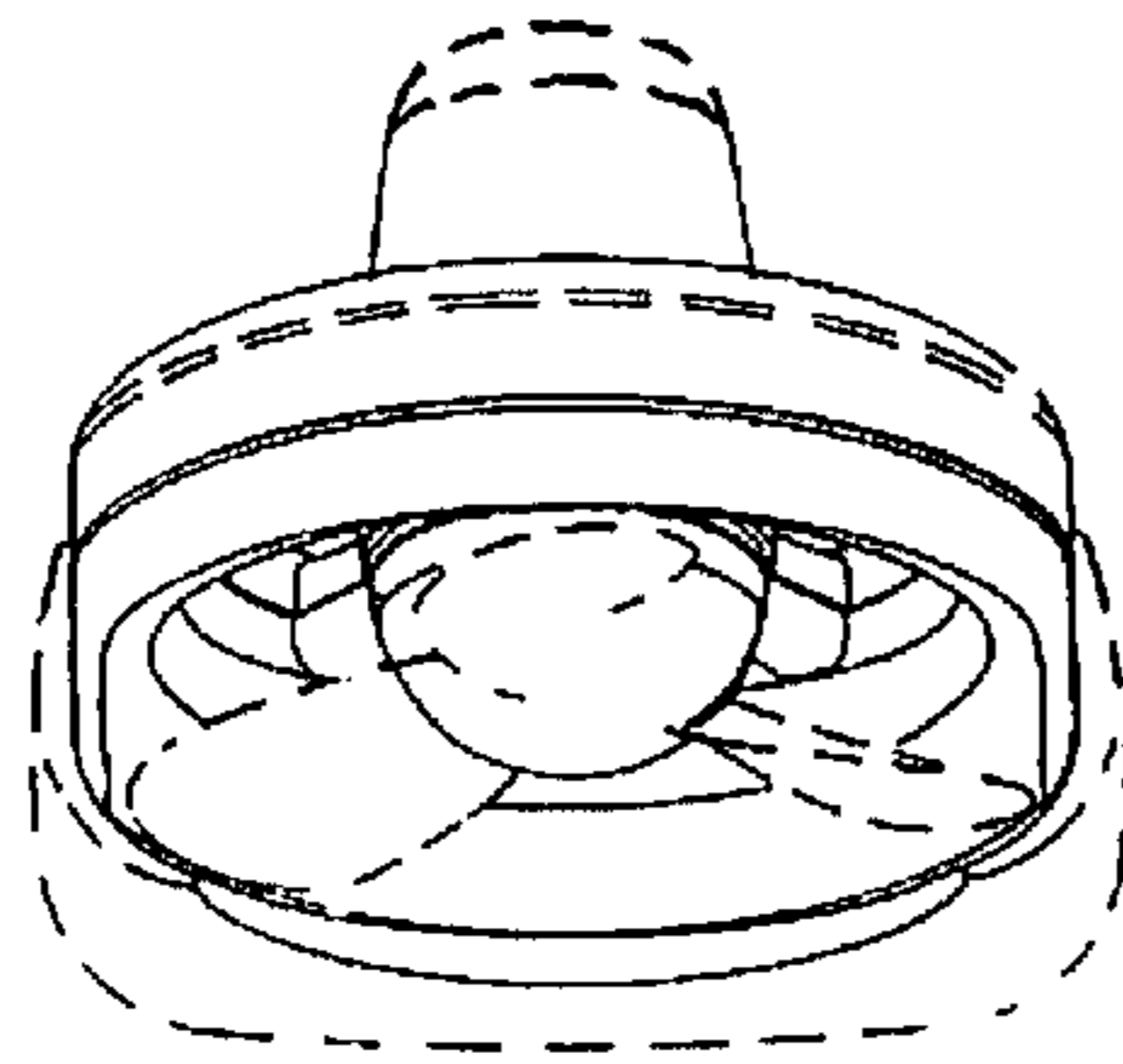

FIG 15

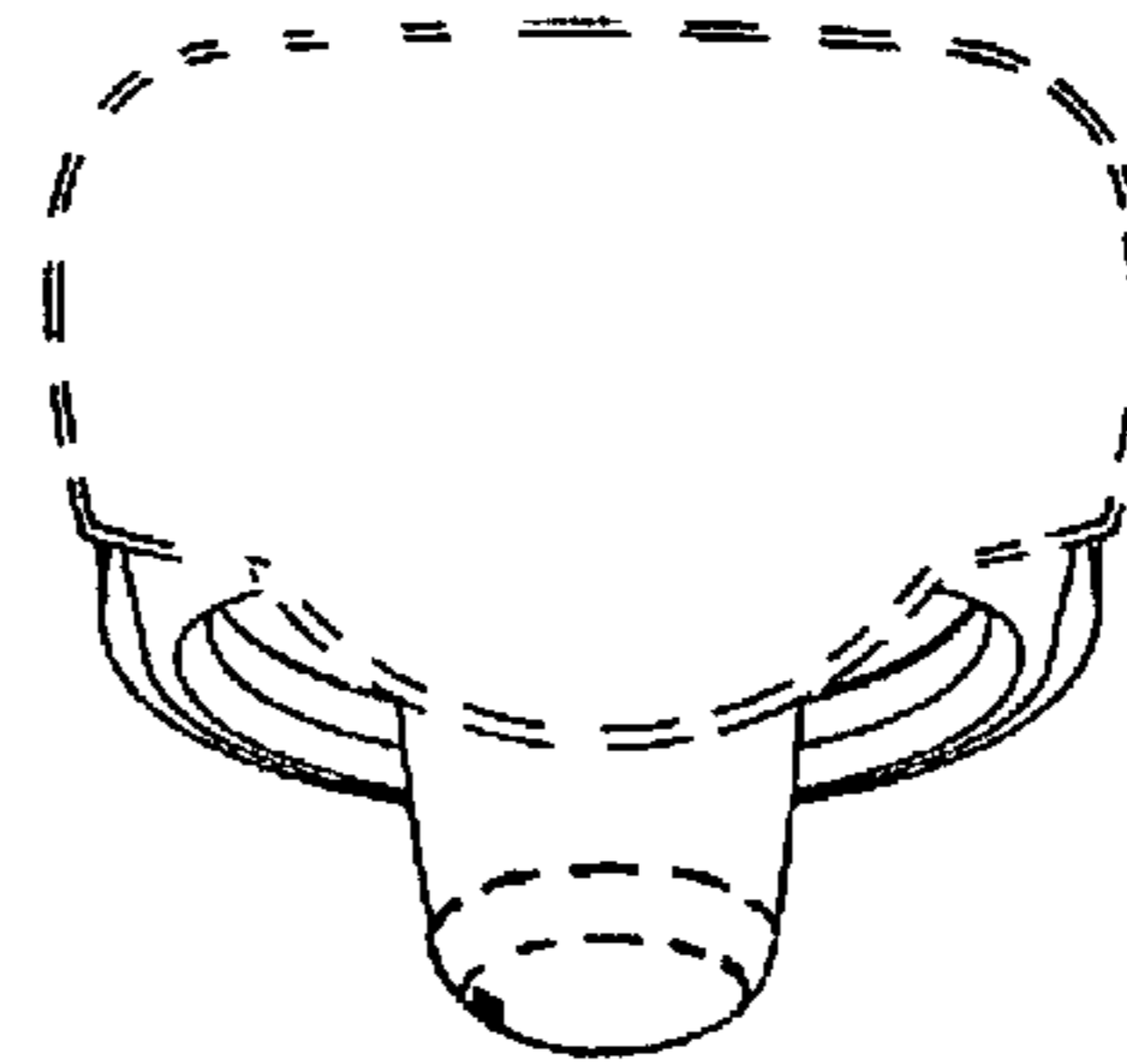

FIG 16

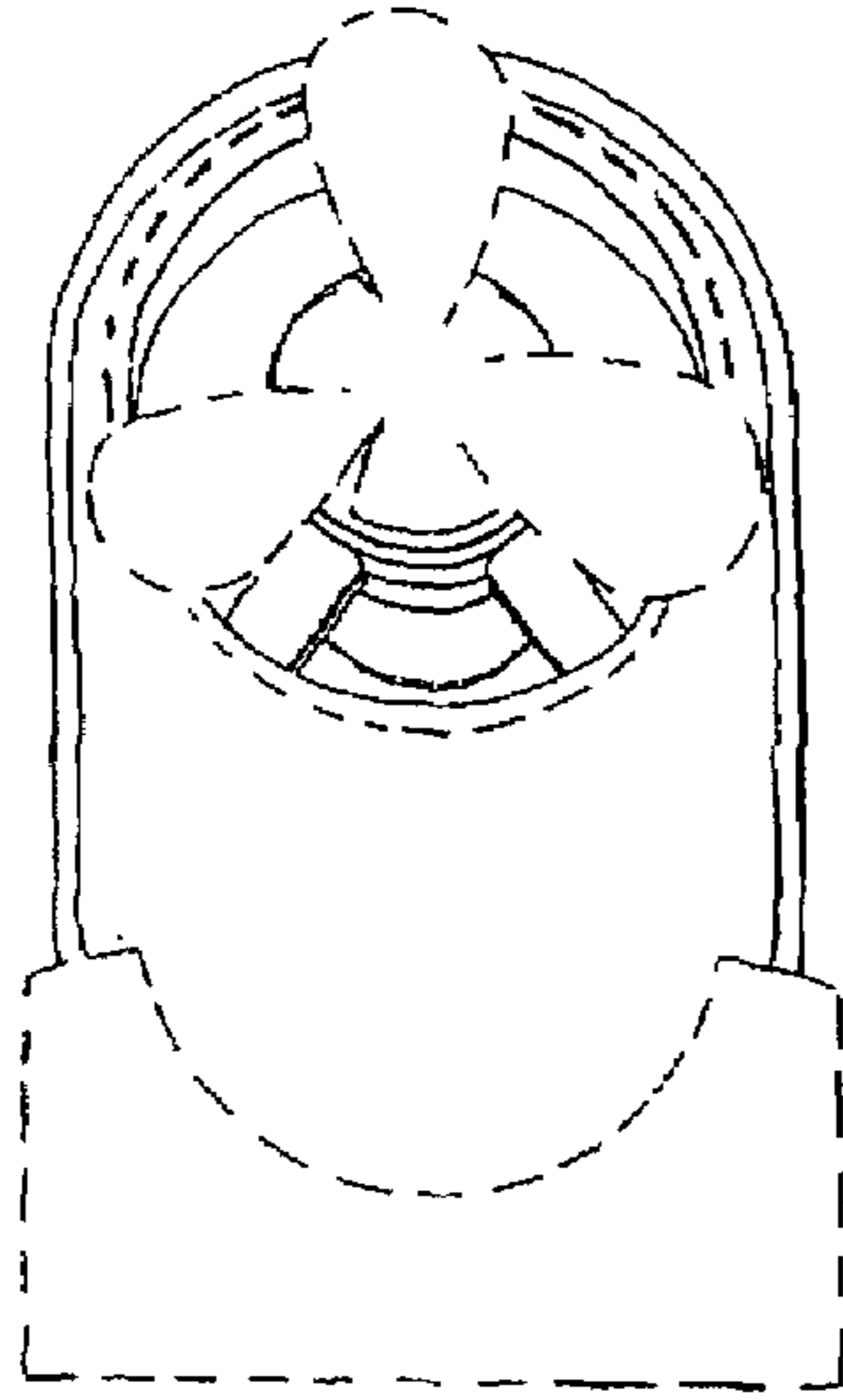

FIG 11

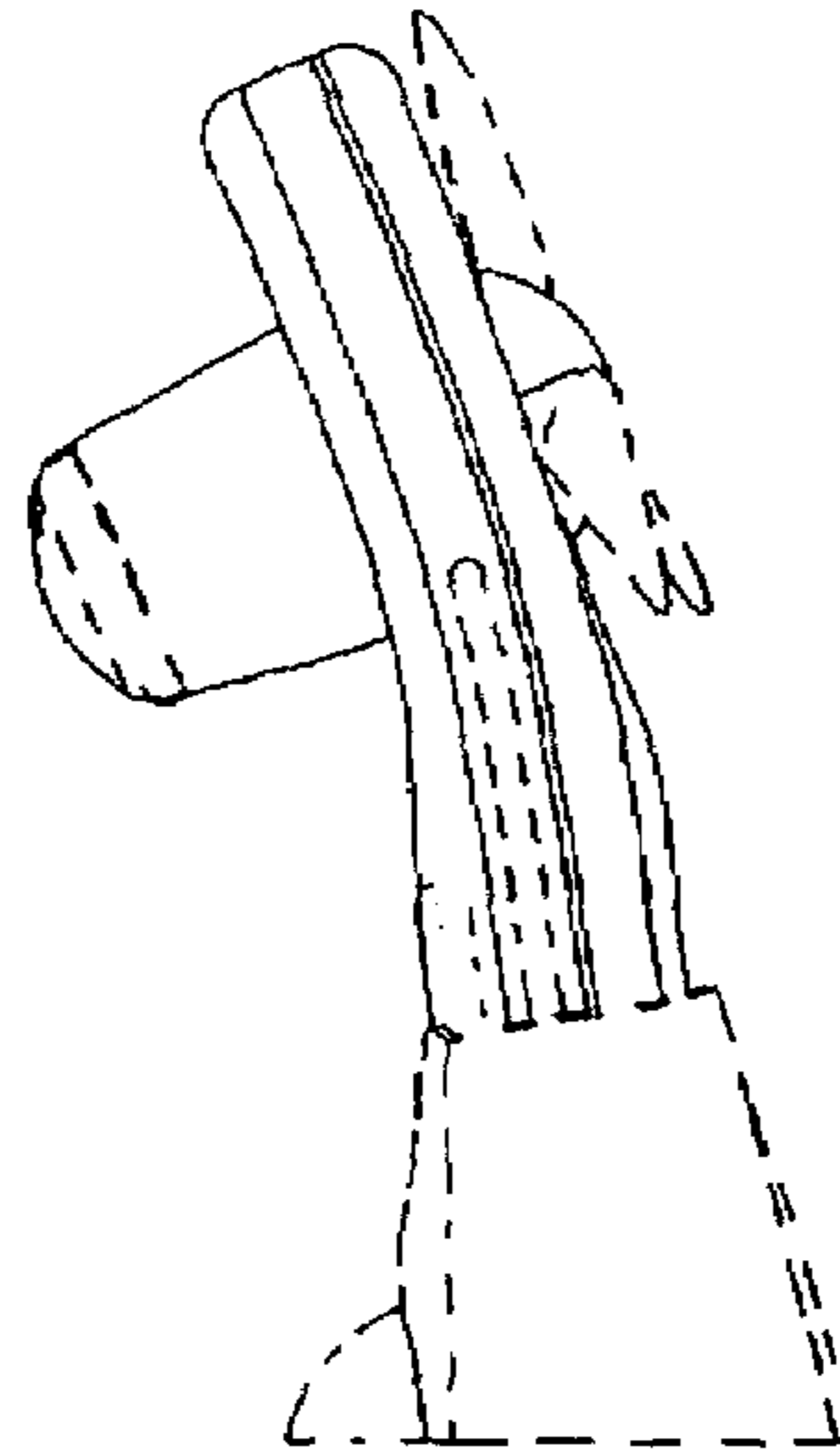

FIG 12

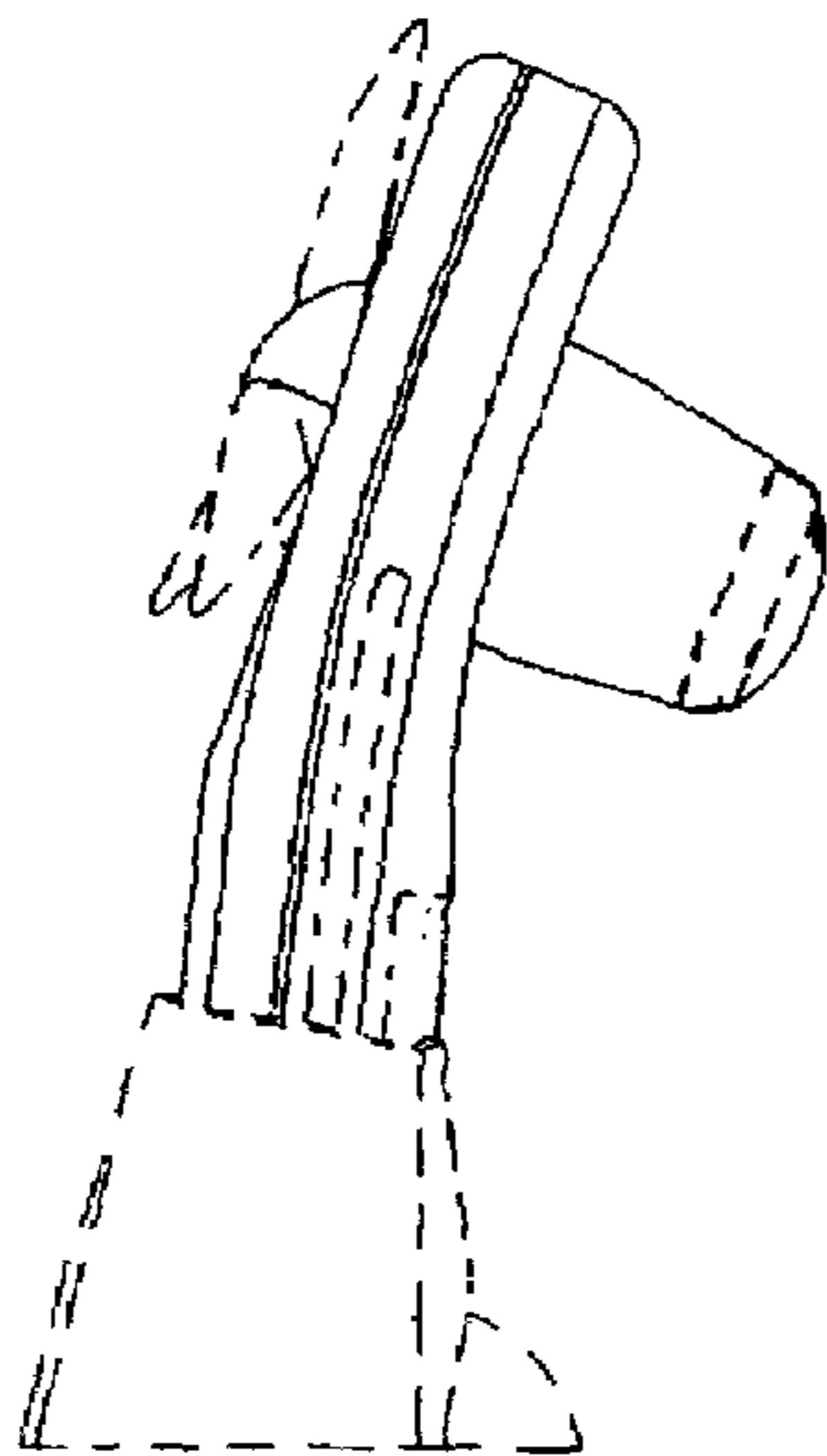

FIG 13

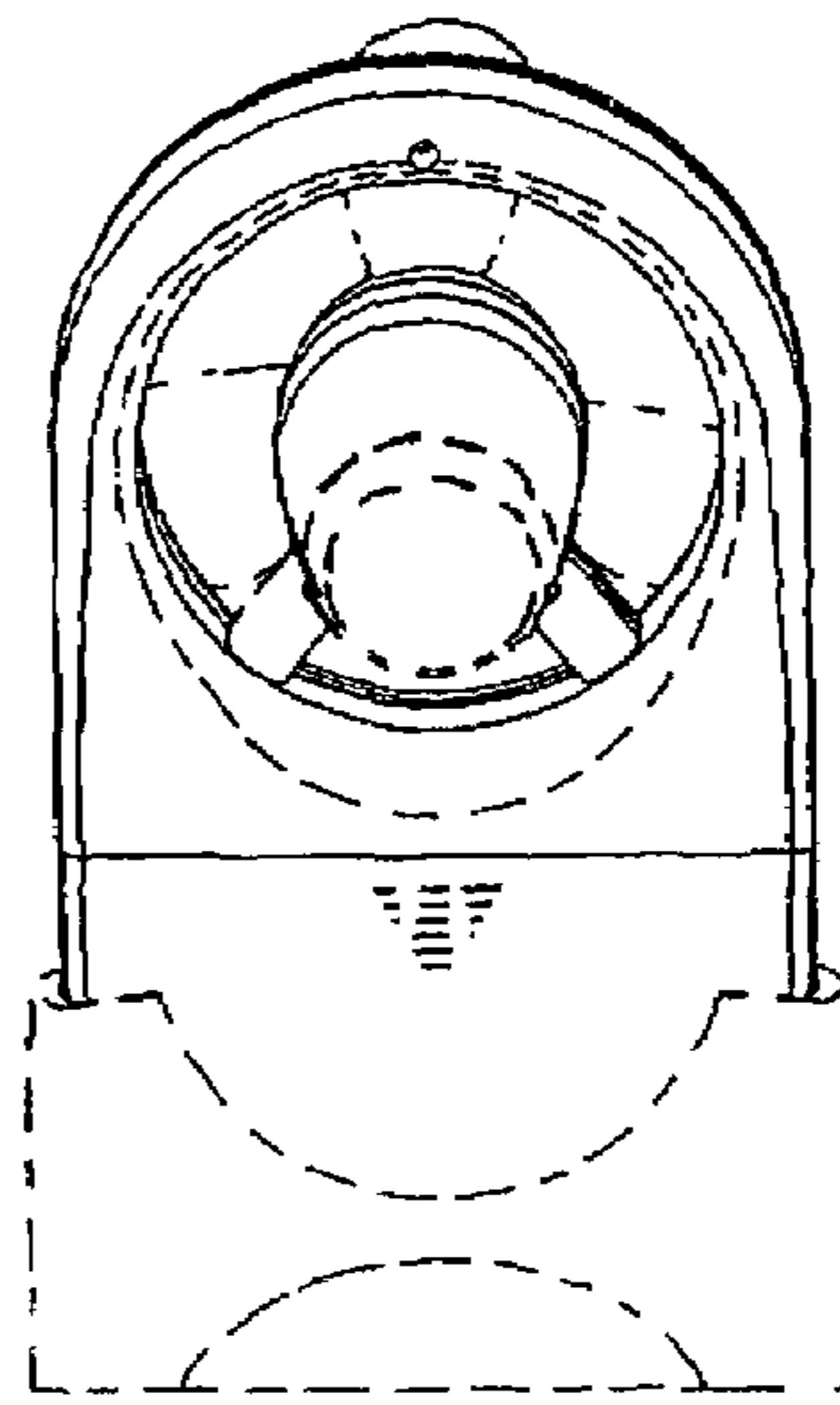

FIG 14